

## Errata

**Title & Document Type:** 3585A Spectrum Analyzer Service Manual, Volume 3

**Manual Part Number:** 03585-90006V3

**Revision Date:** August 1, 1981

---

### HP References in this Manual

This manual may contain references to HP or Hewlett-Packard. Please note that Hewlett-Packard's former test and measurement, semiconductor products and chemical analysis businesses are now part of Agilent Technologies. We have made no changes to this manual copy. The HP XXXX referred to in this document is now the Agilent XXXX. For example, model number HP8648A is now model number Agilent 8648A.

### About this Manual

We've added this manual to the Agilent website in an effort to help you support your product. This manual provides the best information we could find. It may be incomplete or contain dated information, and the scan quality may not be ideal. If we find a better copy in the future, we will add it to the Agilent website.

### Support for Your Product

Agilent no longer sells or supports this product. You will find any other available product information on the Agilent Test & Measurement website:

[www.tm.agilent.com](http://www.tm.agilent.com)

Search for the model number of this product, and the resulting product page will guide you to any available information. Our service centers may be able to perform calibration if no repair parts are needed, but no other support from Agilent is available.



**SERVICE MANUAL**

**MODEL 3585A**

**SPECTRUM ANALYZER**

Serial Numbers: 1750A00716 and greater

**WARNING**

*To help minimize the possibility of electrical fire or shock hazards, do not expose this instrument to rain or excessive moisture.*

**VOLUME III**

Manual Part No. 03585-90006

Microfiche Part No. 03585-90056

©Copyright Hewlett-Packard Company 1979  
P.O. Box 301, Loveland, Colorado, 80537 U.S.A.

Printed: August 1981

# **HP MANUAL SCANS**

**By**

***Artek Media***

1042 Plummer Cir. SW  
Rochester, MN 55902

[www.artekmedia.com](http://www.artekmedia.com)

"High resolution scans of obsolete technical manuals"

**ALL HP MANUALS ARE REPRODUCED  
WITH PERMISSION OF  
AGILENT TECHNOLOGIES INC.**

**Reproduction of this scanned document or removal of this disclaimer  
Will be considered in violation of both Agilent's and Artek Media's copy rights**

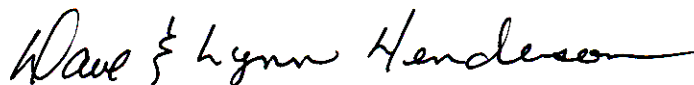
If your looking for a quality scanned technical manual in PDF format please visit our WEB site at [www.artekmedia.com](http://www.artekmedia.com) or drop us an email at [manuals@artekmedia.com](mailto:manuals@artekmedia.com) and we will be happy to email you a current list of the manuals we have available.

If you don't see the manual you need on the list drop us a line anyway we may still be able to point you to other sources. If you have an existing manual you would like scanned please write for details, This can often be done very reasonably in consideration for adding your manual to our library.

Typically the scans in our manuals are done as follows;

- 1) Typed text pages are typically scanned in black and white at 300 dpi.
- 2) Photo pages are typically scanned in gray scale mode at 600 dpi
- 3) Schematic diagram pages are typically scanned in black and white at 600 dpi unless the original manual had colored high lighting (as is the case for some 70's vintage Tektronix manuals).

Thanks



Dave & Lynn Henderson  
Artek Media



**HEWLETT  
PACKARD**

### **CERTIFICATION**

*Hewlett-Packard Company certifies that this product met its published specifications at the time of shipment from the factory. Hewlett-Packard further certifies that its calibration measurements are traceable to the United States National Bureau of Standards, to the extent allowed by the Bureau's calibration facility, and to the calibration facilities of other International Standards Organization members.*

### **WARRANTY**

This Hewlett-Packard product is warranted against defects in material and workmanship for a period of one year from date of shipment [ ,except that in the case of certain components listed in Section I of this manual, the warranty shall be for the specified period] . During the warranty period, Hewlett-Packard Company will, at its option, either repair or replace products which prove to be defective.

For warranty service or repair, this product must be returned to a service facility designated by -hp-. Buyer shall prepay shipping charges to -hp- and -hp- shall pay shipping charges to return the product to Buyer. However, Buyer shall pay all shipping charges, duties, and taxes for products returned to -hp- from another country.

Hewlett-Packard warrants that its software and firmware designated by -hp- for use with an instrument will execute its programming instructions when properly installed on that instrument. Hewlett-Packard does not warrant that the operation of the instrument, or software, or firmware will be uninterrupted or error free.

### **LIMITATION OF WARRANTY**

The foregoing warranty shall not apply to defects resulting from improper or inadequate maintenance by Buyer, Buyer-supplied software or interfacing, unauthorized modification or misuse, operation outside of the environmental specifications for the product, or improper site preparation or maintenance.

**NO OTHER WARRANTY IS EXPRESSED OR IMPLIED. HEWLETT-PACKARD SPECIFICALLY DISCLAIMS THE IMPLIED WARRANTIES OF MERCHANTABILITY AND FITNESS FOR A PARTICULAR PURPOSE.**

### **EXCLUSIVE REMEDIES**

**THE REMEDIES PROVIDED HEREIN ARE BUYER'S SOLE AND EXCLUSIVE REMEDIES. HEWLETT-PACKARD SHALL NOT BE LIABLE FOR ANY DIRECT, INDIRECT, SPECIAL, INCIDENTAL, OR CONSEQUENTIAL DAMAGES, WHETHER BASED ON CONTRACT, TORT, OR ANY OTHER LEGAL THEORY.**

### **ASSISTANCE**

*Product maintenance agreements and other customer assistance agreements are available for Hewlett-Packard products.*

*For any assistance, contact your nearest Hewlett-Packard Sales and Service Office. Addresses are provided at the back of this manual.*

**VOLUME I  
TABLE OF CONTENTS**

Section

- I. GENERAL INFORMATION
- II. INSTALLATION AND INTERFACE
- III. OPERATING INSTRUCTIONS
- IV. PERFORMANCE TESTS
- V. ADJUSTMENTS
- VI. CIRCUIT FUNCTIONAL DESCRIPTIONS
- VII. BACKDATING

**VOLUME II  
TABLE OF CONTENTS**

Section

- VIII. FAULT ISOLATION
- IX. REPLACEABLE PARTS
- X. SCHEMATICS

**VOLUME III  
TABLE OF CONTENTS**

Section	Page	Section	Page
XI. SERVICE .....	11-1	Service Group B-3 - Step Loop	
11-1. Introduction .....	11-1	Synthesizer (A23,A26) .....	11-173/11-174
11-3. What Service Groups Contain.....	11-2	Service Group B-4 - Fractional N	
11-5. Getting Started.....	11-2	Synthesizer (A31-33).....	11-183/11-184
11-8. Things To Remember.....	11-2	Service Group B-5 - LO Control	
11-9. Test Modes.....	11-3	(A34) .....	11-209
3585A Preliminary Troubleshooting		Service Group C - Central	
Procedure .....	11-11	Processor (A41-43,45,47).....	11-223/11-224
Service Group A - RF/IF		Service Group D - Display	
(A1-A16) .....	11-33	(A61,63-67) .....	11-287/11-288
Service Group A-1 - Input Section		Service Group D-1 - Clock	
(A1) .....	11-35/11-36	(A61) .....	11-291/11-292
Service Group A-2 - Conversion		Service Group D-2 - Display Processor	
Section (A2,3,4,5).....	11-75/11-76	(A63) .....	11-295/11-296
Service Group A-3 - Final If Section		Service Group D-3 - Analog Display	
(A17, 18 and 19).....	11-81	Driver (A64).....	11-309/11-310
Service Group A-4 - Log Amplifier		Service Group D-4 - XYZ Amplifiers	
(A14) .....	11-119/11-120	(A67) .....	11-319
Service Group A-5 - Video Filter		Service Group E - Tracking	
(A15) .....	11-123	Generator (A51-3).....	11-327/11-328
Service Group A-6 - Analog-To-Digital		Service Group F - HP-IB	
Converter (A16).....	11-135/11-136	(A44) .....	11-335
Service Group B - Local Oscillator		Service Group G - Counter	
(A21-34) .....	11-149/11-150	(A46) .....	11-351/33-352
Service Group B-1 - Reference		Service Group H - Plotter	
Section (A21,81).....	11-153/11-154	(A62,63).....	11-357/11-358
Service Group B-2 - Sum Loop		Service Group I - Power Supplies	
(A22,24,25,27,28).....	11-161/11-162	(A70-76).....	11-363/11-364
		Service Group J - Distortion and	
		Spurs .....	11-389

## LIST OF SCHEMATICS

Board Designator	SG/Schematic Number	Board Name	Page (Volume II)
A1	A-1a	Input/Conversion	10-5/10-6
A1	A-1b	Input/Conversion	10-7/10-8
A2-A5	A-2	Conversion Section	10-9/10-10
A14	A-4	Log Amplifier	10-17/10-18
A15	A-5	Video Filter	10-19/10-20
A16	A-6	Analog-To-Digital Converter	10-21
A17	A-3a	IF Filter No. 1	10-11/10-12
A18	A-3b	IF Gain	10-13/10-14
A19	A-3c	IF Filter No. 2	10-15/10-16
A21	B-1a	90/10MHz/Ref	10-23/10-24
A22	B-2a	First LO VTO	10-27/10-28
A23	B-3a	Step Synthesizer VTO	10-37/10-38
A24	B-2b	First LO Buffer	10-29/10-30
A25	B-2c	Sum Loop Mixer	10-31/10-32
A26	B-3b	Step Phase Detector	10-39/10-40
A27	B-2d	First LO VTO Control	10-33/10-34
A28	B-2e	Sum Loop Phase Detector	10-35/10-36
A31	B-4a	VTO and Dividers	10-41
A32	B-4b	Analog	10-43/10-44
A33	B-4c	Divided By N Counter	10-45/10-46
A34	B-5	Interface And Trigger	10-47/10-48
A41	C-1	Central Processor	10-49/10-50
A42	C-2	RAM Board	10-51/10-52
A43	C-3	ROM Board	10-53/10-54
A44	F	HP-IB Interface	10-75/10-76
A45	C-4	I/O Board	10-55/10-56
A45	C-5	I/O Board	10-57/10-58
A46	G-1	Counter	10-77/10-78
A47	C-6	Keyboard	10-59/10-60
A50/A51	E-1	Phase Detector	10-71/10-72
A52/A53	E-2	Tracking Generator/100.35MHz VCO	10-73/10-74
A61	D-1	Clock Generator	10-61/10-62
A62	H	X-Y Plotter	10-79/10-80
A63	D-2	Digital Display Driver	10-63/10-64
A64	D-3	Analog Display Driver	10-65/10-66
A65/A66	D-4b	Hi Voltage Board	10-69/10-70
A67	D-4a	XYZ Board	10-67/10-68
A71	I-2a	+ 7.7V Power Supply	10-85/10-86
A72	I-2b	+ 5V Power Supply	10-87/10-88
A73	I-2c	+ 18V, + 12V Power Supply	10-89/10-90
A74	I-2d	- 18V Power Supply	10-91/10-92
A75	I-1a	Power Supply Control	10-81/10-82
A76	I-1b	Power Distribution	10-83/10-84
A81	B-1b	Oven Oscillator	10-25/10-26

**LIST OF TROUBLESHOOTING TREES**

Troubleshooting Tree	Page	Troubleshooting Tree	Page
Main Signal Path.....	11-19/11-20	A81 Oven Reference.....	11-159/11-160
Input Section (A1).....	11-39/11-40	Sum Loop.....	11-163/11-164
A1 Power Supply.....	11-41/11-42	A22 First LO VTO.....	11-165/11-166
A1 Terminated Input Attenuator.....	11-43/11-44	A25 Sum Loop Mixer.....	11-167/11-168
A1 Frequency Response.....	11-45/11-46	A27 First LO VTO Control.....	11-169/11-170
A1 Main Signal Path.....	11-47/11-48	A28 Sum Loop Phase Detector.....	11-171/11-172
A1 Calibrator.....	11-49/11-50	Step Loop Synthesizer (A23,26).....	11-175/11-176
A1 1M Ohm Channel.....	11-51/11-52	A26 Mixer Circuitry.....	11-177
A1 Protection Circuit.....	11-53/11-54	A26 Reference Divider.....	11-178
A1 Autorange.....	11-55/11-56	A26 Divide-By-N.....	11-179/11-180
A1 11dB Gain Amp.....	11-57/11-58	A23 Step Synthesizer VTO.....	11-181/11-182
A1 1M Ohm Buffer.....	11-59/11-60	Fraction N Synthesizer (A31-33).....	11-185/11-186
A1 Output Buffer.....	11-61/11-62	A31 Divide By 4.....	11-187
A1 I/O, Logic and Relay Drive.....	11-63/11-64	A31 Divide By 20.....	11-188
K1 Logic and Drive Circuitry.....	11-65/11-66	A31 VTO Control (HSLSCN).....	11-189/11-190
K3 Logic and Drive Circuitry.....	11-67/11-68	A31 VTO.....	11-191/11-192
K2, K4 Logic and Drive Circuitry.....	11-69/11-70	A32 Fractional N Analog Circuits.....	11-193/11-194
Range Switching (K5—K13) Logic and Drive Circuitry.....	11-71/11-72	A32 Sample and Hold.....	11-195/11-196
K14 Drive Circuitry.....	11-73/11-74	A32 API.....	11-197/11-198
Main Conversion Section.....	11-79/11-80	A33 Fractional N Divider.....	11-199/11-200
Final IF (A17-19).....	11-87/11-88	A33 Pulse Swallow.....	11-201/11-202
A17-19 30KHz BW Main Signal Path.....	11-89/11-90	A33 Divide by 2/3.....	11-203/11-204
A17-19 LC BW Main Signal Path.....	11-91/11-92	A33 Programmable Divide by 5.....	11-205/11-206
A17-19 Crystal BW Main Signal Path.....	11-93/11-94	Lo Control (A34).....	11-212
A17 LC BW Switching.....	11-95/11-96	A34 Line And Ext. Trigger.....	11-213/11-214
A18 LC BW Switching.....	11-97/11-98	A34 Sweep Timing.....	11-215/11-216
A18 LC BW Switching.....	11-99/11-100	A34 Divide By 20.....	11-217/11-218
A17 Crystal BW Switching.....	11-101/11-102	A34 -15V Power Supply.....	11-219
A18 Crystal BW Switching.....	11-103/11-104	A34 5V Power Supply.....	11-220
A19 Crystal BW Switching.....	11-105/11-106	Main Central Processor.....	11-225/11-226
IF Attenuator.....	11-107/11-108	Main Display.....	11-289/11-290
Log Amplifier (A14).....	11-121/11-122	A61 Clock Generator.....	11-293/11-294
Video Filter (A15).....	11-124	A64 Analog Display Driver.....	11-311/11-312
A15 Video Bandwidth Switching.....	11-125/11-126	A64 Sampling.....	11-313
A15 dB/DIV Scaling.....	11-127/11-128	A64 Ramp Generator.....	11-315/11-316
A15 Main Signal Path.....	11-129/11-130	A64 Y-axis Line Drawer.....	11-317/11-318
A15 Reference Level dc Offset.....	11-131/11-132	Main Tracking Generator.....	11-329/11-330
Analog-To-Digital Converter (A16).....	11-137/11-138	A52 Mixer and Output Amplifier.....	11-331/11-332
A16 Main Signal Path.....	11-139/11-140	A53 100.35MHz Oscillator.....	11-333
A16 Sample and Hold.....	11-141/11-142	A46 Main Counter.....	11-353/11-354
A16 Peak Detector.....	11-143/11-144	A46 Ripple Counter.....	11-355/11-356
A16 Amplitude Offset.....	11-145/11-146	A62 Plotter (X and Y Outputs).....	11-359/11-360
A16 Power Supply.....	11-147/11-148	A63 Z Output.....	11-361/11-362
Main Local Oscillator.....	11-151/11-152	Main Power Supply.....	11-365/11-366
Reference Section (A21,A81).....	11-155/11-156	A75 Power Supply Control and Power Transformer.....	11-367/11-368
Reference Section (A21,A81).....	11-157/11-158		



## LIST OF TABLES

Table	Page	Table	Page
11-P-1. Test Mode Definitions . . . . .	11-3	11-C-20. IF/Video Filter - Secondary Signatures . . . . .	11-256
11-P-2. PC Board To Service Group Cross Reference . . . . .	11-4	11-C-21. Local Oscillator - Primary Signatures . . . . .	11-257
11-P-3. Performance Test Failure To Service Group Cross Reference . . . . .	11-5	11-C-22. Local Oscillator - Secondary Signatures . . . . .	11-257
11-P-4. Calibration Error Definitions . . . . .	11-9	11-C-23. Input Section - Primary Signatures . . . . .	11-258
11-P-5. Calibration Error Action Table . . . . .	11-15	11-C-24. Input Section - Secondary Signatures . . . . .	11-258
11-A-1-1. A1 Board Power Supply Currents . . . . .	11-41/11-42	11-C-25. Tracking Generator - Primary Signatures . . . . .	11-259
11-A-3-1. A17 FET Switch Truth Table . . . . .	11-109	11-C-26. Tracking Generator - Secondary Signatures . . . . .	11-259
11-A-3-2. A18 FET Switch Truth Table . . . . .	11-109	11-C-27. Keyboard - Primary Signatures . . . . .	11-259
11-A-3-3. A19 FET Switch Truth Table . . . . .	11-110	11-C-28. Keyboard - Secondary Signatures . . . . .	11-260
11-A-3-4. Jumper Test Positions . . . . .	11-111	11-C-29. Display - Primary Signatures . . . . .	11-260
11-A-3-5. Crystal Padding Resistors . . . . .	11-117	11-C-30. Display - Secondary Signatures . . . . .	11-261
11-A-3-6. Crystal and Padding Resistor Numbers . . . . .	11-118	11-C-31. IOD Bus - Primary Signatures . . . . .	11-262
11-B-1. LO Troubleshooting Table . . . . .	11-149/11-150	11-C-32. IOD Bus - Secondary Signatures . . . . .	11-263/11-264
11-B-5-1. LO Loop Lock Indicator Truth Table . . . . .	11-221/11-222	11-C-33. CRT Test Pattern - Primary Signatures . . . . .	11-267/11-268
11-B-5-2. LO Loop Lock Indicator Failure Table . . . . .	11-221/11-222	11-C-34. CRT Test Pattern - Secondary Signatures . . . . .	11-267/11-268
11-C-1. Digital Section Mnemonic Table . . . . .	11-227	11-C-35. Front Panel Switch Signatures . . . . .	11-276
11-C-2. Processor/Memory I/O Primary Signatures . . . . .	11-230	11-C-36. Keyboard I/O Buffer Check . . . . .	11-277
11-C-3. Processor/Memory I/O Secondary Signatures . . . . .	11-230	11-C-37. Keyboard Matrix Output Line Test . . . . .	11-277
11-C-4. Processor Self Test IDA Bus Signatures . . . . .	11-232	11-C-38. Keyboard Matrix . . . . .	11-278
11-C-5. Memory Control Output Signatures . . . . .	11-234	11-C-39. Keyboard LED Test - Primary Signatures . . . . .	11-280
11-C-6. Processor I/O Control Lines Primary Signatures . . . . .	11-236	11-C-40. Keyboard LED Test - Secondary Signatures . . . . .	11-280
11-C-7. Processor I/O Control Lines Secondary Signatures . . . . .	11-236	11-D-1. Display Processor Kernal Test Signatures . . . . .	11-298
11-C-8. ROM Checksum Signatures . . . . .	11-238	11-D-2. Display Processor Alphanumerics - Primary Signatures . . . . .	11-301
11-C-9. ROM Error Troubleshooting . . . . .	11-238	11-D-3. Display Processor Graphics - Primary Signatures . . . . .	11-301
11-C-10. RAM DSA Test - Part A Primary Signatures . . . . .	11-244	11-D-4. Display Processor - Secondary Signatures . . . . .	11-301
11-C-11. RAM DSA Test - Part A Secondary Signatures . . . . .	11-245	11-D-5. Display Processor Input Buffers . . . . .	11-306
11-C-12. RAM DSA Test - Part B Secondary Signatures . . . . .	11-246	11-F-1. DSA Test 1 Problem Table . . . . .	11-337/11-338
11-C-14. RAM Refresh Multiplexer/Counter DSA Test . . . . .	11-248	11-F-2. DSA Test 2 Signature Table . . . . .	11-339
11-C-15. ROM Address Latch Signatures . . . . .	11-250	11-F-3. Probable Defects For Interface Circuitry Inputs . . . . .	11-346
11-C-16. Revision B ROM's . . . . .	11-251	11-F-4. HP-IB Calculator Test Error Definitions . . . . .	11-347
11-C-17. Revision C ROM's . . . . .	11-252	11-F-5. HP-IB Check Program Listing For The 9825A Calculator . . . . .	11-348
11-C-18. ROM Data Signatures . . . . .	11-254		
11-C-19. IF/Video Filter - Primary Signatures . . . . .	11-256		

\*Table 11-C-13 has been deleted.

## INDEX TO TROUBLESHOOTING INFORMATION

Troubleshooting Information Title	Service Group	Page Number
Test Mode Definitions	Preliminary	11-3
PC Board to Service Group Cross-Reference	Preliminary	11-4
Performance Test Failure to Service Group Cross-Reference	Preliminary	11-5
Calibration Sequence Flowchart	Preliminary	11-6
Calibration System Block Diagram	Preliminary	11-7
Calibration Error Definitions	Preliminary	11-9
3585A Preliminary Troubleshooting Procedure	Preliminary	11-11
Calibration Error Action Table	Preliminary	11-15
Input Section (A1) Troubleshooting	A-1	11-35
Conversion Section (A2-5) Troubleshooting	A-2	11-75
Final IF Section (A17-19) Troubleshooting	A-3	11-81
Log Amplifier (A14) Troubleshooting	A-4	11-119
Video Filter (A15) Troubleshooting	A-5	11-123
Analog-to-Digital Converter (A16) Troubleshooting	A-6	11-135
Input Section (A1) Troubleshooting Tree	A-1	11-39
A1 Power Supply Troubleshooting Tree	A-1	11-41
A1 Terminated Input Attenuator Troubleshooting Tree	A-1	11-43
A1 Frequency Response Troubleshooting Tree	A-1	11-45
A1 Main Signal Path Troubleshooting Tree	A-1	11-47
A1 Calibrator Troubleshooting Tree	A-1	11-49
A1 1M Ohm Channel Troubleshooting Tree	A-1	11-51
A1 Protection Circuit Troubleshooting Tree	A-1	11-53
A1 Autorange Troubleshooting Tree	A-1	11-55
A1 11dB Gain Amp Troubleshooting Tree	A-1	11-57
A1 1M Ohm Buffer Troubleshooting Tree	A-1	11-59
A1 Output Buffer Troubleshooting Tree	A-1	11-61
A1 I/O, Logic and Relay Driver Troubleshooting Tree	A-1	11-63
Main Conversion Section Troubleshooting Tree	A-2	11-75
Final IF (A17-19) Troubleshooting Tree	A-3	11-87
A17-19 30kHz BW Main Signal Path Troubleshooting Tree	A-3	11-89
A17-19 LC BW Main Signal Path Troubleshooting Tree	A-3	11-91
A17-19 Crystal BW Main Signal Path Troubleshooting Tree	A-3	11-93
A17 LC BW Switching Troubleshooting Tree	A-3	11-95
A18 LC BW Switching Troubleshooting Tree	A-3	11-97
A19 LC BW Switching Troubleshooting Tree	A-3	11-99
A17 Crystal BW Switching Troubleshooting Tree	A-3	11-101
A18 Crystal BW Switching Troubleshooting Tree	A-3	11-103
A19 Crystal BW Switching Troubleshooting Tree	A-3	11-105
IF Attenuator Troubleshooting Tree	A-3	11-107
A17 FET Switch Truth Table	A-3	11-109
A18 FET Switch Truth Table	A-3	11-109
A19 FET Switch Truth Table	A-3	11-110
Crystal Replacement Procedure	A-3	11-117
Log Amplifier (A14) Troubleshooting Tree	A-4	11-121
Video Filter (A15) Troubleshooting Tree	A-5	11-124
A15 Video Bandwidth Switching Troubleshooting Tree	A-5	11-125
A15 dB/DIV Scaling Troubleshooting Tree	A-5	11-127
A15 Main Signal Path Troubleshooting Tree	A-5	11-129
A15 Reference Level dc Offset Troubleshooting Tree	A-5	11-131
A15 Signature Analysis Tests	A-5	11-133

## INDEX TO TROUBLESHOOTING INFORMATION (Cont'd)

Troubleshooting Information Title	Service Group	Page Number
Analog-to-Digital Converter (A16) Troubleshooting Tree	A-6	11-137
A16 Main Signal Path Troubleshooting Tree	A-6	11-139
A16 Sample and Hold Troubleshooting Tree	A-6	11-141
A16 Peak Detector Troubleshooting Tree	A-6	11-143
A16 Amplitude Offset Troubleshooting Tree	A-6	11-145
A16 Power Supply Troubleshooting Tree	A-6	11-147
Main Local Oscillator Troubleshooting Tree	B	11-151
LO Troubleshooting Table	B	11-149
Reference Section (A21,81) Troubleshooting	B-1	11-153
Sum Loop (A22,24,25,27,28) Troubleshooting	B-2	11-161
Step Synthesizer (A23,26) Troubleshooting	B-3	11-173
Fractional N Synthesizer (A31-33) Troubleshooting	B-4	11-183
LO Control (A34) Troubleshooting	B-5	11-209
Reference Section (A21,81) Troubleshooting Tree	B-1	11-155
A81 Oven Reference Troubleshooting Tree	B-1	11-157
Main Sum Loop Troubleshooting Tree	B-2	11-163
A22 First LO VTO Troubleshooting Tree	B-2	11-165
A25 Sum Loop Mixer Troubleshooting Tree	B-2	11-167
A27 First LO VTO Control Troubleshooting Tree	B-2	11-169
A28 Sum Loop Phase Detector Troubleshooting Tree	B-2	11-171
Main Step Loop Synthesizer (A23,26) Troubleshooting Tree	B-3	11-175
A26 Mixer Circuitry Troubleshooting Tree	B-3	11-177
A26 Reference Divider Troubleshooting Tree	B-3	11-178
A26 Divide by N Troubleshooting Tree	B-3	11-179
A23 Step Synthesizer VTO Troubleshooting Tree	B-3	11-181
Main Fractional N Synthesizer (A31-33) Troubleshooting Tree	B-4	11-185
A31 Divide by 4 Troubleshooting Tree	B-4	11-187
A31 Divide by 20 Troubleshooting Tree	B-4	11-188
A31 VTO Control (HSLSCN) Troubleshooting Tree	B-4	11-189
A31 VTO Troubleshooting Tree	B-4	11-191
A32 Fractional N Analog Circuits Troubleshooting Tree	B-4	11-193
A32 Sample and Hold Troubleshooting Tree	B-4	11-195
A32 API Troubleshooting Tree	B-4	11-197
A33 Fractional N Divider Troubleshooting Tree	B-4	11-199
A33 Pulse Swallow Troubleshooting Tree	B-4	11-201
A33 Divide by 2/3 Troubleshooting Tree	B-4	11-203
A33 Programmable Divide by 5 Troubleshooting Tree	B-4	11-205
LO Control Troubleshooting Tree	B-5	11-212
A34 Line And Ext. Trigger Troubleshooting Tree	B-5	11-213
A34 Sweep Timing Troubleshooting Tree	B-5	11-215
A34 Divide By 20 Troubleshooting Tree	G-5	11-217
A34 - 15V Power Supply Troubleshooting Tree	B-5	11-219
A34 5V Power Supply Troubleshooting Tree	B-5	11-220
LO Loop Lock Indicator Truth Table	B-5	11-221
LO Loop Lock Indicator Failure Table	B-5	11-221
Central Processor Troubleshooting Tree	C	11-225
Digital Section Mnemonic Table	C	11-227
Processor/Memory I/O Test	11-C-1-1	11-229
Processor Self Test	11-C-1-2	11-231
Processor Memory Control Test	11-C-1-3	11-233

## INDEX TO TROUBLESHOOTING INFORMATION (Cont'd)

Troubleshooting Information Title	Service Group	Page Number
Processor Memory I/O Control Test	11-C-1-4	11-235
ROM Checksum Test	11-C-2-1	11-237
RAM Refresh Verification	11-C-2-2	11-239
RAM Verification	11-C-2-3	11-241
RAM DSA Test	11-C-2-4	11-243
RAM Refresh ASM Test	11-C-2-5	11-247
ROM Address/Chip Select Test	11-C-2-6	11-249
ROM Data Test	11-C-2-7	11-253
I/O Data Output Test	11-C-3-1	11-255
CRT Test Pattern	11-C-3-2	11-265
DMA Request Circuitry Test	11-C-3-3	11-269
Low Level Interrupt (LDMAIR) Test	11-C-3-4	11-271
High Level Interrupt (HADIR) Test	11-C-3-5	11-273
Keyboard Test	C	11-275
Keyboard LED Test	C	11-279
Keyboard Key Replacement Procedure	C	11-281
Keyboard LED Replacement Procedure	C	11-282
Front Panel "Knob" Troubleshooting Procedure	C	11-283
Main Display Troubleshooting Tree	D	11-289
A61 Clock Generator Troubleshooting Tree	D-1	11-293
A63 Display Processor Kernal Test	D-2-1	11-297
A63 Display Processor Board Tests	D-2-2	11-299
A63 Display Processor Input Buffer Test	D-2-3	11-305
A64 Analog Display Driver Troubleshooting Tree	D-3	11-311
A67 Sampling Troubleshooting Tree	D-3	11-313
A64 Ramp Generator Troubleshooting Tree	D-3	11-315
A64 Y-Axis Line Drawer Troubleshooting Tree	D-3	11-317
A67 X and Y-Axis Deflection Amplifiers	D-4	11-320
A67 Z-Axis Amplifier	D-4	11-320
A67 100V Regulator	D-4	11-320
A67 High Voltage Oscillator	D-4	11-320
A67 CRT Adjustments	D-4	11-321
CRT Replacement Procedure		11-321
Main Tracking Generator Troubleshooting Tree	E	11-329
A52 Mixer and Output Amplifier Troubleshooting Tree	E	11-331
A53 100.35MHz Oscillator Troubleshooting Tree	E	11-333
HP-IB Troubleshooting Procedure	F	11-336
DSA Test 1 Problem Table (Table 11-F-1)	F	11-337
DSA Test 2 Signature Table (Table 11-F-2)	F	11-339
Probable Defects For Interface Circuitry Inputs (Table 11-F-3)	F	11-346
HP-IB Calculator Test	F	11-347
HP-IB Calculator Test Error Definitions (Table 11-F-4)	F	11-347
HP-IB Check Program Listing for the 9825A Calculator (Table 11-F-5).	F	11-348
A46 Main Counter Troubleshooting Tree	G	11-353
A46 Ripple Counter Troubleshooting Tree	G	11-355
A62 Plotter Troubleshooting Tree (X and Y Outputs)	H	11-359
A63 Z Output Troubleshooting Tree	H	11-361

## INDEX TO TROUBLESHOOTING INFORMATION (Cont'd)

Troubleshooting Information Title	Service Group	Page Number
Main Power Supply Troubleshooting Tree	11-I-1	11-365
A75 Power Supply Control and Power Transformer Troubleshooting Tree	11-I-1	11-367
7.7V Power Supply	11-I-2-1	11-369
5V Power Supply	11-I-2-2	11-373
12V Power Supply	11-I-2-3	11-377
18V Power Supply	11-I-2-4	11-381
- 18V Power Supply	11-I-2-5	11-385



**HEWLETT  
PACKARD**

## **SAFETY SUMMARY**

The following general safety precautions must be observed during all phases of operation, service, and repair of this instrument. Failure to comply with these precautions or with specific warnings elsewhere in this manual violates safety standards of design, manufacture, and intended use of the instrument. Hewlett-Packard Company assumes no liability for the customer's failure to comply with these requirements. This is a Safety Class 1 instrument.

### **GROUND THE INSTRUMENT**

To minimize shock hazard, the instrument chassis and cabinet must be connected to an electrical ground. The instrument is equipped with a three-conductor ac power cable. The power cable must either be plugged into an approved three-contact electrical outlet or used with a three-contact to two-contact adapter with the grounding wire (green) firmly connected to an electrical ground (safety ground) at the power outlet. The power jack and mating plug of the power cable meet International Electrotechnical Commission (IEC) safety standards.

### **DO NOT OPERATE IN AN EXPLOSIVE ATMOSPHERE**

Do not operate the instrument in the presence of flammable gases or fumes. Operation of any electrical instrument in such an environment constitutes a definite safety hazard.

### **KEEP AWAY FROM LIVE CIRCUITS**

Operating personnel must not remove instrument covers. Component replacement and internal adjustments must be made by qualified maintenance personnel. Do not replace components with power cable connected. Under certain conditions, dangerous voltages may exist even with the power cable removed. To avoid injuries, always disconnect power and discharge circuits before touching them.

### **DO NOT SERVICE OR ADJUST ALONE**

Do not attempt internal service or adjustment unless another person, capable of rendering first aid and resuscitation, is present.

### **USE CAUTION WHEN EXPOSING OR HANDLING THE CRT**

Breakage of the Cathode-ray Tube (CRT) causes a high-velocity scattering of glass fragments (implosion). To prevent CRT implosion, avoid rough handling or jarring of the instrument. Handling of the CRT shall be done only by qualified maintenance personnel using approved safety mask and gloves.

### **DO NOT SUBSTITUTE PARTS OR MODIFY INSTRUMENT**

Because of the danger of introducing additional hazards, do not install substitute parts or perform any unauthorized modification to the instrument. Return the instrument to a Hewlett-Packard Sales and Service Office for service and repair to ensure that safety features are maintained.

### **DANGEROUS PROCEDURE WARNINGS**

Warnings, such as the example below, precede potentially dangerous procedures throughout this manual. Instructions contained in the warnings must be followed.

**WARNING**

**Dangerous voltages, capable of causing death, are present in this instrument. Use extreme caution when handling, testing, and adjusting.**



## **CATHODE-RAY TUBE WARRANTY AND INSTRUCTIONS**

The cathode-ray tube (CRT) supplied in your Hewlett-Packard Instrument and replacement CRT's purchased from -hp- are warranted by the Hewlett-Packard Company against electrical failure for a period of one year from the date of shipment from Colorado Springs. Broken tubes and tubes with phosphor or mesh burns are not included under this warranty. No other warranty is expressed or implied.

### **INSTRUCTION TO CUSTOMERS**

If the CRT is broken when received, a claim should be made with the responsible carrier. All warranty claims with Hewlett-Packard should be processed through your nearest Hewlett-Packard Sales/Service Office (listed at rear of instrument manual).

### **INSTRUCTIONS TO SALES/SERVICE OFFICE**

Return defective CRT in the replacement CRT packaging material. If packaging material is not available, contact CRT Customer Service in Colorado Springs. The Colorado Springs Division must evaluate all CRT claims for customer warranty, Material Failure Report (MFR) credit, and Heart System credit. A CRT Failure Report form (see reverse side of this page) must be completely filled out and sent with the defective CRT to the following address:

**HEWLETT-PACKARD COMPANY**  
1900 Garden of the Gods Road  
Colorado Springs, Colorado 80907

**Parcel Post Address:**  
P.O. Box 2197  
Colorado Springs, Colorado 80901

Attention: CRT Customer Service

Defective CRT's not covered by warranty may be returned to Colorado Springs for disposition. These CRT's, in some instances, will be inspected and evaluated for reliability information by our engineering staff to facilitate product improvements. The Colorado Springs Division is equipped to safely dispose of CRT's without the risks involved in disposal by customers or field offices. If the CRT is returned to Colorado Springs for disposal and no warranty claim is involved, write "Returned for Disposal Only" in item No. 5 on the form.

Do not use this form to accomplish CRT repairs. In order to have a CRT repaired, it must be accompanied by a customer service order (repair order) and the shipping container must be marked "Repair" on the exterior.

## SECTION XI SERVICE

**WARNING**

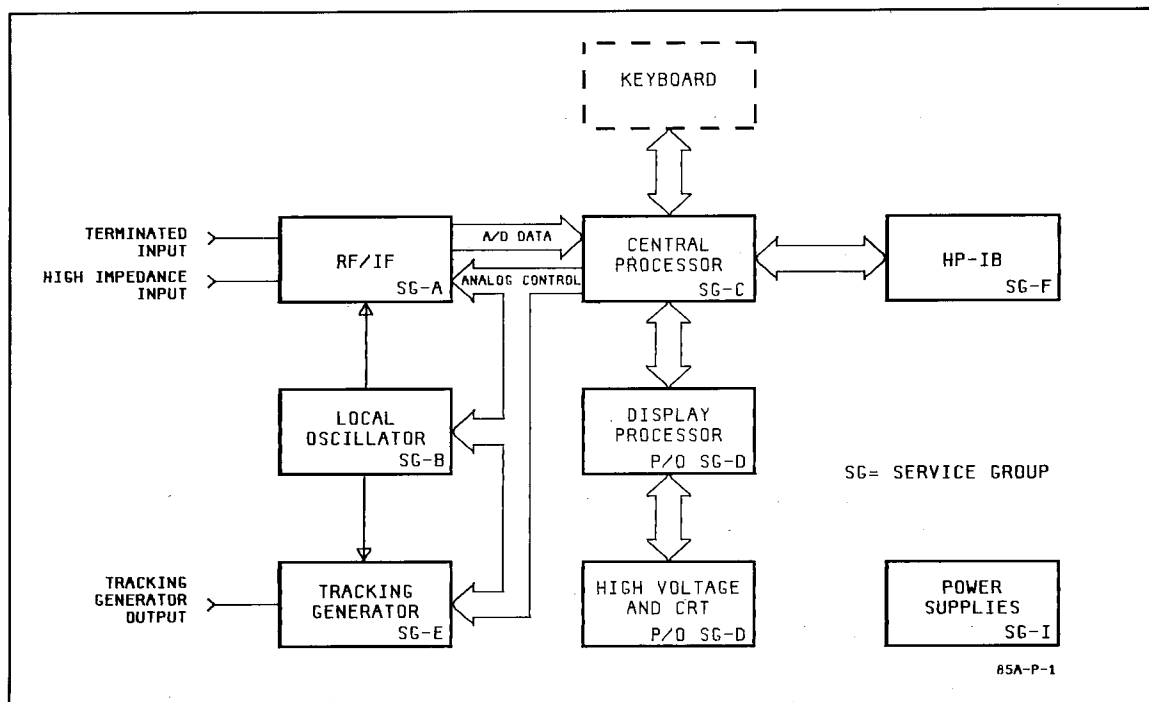
*Line voltage is exposed inside the instrument even when the LINE switch is in the off position.*

*The display section of the 3585A contains high voltages (up to +18KV) which may remain present in circuits EVEN WHEN THE INSTRUMENT IS OFF.*

*Do not remove any of the instruments protective plastic covers before reading the warnings pertaining to the components under them.*

### 11-1. INTRODUCTION

This section contains information to help you repair the 3585A. Due to the complexity of the instrument, the Service Section is divided up into functional Service Groups. Figure 11-P-1 shows a basic block diagram of the instrument. Each block of the block diagram contains the Service Group number pertaining to that section of the instrument. Also contained in this section is an Index (Table 11-P-6) which tabulates all of the Troubleshooting information contained in Section 11 and Table 11-P-2 which is a cross reference between the PC Board numbers and the Service Group numbers.



**Figure 11-P-1. Very Simplified Block Diagram**



## 11-2. What Service Groups Contain

Each of the Service Groups contains the following information:

- a. Index to the particular Service Group.
- b. Adjustments.
- c. Troubleshooting Notes.
- d. Troubleshooting Information.
- e. Component Locator.

## 11-3. Getting Started

The purpose of this section is to lead you in the repair of your instrument as quickly as possible. To accomplish this goal, a Preliminary Troubleshooting Procedure has been developed. The Preliminary Troubleshooting Procedure primarily consists of front panel checks which will direct you to one of the individual Service Groups after localizing the problem.

One of the advantages of the 3585A microprocessor controlled operation is its ability to check many of its own parameters from the front panel. The Preliminary Troubleshooting Procedure (as well as the Service Groups) takes full advantage of this capability. Therefore, in spite of what problem you may be experiencing with your instrument you should always start with the Preliminary Troubleshooting Procedure.

## 11-4. Things to Remember

1. Whenever you have finished with a PC Board, check that all the test jumpers are in the "Normal" position.
2. After completing a repair or when leaving a Service Group, check that all of the jumpers and test switches have been returned to their normal position.
3. Reconnect all cables when leaving a Service Group.

### NOTE

*Before removing any of the 3585A's covers, be aware of the following cautions:*



1. *Do not remove or replace circuit boards when the LINE switch is on unless specifically instructed to do so.*
2. *Improper adjustment of the CRT HIGH VOLTAGE may lead to a shortened CRT life.*
3. *When placing a PC Board on a PC Extender, be sure the board is not installed backwards on the extender.*

**11-5. Test Modes**

The 3585A contains 9 internal test modes. These test modes allow you to connect internal sources, disable calibration or reconfigure particular circuit boards so that tests can be made on the 3585A. The tests are defined as follows:

**Table 11-P-1. Test Mode Definitions**

Entry Code	A45 Switch Code (Octal)	Function
00	000	Test Modes off.
01	001	Normal instrument operation but with calibration disabled and no calibration offsets.
02	002	Internal 10 MHz switched into input otherwise normal instrument operation.
03	003	Internal 10 MHz switched into input and calibration disabled and no calibration offsets.
04	004	Tracking generator switched into input, otherwise normal operation.
05	005	Tracking generator switched into input; no calibration; no calibration offsets.
06	006	Local oscillator will perform in its single loop mode for all BW's.
07	007	Takes Center Frequency Step Size as a tracking generator offset after a calibration. Tracking generator frequency is set positive with respect to analyzer tuned frequency. Maximum offset is 1.5 kHz.
08	010	Displays the Tracking Generator 10.35 MHz VCXO tuning curve on screen with the vertical scale = CF Step Size. The counter reads frequency deviation above and below 10.35 MHz. A CF Step Size > 500 Hz exercises the course VCXO tuning DAC, while CF Step Sizes ≤ 499 Hz exercise the fine DAC with the course DAC held at its current position. This mode is activated when the counter is turned on and the RES BW being used is calibrated.
09	011	Calibration disabled and no calibration offsets. If CF Step Size is any number other than 1.1 Hz, 1.2 Hz, or 1.3 Hz this mode is the same as Test Mode 1. If CF Step Size is one of the above numbers the P.C. board corresponding to that number will be programmed to the chosen BW while the other two boards will be programmed to 30 kHz BW. This mode is accessed when the RBW is changed. This Test mode is used for adjusting the IF BW's.

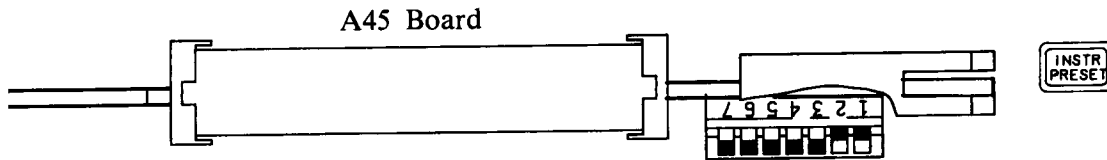
The Test Modes are selected by entering:



Test Mode  
Entry Code

An Instrument Preset must be entered after the Test Mode Entry Code for the Test Mode to become active. The selected Test Mode will remain in effect until Instrument Preset is pressed again.

The Test Modes may also be accessed by setting the test switches on the A45 Board to the listed A45 Switch Code. for example, Test Mode 03 may be placed in effect by:



3585A-1001

Instrument Preset must be pressed to enter the Test Mode. By using the A45 switches the Test Mode will remain in affect as long as the A45 switches are set, in spite of the number of times Instrument Preset is pressed. To exit the Test Mode, set all of the test switches to the open position (away from the PC Board) and pressing Instrument Preset.

**Table 11-P-2. PC Board To Service Group Cross Reference**

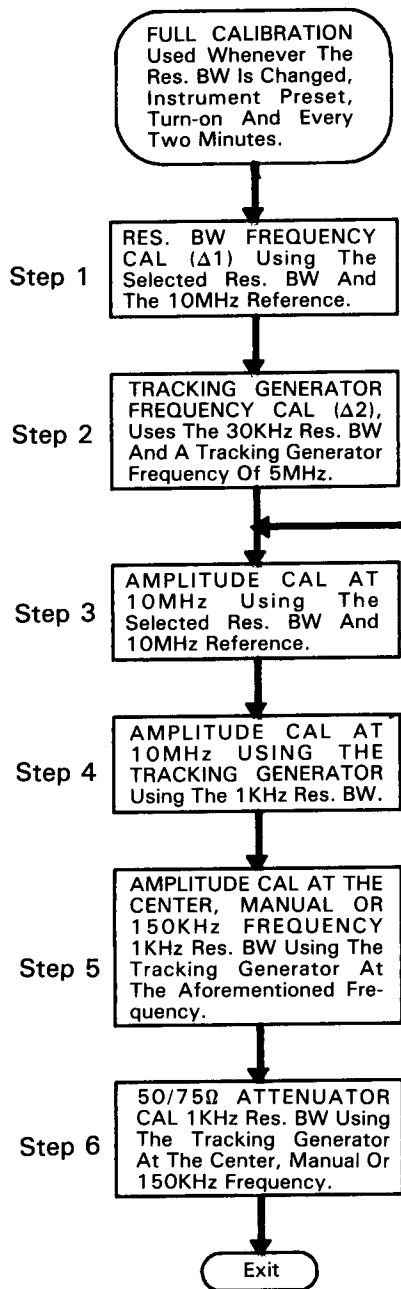
PC Board Number	Service Group Number	PC Board Number	Service Group Number
A1	A-1	A34	B-5
A2	A-2	A40	C
A3	A-2	A41	C-1
A4	A-2	A42	C-2
A5	A-2	A43	C-2
A6	A-2	A44	F
A10	A	A45	C-3
A11	Backdating	A46	G
A12	Backdating	A47	C-4
A13	Backdating	A50	E
A14	A-4	A51	E
A15	A-5	A52	E
A16	A-6	A53	E
A17	A-3	A61	D-1
A18	A-3	A62	H
A19	A-3	A63	D-2
A21	B-1	A64	D-3
A22	B-2	A65	D-4
A23	B-3	A67	D-4
A24	B-2	A70	I-1
A25	B-2	A71	I-2
A26	B-3	A72	I-2
A27	B-2	A73	I-2
A28	B-2	A74	I-2
A31	B-4	A75	I-1
A32	B-4	A76	I-1
A33	B-4	A81	B-1

**Table 11-P-3. Performance Test Failure To Service Group Cross Reference**

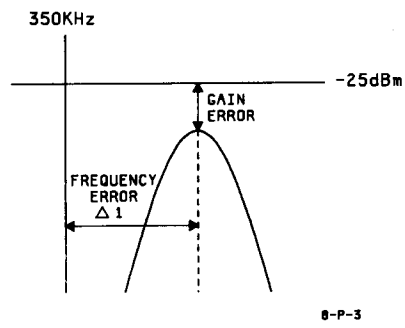
<b>NOTE</b>		
<i>This table is only meant to be a reference. It is still recommended that you use the Preliminary Troubleshooting Procedure to locate the problem. Problems related to distortion or spurs should be further analyzed using Service Group J.</i>		
<b>File</b>	<b>Test Title</b>	<b>Service Group Reference</b>
0	GRIND	NA
1	Instrument interconnect test & Header	NA
2	Turn on/Cal Offset	F,A-5,E,A-1
3	Source Accuracy	NA
4	Calibrator Accuracy (optional)	A-1
5	Range Calibration	A-1
6	Amplitude Linearity	A-4
7	Ref Level Set Accuracy	A-3,A-5
8	Flatness, 50 ohm, no cal, 10Hz to 40M	A-1
9	Flatness, 1M, 20Hz to 40MHz	A-1
10	RETURN LOSS	A-1
11	Noise vs. BANDWIDTH	A-1,A-2
12	1M Input Noise, open circuit	A-1
13	Marker Accuracy	C
14	Low Freq. Response/LO sidebands	A-2,B
15	Residual Spurs	B,J
16	Conv/Input Spurs and Image	A-2,J
17	IF Harmonic Distortion	J
18	Harmonic Distortion	J
19	IM Distortion	J
20	BW MEAS	A-3
21	Tracking Generator Flatness	E
22	Step IF, Fraction N Spurs	J
23	API Spurs in Multiple Loop	J
24	End of Perf. Test message	NA
25	Dynamic Range Chart	NA
26	HP-IB Test for Op. Verification	NA

**NOTE**

*If the Manual or Center Frequency is < 150kHz The Amplitude Cal will occur at 150kHz.*



AMPLITUDE CAL Used Whenever The Center Or Manual Frequency Is Changed And > 150KHz Or The Input Impedance Is Changed.

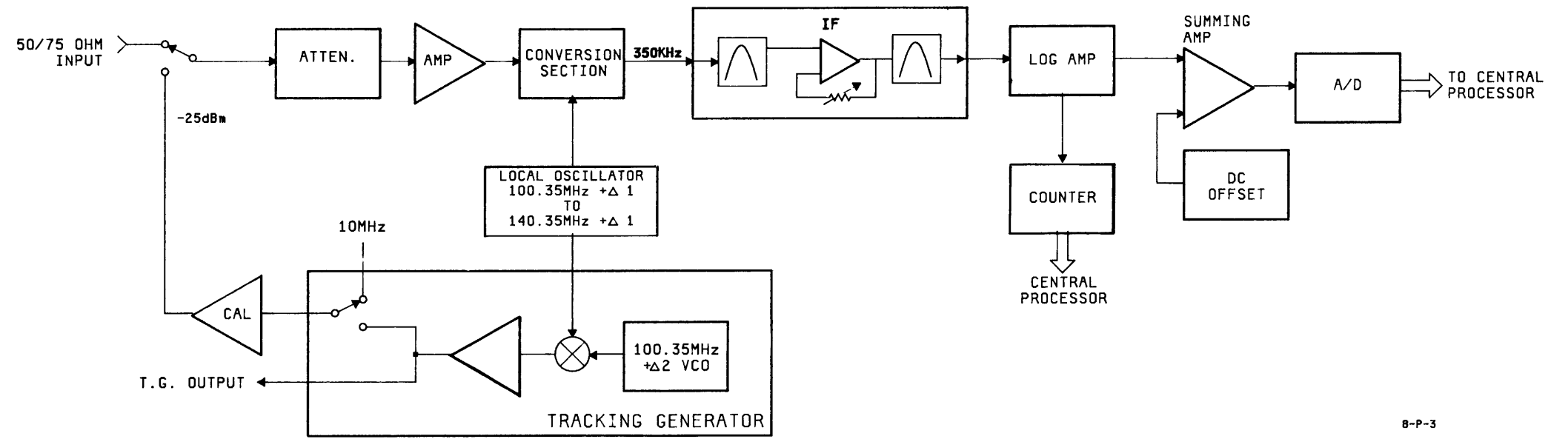


85A-8-P-2

**NOTE**

*Table 11-P-4 describes the Calibration Errors which can occur during each of the calibration steps.*

**Figure 11-P-2. Calibration Sequence Flowchart**



B-P-3

Figure 11-P-3. Calibration System Block Diagram  
11-7/11-8

**Table 11-P-4. Calibration Error Definitions**

<b>NOTE</b>	
<i>This table is only meant to be a summary reference. A more complete explanation of the Calibration Errors is given in Table 11-P-5.</i>	
<b>Cal Error No.</b>	<b>Comments</b>
	The following errors occur while adjusting the IF frequency offset of the selected Res. BW. (Step 1)
01	Measured amplitude too large
02	Measured amplitude too small
03	4dB IF gain steps in error
	The following errors occur while adjusting the Tracking Generator frequency so that it will track the input frequency $\pm 1$ Hz. This calibration is done at 5MHz and 30KHz Res BW. (Step 2)
09*	Counter malfunction
10*	Tracking Generator cannot be adjusted to track the input frequency to within $\pm 1$ Hz.
	The following errors occur while calibrating the amplitude offset of the selected Res. BW with the 10MHz Reference signal. (Step 3)
04	Measured amplitude too small
05	Measured amplitude too large
06	Measured amplitude is slightly divergent
07	Measured amplitude offset exceeds $\pm 5$ dB
08	4dB IF gain steps in error
	The following errors are the same as calibration errors 01 thru 10 except the errors occur while re-calibrating the 1kHz Res. BW. (Step 4)
11	Measured amplitude too large
12	Measured amplitude too small
13	4dB IF gain steps in error
14	Measured amplitude too small
15	Measured amplitude too large
16	Measured amplitude is slight divergent
17	Measured amplitude offset exceeds $\pm 5$ dB
18	4dB IF gain steps in error
19	Counter malfunction
20	Tracking Generator cannot be adjusted to track the input frequency to within $\pm 1$ Hz.
	The following errors occur while calibrating the amplitude offset at 10MHz with the Tracking Generator and the 1kHz Res. BW. (Step 4)
21	Measured amplitude too small
22	Measured amplitude too large
23**	Measured amplitude at 10MHz using the Tracking Generator differs by more than $\pm 1$ dB from the measured amplitude at 10MHz using the 10MHz reference.
	The following errors occur while calibrating the amplitude offset at the Manual or Center Frequency with the Tracking Generator and the 1kHz Res. BW. (Step 5)

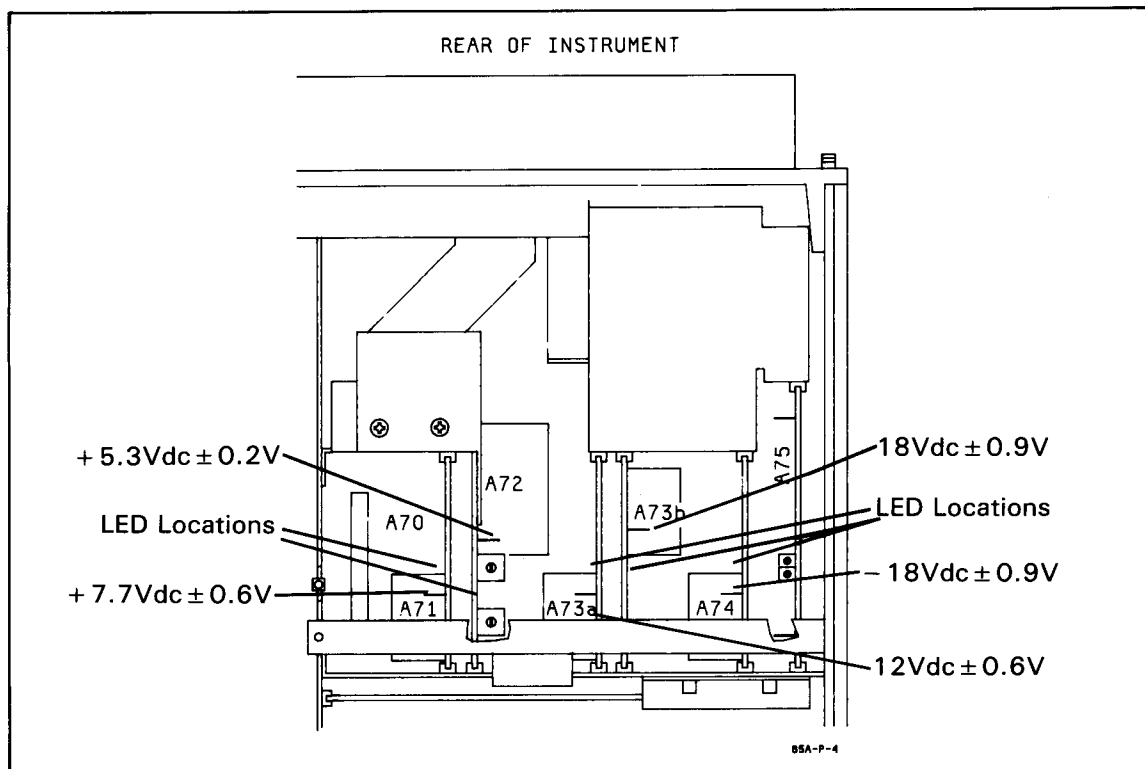
**Table 11-P-4. Calibration Error Definitions (Cont'd)**

Cal Error No.	Comments
24	Measured amplitude too small
25	Measured amplitude too large
26	Measured amplitude is slightly divergent
27	Total IF amplitude offset exceeds $\pm 5\text{dB}$
	The following errors occur while calibrating the input attenuators. (Step 6)
28	Measured amplitude too small
29	Measured amplitude too large
30**	Measured amplitude of the attenuator calibration differs from the measured amplitude of the IF calibration by more than $\pm 1\text{dB}$ .
31**	Attenuator plus IF amplitude offset exceeds $\pm 5\text{dB}$ .
33*	Tracking Generator data cable (A50J5 or A40J4) is disconnected.
<p>* When these Cal Errors are displayed the Cal routine does not abort. The 10MHz Reference is used in place of the Tracking Generator and the routine continues.</p> <p>** the Calibration routine will attempt to remove the error from the system. If successful the routine will continue. If the errors are <math>&gt; \pm 5\text{dB}</math> the routine will abort.</p>	



### 3585A PRELIMINARY TROUBLESHOOTING PROCEDURE

- A.**
1. Set the **LINE** switch to **OFF**.
  2. Remove the instrument's top cover.
  3. Set the **LINE** switch to **ON**.
- B.** Are the five green LED's on Power Supply boards A71-74 lit (Figure 11-P-4) and the yellow LED's off.
1. If the green LED's are on and the yellow LED's off then go to step C. Note that the Power Supply voltages can be incorrect even when the green LED's are on; therefore, if there is a question about one of the Power Supplies check them against those in Figure 11-P-4.
  2. If some of the green LED's are off or the yellow LED's on, go to Service Group I. If only one of the Power Supplies is faulty, go to the Service Group pertaining to that Power Supply (Service Group 11-I-2-1 thru 11-J-2-5). If two or more of the Power Supplies are faulty go to Service Group 11-I-1.



**Figure 11-P-4. Power Supply Voltage Indicators And Test Points**

**C. Does the trouble appear *only* when the High Impedance (1M $\Omega$ ) input is being used?**

1. If question C is true, then the problem is isolated to the 1M $\Omega$  input, go to Service Group A-1 and start at the A1 1M ohm Channel Troubleshooting Tree.
2. If the problem is not isolated to the 1M $\Omega$  channel, go to step D.

**D. Does the trouble appear *only* when the instrument is being operated in Remote?**

1. If yes, then go to Service Group F to troubleshoot the HP-IB board.
2. If the problem is not isolated to Remote operation, go to step E.

**E. Is the trouble associated with the rear panel VIDEO OUTPUT, DISPLAY outputs or PLOTTER outputs *only*?**

1. If the problem is with one of the rear panel outputs listed, go to:
  - Service Group A-5 for a VIDEO OUTPUT problem, probable defect is the buffer op-amp A15U8d.
  - Service Group D-3 for the DISPLAY X and Y outputs (probable defect A64U20,U21,F1,F2 or CR4-7) and Service Group D-2 for the DISPLAY Z output (probable defect A63F2,Q4,CR4, CR5 or U14).
  - Service Group H for the PLOTTER X and Y outputs and Service Group D-2 for the PLOTTER Z output (probable defect A63F1,Q2,Q3,CR2 or U18b).
2. If the problem is not related to these rear panel outputs, go to step F.

**F. Are the proper front panel keyboard LED's lit (Figure 11-P-5)?**

1. If the correct keyboard LED's are lit, then go to step G.
2. If the keyboard LED's are incorrect according to Figure 11-P-5, then go to step F-3.
3. Does the marker move when the Marker/Continuous Entry Control (knob) is rotated?
  - a. If the marker moves, go to step F-4.
  - b. If the marker will only move in one direction or not at all, then the Central Processor is not responding to keyboard inputs. Go to the Main Troubleshooting Tree for Service Group C.
4. Can some of the keys with an LED indicator be turned on and off.
  - a. If some of the keys can be turned on and off, then the problem has to do with the LED's or the LED drivers, go to Service Group C-4.

- b. If the keys will not respond, the Marker/Continuous Entry Control may be keeping the keys from responding. Start with the Knob Troubleshooting procedure, Service Group C. If the "Marker/Continuous Entry Control" checks out good, then go to the Keyboard Troubleshooting Tree, Service Group C-4.

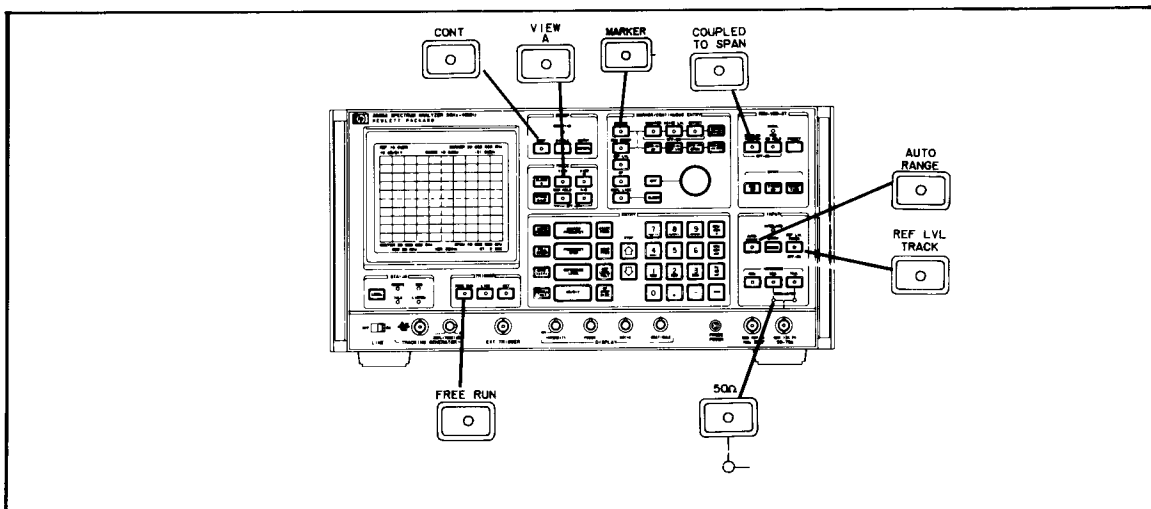
**G. Press each of the front panel keys that has an LED indicator.**

- 1. If all of the key lights operate properly, go to step H. (If *some* of the lights fail to go on or off, go to Service Group C-4.)
- 2. If *none* of the keys will respond, proceed with the flow chart associated with Figure 11-P-6, Display Test.

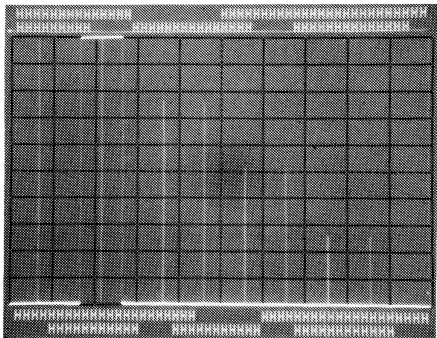
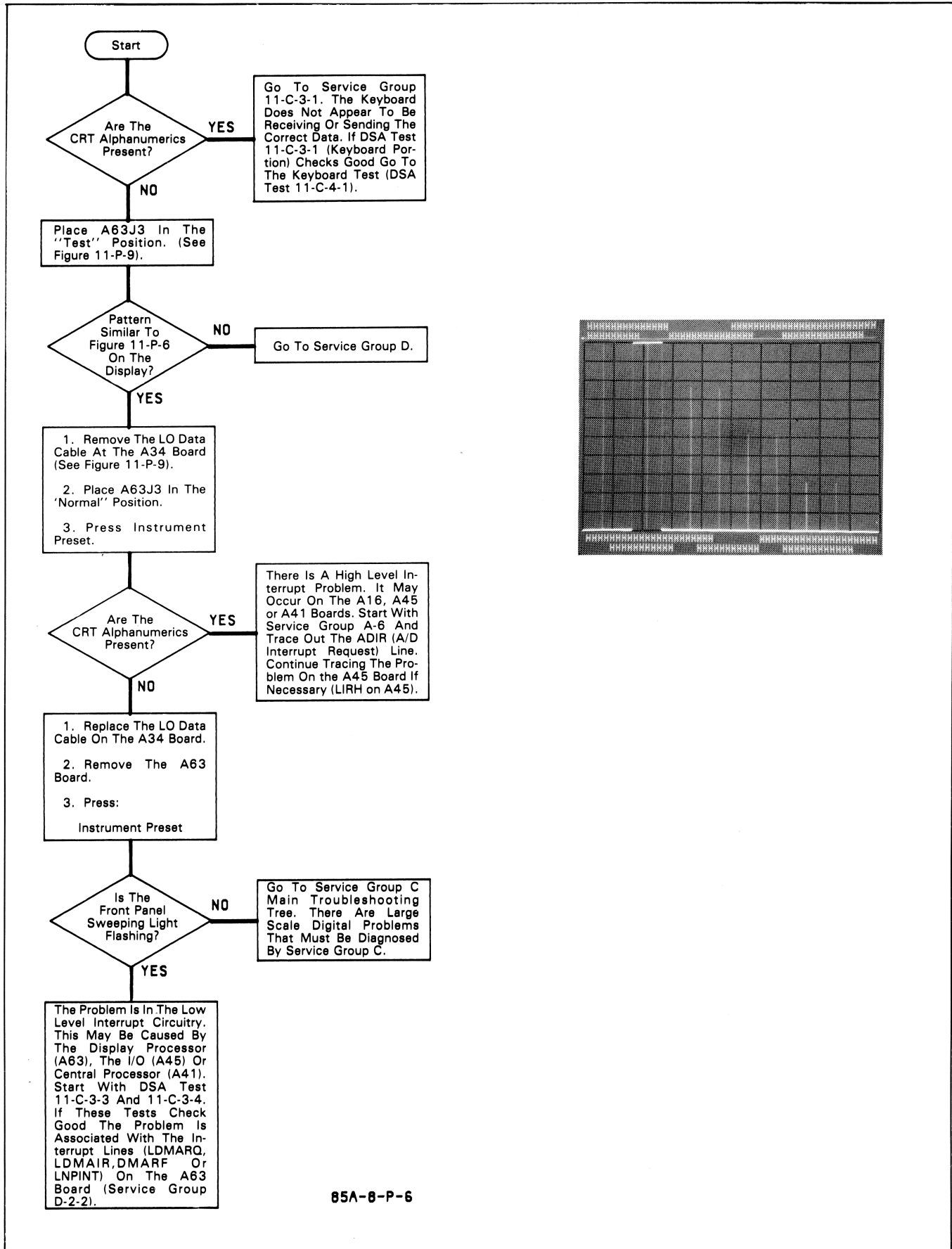
**H. Press INSTRUMENT PRESET.**

**Did the beeper sound and/or a Cal Error Code or failure message appear on the CRT screen?**

- 1. If the beeper did not sound or messages other than "Calibrating" appear on the CRT screen, go to step J.
- 2. If the beeper sounds and/or a Cal Error Code is displayed, check Table 11-P-5 for an indication of the error. If the error indicates several possible causes, continuing with step J should help narrow down the problem.



**Figure 11-P-5. Front Panel LED Turn-on State**



65A-8-P-6

Figure 11-P-6. Display Test Pattern

**Table 11-P-5. Calibration Error Action Table**

Symptom	Action - Go To Specified Service Group
No display, beeper sounds	Service Group C - ROM Checksum error.
Display visible, beeper sounds, no Cal errors.	Service Group C - ROM Checksum error.
Local Osc. Unlocked	Service Group B
Counter Failure	Service Group G
Cal Error 1,2,4,5 or 7	Go to step 1 of this procedure.
Cal Error 3 or 8	The defect may be in the IF Gain Amplifiers (A12), the dc offset (A15) or the A to D Converter (A16). Run the A to D Converter Check at the end of this table. If the A to D Converter Check looks OK, go to Service Group A-3.
Cal Error 11 thru 18	Service Group A-3 - 1KHz IF Bandwidth error.
Cal Error 6 or 16	The defect may be in the Log Linearity (A14), the dc offset (A15), the A to D Converter (A16) or the IF Gain Amplifiers (A15). Run the A to D converter Check at the end of this Table. If the A to D Converter Check looks OK, go to Service Group A-4, then Service Group A-3, then Service Group A-5.
Cal Error 9 or 19 or Counter Failure	Service Group G - The Counter is not working properly or the buffer formed by A14Q3 or A61U1a is defective.
Cal Error 10 or 20	<p>Enter:</p> <p style="padding-left: 40px;">Res. BW                    1kHz</p> <p style="padding-left: 40px;">Recall 4</p> <p>Note the Cal Error:</p> <ol style="list-style-type: none"> <li>1. If you had a Cal Error 20 originally and now have a Cal Error 10, the 1kHz Res. BW is in error. Go to Service Group A-3.</li> <li>2. If you had a Cal Error 10 in both cases the tuning information for the Tracking Generator DAC may be in error. Go to Service Group E.</li> <li>3. If the Cal Error went away in the 1KHz BW the 30kHz Res. BW center frequency is in error. Adjust A5T3,4 and A14L5,7 according to the directions given in Section V.</li> </ol>
Cal Error 21 thru 23	Service Group E - The Tracking Generator or Cal Signal Switching circuit is in error.
Cal Error 24 thru 27	<ol style="list-style-type: none"> <li>1. Connect the Tracking Generator Output to the Terminated (50Ω) input. Is the trace flat <math>\pm 1</math>dB?</li> </ol>

**Table 11-P-5. Calibration Error Action Table (Cont'd)**

Symptom	Action - Go To Specified Service Group
Cal Error 24 thru 27 (Cont'd)	<p>a. If the trace is flat <math>\pm 1</math> dB, go to Service Group A-1 and Troubleshooting the Calibrator.</p> <p>b. If the trace is not flat <math>\pm 1</math> dB, go to step 2.</p> <p>2. Disconnect the Tracking Generator. Connect a source of known accuracy to the Terminated Input. Set the source for an Amplitude of <math>-25</math> dBm. Set the source frequency to 10,20,30 and 40MHz. Note the amplitude shown by the 3585 for each frequency setting.</p> <p>a. If the amplitude readings are within <math>\pm 1</math> dB of <math>-25</math> dBm, go to Service Group E.</p> <p>b. If the amplitude readings are not within <math>\pm 1</math> dB, go to Service Group A-1.</p>
Cal Error 28 thru 30	<p>Service Group A-1 - These errors are almost invariably caused by the Terminated channel attenuators; however, they can be caused by the 16dB amplifiers, the 4dB step attenuator or the Overdrive attenuator on the A12 and A13 boards (Service Group A-3).</p>
Cal Error 31	<p>Service Group A-3 - This error can be caused by IF Gain step errors, slightly resistive attenuators in the Terminated channel (Service Group A-1) or Log Linearity problems (Service Group A-4).</p>
Cal Error 33	<p>The Tracking Generator has been removed from the instrument or the cable from A50J2 to A40J4 has been disconnected.</p>

**A/D Converter Check**

1. Enter:

```

RECALL 603
INSTRUMENT PRESET
START FREQUENCY.....9,999,980Hz
STOP FREQUENCY.....10MHz
SWEEP TIME.....18 sec
    
```

2. The display should now resemble Figure 11-P-7. Do not be concerned if vertical displacement is apparent, this may be caused by IF gain problems.

3. Is the trace smooth with no apparent "stair steps". (See Figure 11-P-8).

4. If the trace is smooth the A to D Converter is operating correctly.

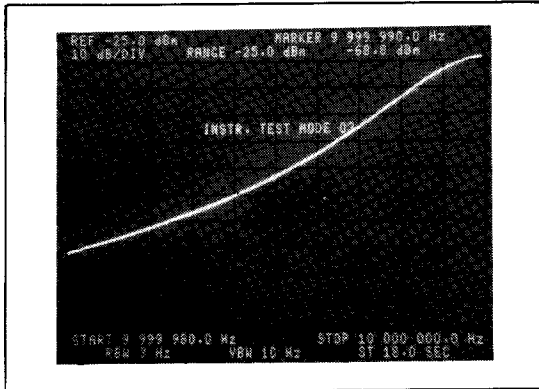


Figure 11-P-7. Correct A/D

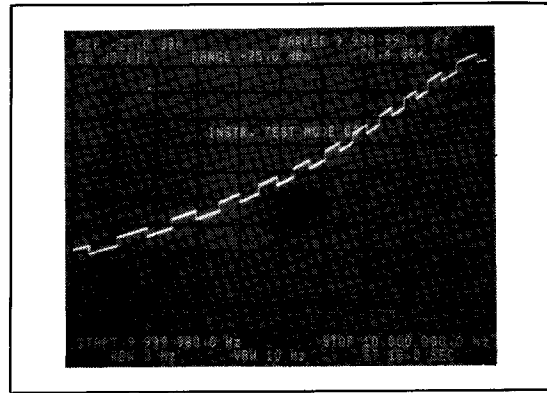


Figure 11-P-8. Faulty A/D Converter Response

- I. **A main signal path problem has occurred. Use the flow chart in Figure 11-P-9 to help isolate the problem to one or more boards.**
  
- J. **Is the front panel SWEEPING light flashing?**
  1. If it is flashing, go to step K.
  2. If it is not flashing, go to Service Group B-5.
  
- K. **Are the CRT *alphanumeric* readouts present and correct as shown in Figure 11-P-10? (At this point, ignore the graphic presentation and the numeric value of the "MARKER" amplitude reading.)**
  1. If the alphanumeric readouts are correct, go to step L.
  2. If the alphanumeric readouts are not correct, place A63J3 in the "Test" position (see Figure 11-P-11).
    - a. If the CRT display now resembles Figure 11-P-11, then the information being sent by the Central Processor to the Display Processor is incorrect. Go to Service Group C to troubleshoot the problem. Note that A63U28, U41 and U42 (Service Group D-2-3) can also cause this problem.
    - b. If the CRT display does not resemble Figure 11-P-11 (i.e., display is distorted, blank, etc.), then the problem is in the Display Section (Service Group D).

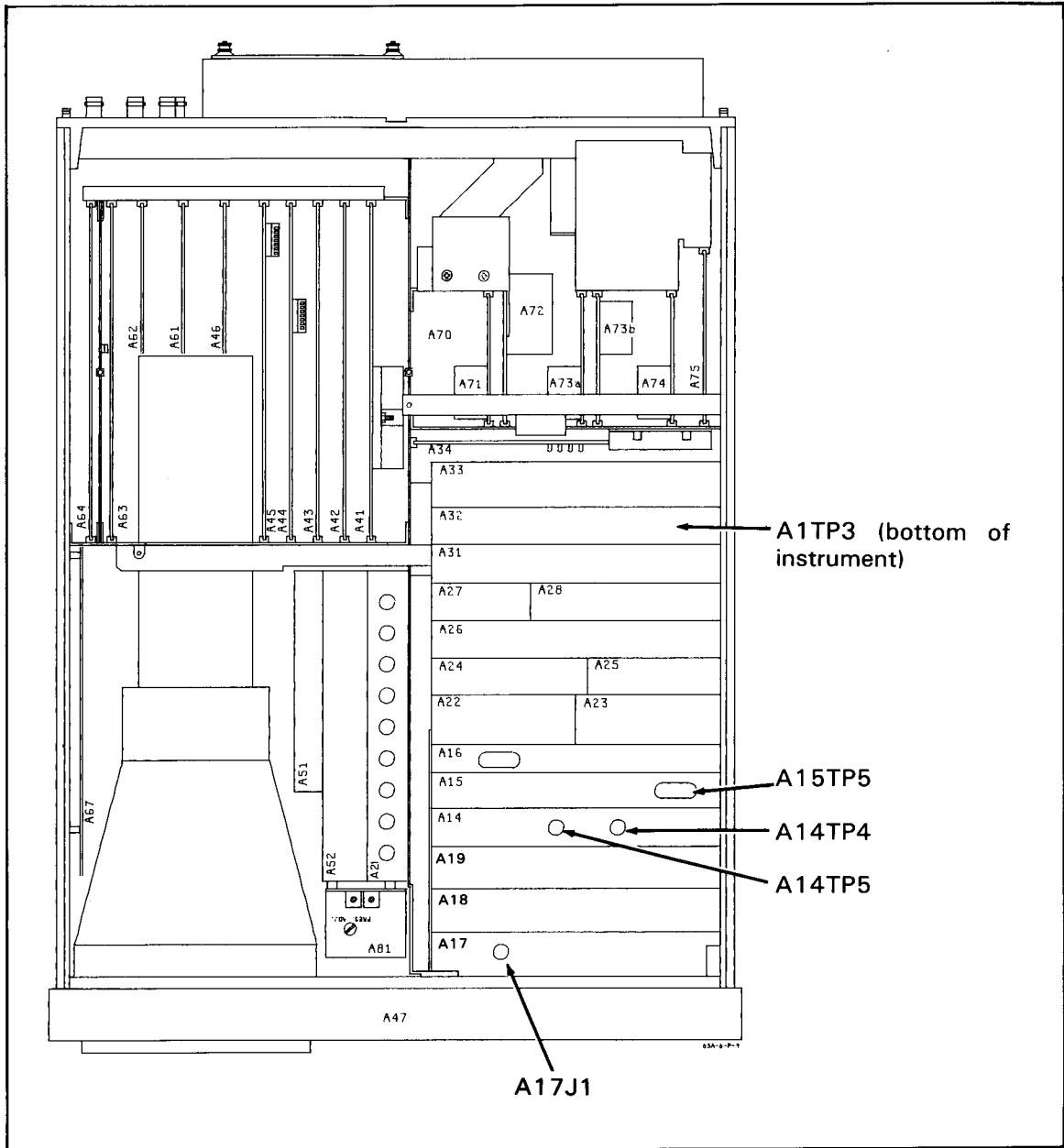
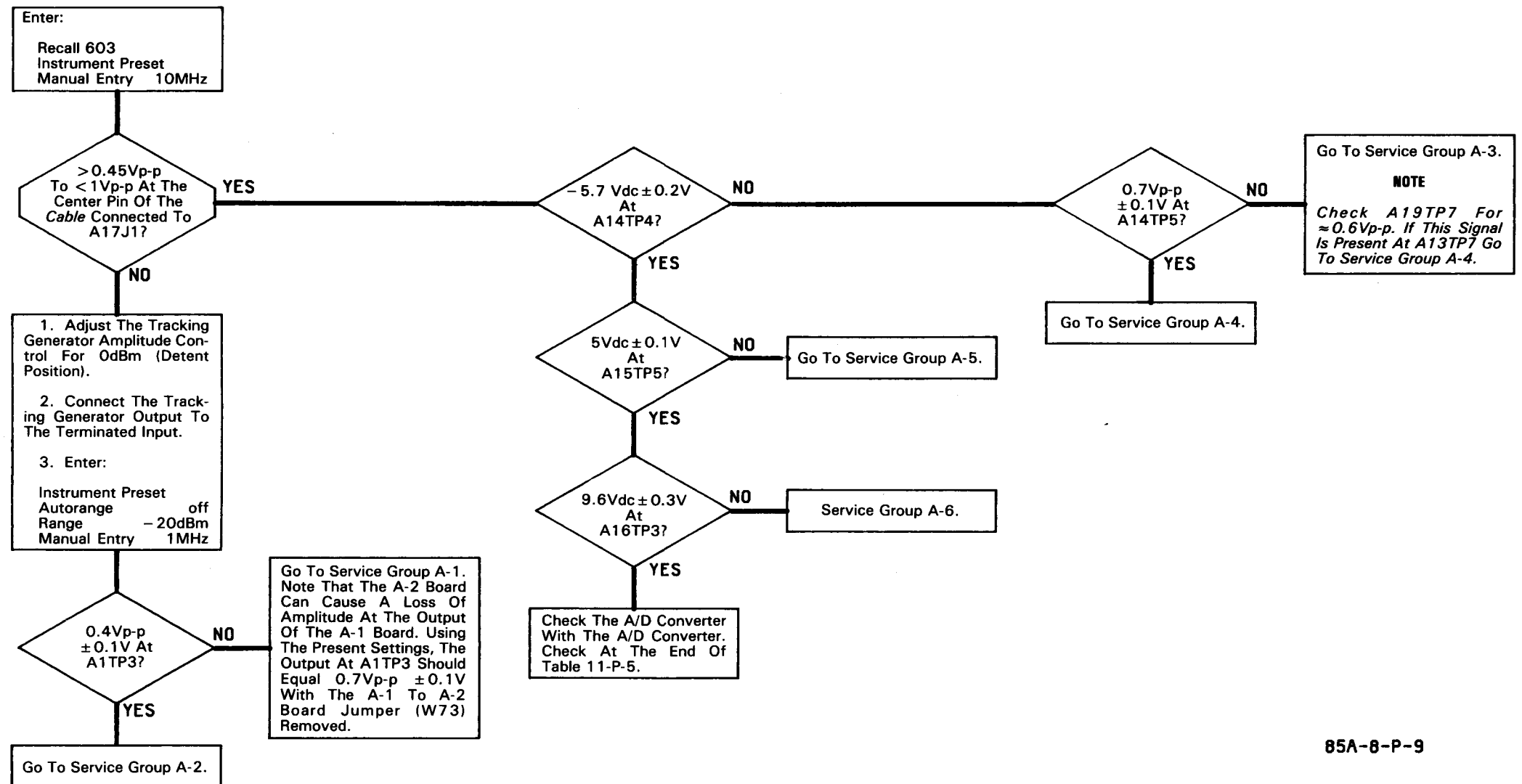


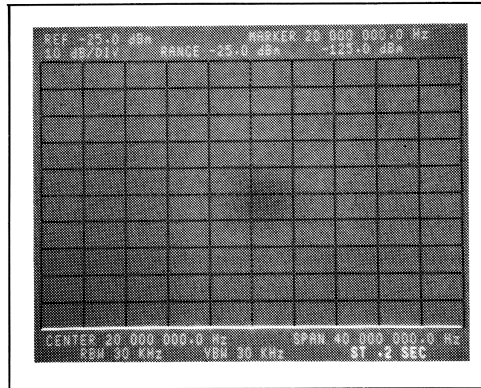
Figure 11-P-9a. Main Signal Path Test Point Locations



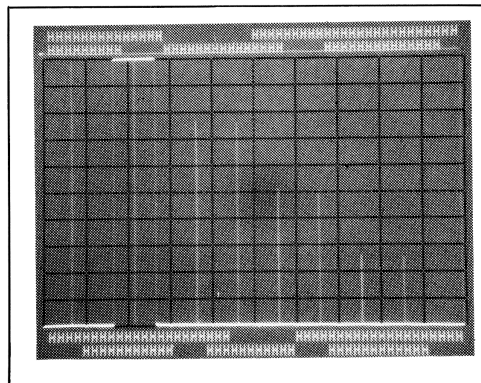


85A-8-P-9

Figure 11-P-9b. Main Signal Path Troubleshooting Tree  
11-19/11-20



**Figure 11-P-10. Correct Alphanumeric Display**



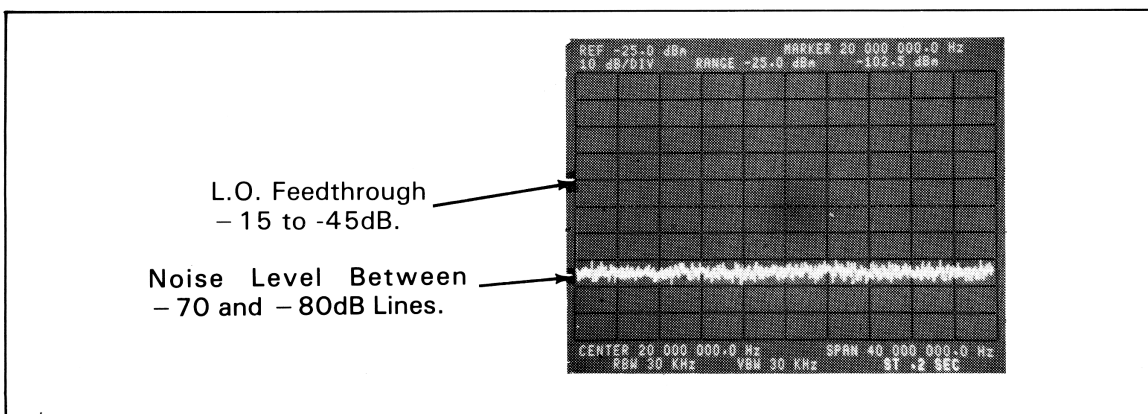
**Figure 11-P-11. CRT Test Pattern**

- L. Do the front panel DISPLAY controls (i.e., INTENSITY, FOCUS, etc.) operate properly?**
1. If the controls operate properly, go to step M.
  2. If the controls fail to have an effect on the display, go to Service Group D-4.
- M. Check the graphic presentation (see Figure 11-P-12):**
1. **Is the noise floor present and is the average noise level – 70dB to – 80dB below the Reference Level (top graticule line)?**
    - a. If the noise floor is within the specified range, continue with step M-2.
    - b. If the noise floor is not within the specified range, then go to step I.
    - c. If there is no graphic display at all (including the line across the bottom of the display graticule), go to Service Group D.
  2. **Is the analyzer's zero response present and is its peak amplitude – 15dB to – 45dB below the Reference Level?**

**NOTE**

*If the zero response is not visible, increase the display intensity -the zero response is sometimes difficult to see because it is masked by the CRT graticule.*

- a. If the zero response is between -15dB and -45dB below the Reference Level, go to step N.
- b. If the zero response is greater than 45dB below the Reference Level there is a problem in the Input/Conversion Section. This may be due to the Local Oscillator, the Conversion Section circuitry or dc offset from the A1 Output Buffer. Service Group A-2 will allow you to check the Local Oscillator and Conversion sections. If these two sections check good, go to Service Group A-1 and check the Output Buffer. If the zero response is less than 15dB below the Reference Level there is a dc offset problem in the A1 Output Buffer, Service Group A-1.



**Figure 11-P-12. Correct Graphic Display**

**N. Press:**

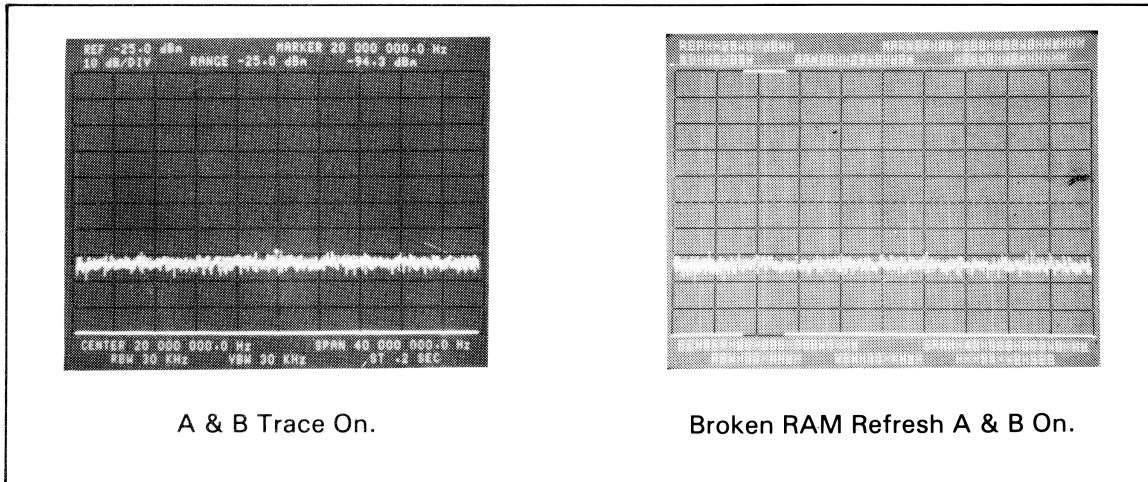
INSTRUMENT PRESET  
VIEW B.....on

**Do the alphanumeric readouts on the CRT appear to be correct? (See Figure 11-P-13.)**

- 1. If the alphanumerics appear correct, go to step O.
- 2. If the alphanumerics look as though one set of words is being written over another (see Figure 11-P-13) the RAM Refresh circuitry is not functioning correctly. Go to Service Group C, DSA Test 11-C-2-2.

**O. Press each of the dark brown ENTRY keys and verify that the corresponding parameter is properly displayed and highlighted on the CRT screen.**

- 1. If each of the ENTRY keys highlights the proper parameter, continue with step P.
- 2. If some of the Entry keys fail to highlight the proper parameter, go to Service Group C-4.



**Figure 11-P-13. RAM Refresh Test**



**P. To verify that the remaining front panel keys are operative, enter:**

- RECALL.....ENTER OFFSET
- RECALL.....MKR ← CF
- RECALL.....MKR ← REF LVL
- RECALL.....OFS ← SPAN
- RECALL.....MKR-OFS ← STEP
- RECALL.....OFF
- RECALL.....CLEAR
- RECALL.....PRESET
- RECALL.....LOCAL

**The beeper should sound after each entry.**

1. If the beeper beeped after each entry, go to step Q.
2. If the beeper failed to sound after one or more of the above entries the Keyboard is not being read correctly, go to Service Group 11-C-4.


**Q. Activate REF LVL: (Marker/Continuous Entry block)**

1. Does the Reference Level readout increase when the  is rotated clockwise?
2. Does the Reference Level readout decrease when the  is rotated counter clockwise?
  - a. If the Reference Level readout changes correctly according to the above instructions, go to step R.
  - b. If the Reference Level will not move or will only move in one direction, go to Service Group C-4 and use the Front Panel Knob Troubleshooting Procedure.

**R. Press INSTR PRESET.**

**Narrow the Res BW to 3kHz. Is the “LOCAL OSC. UNLOCKED” message displayed on the CRT screen?**

1. If there is no LOCAL OSC. UNLOCKED message displayed, go to step S.
2. If the LOCAL OSC. UNLOCKED message is displayed, go to Service Group B.

**S. Decrease the Sweep Time one step with SWEEP TIME  . Is the front panel UNCAL indicator lighted?**

1. If the UNCAL light is on, go to step T.
2. If the UNCAL light is off, the LED or the LED driver is faulty. Go to Service Group C-4.

**T. Enter:**

INSTRUMENT PRESET  
COUNTER ..... on

**Connect the 3585 rear panel 10MHz REF OUTPUT to the 50Ω front panel input. Allow time for the instrument to Autorange. Does the COUNTER reading (upper right of the CRT) equal 20MHz ± 0.3Hz (see Figure 11-P-14)?**

1. If the Counter reading is correct, go to step U.
2. If the Counter reading is incorrect, set the 3585 for:

MANUAL ENTRY ..... 20MHz

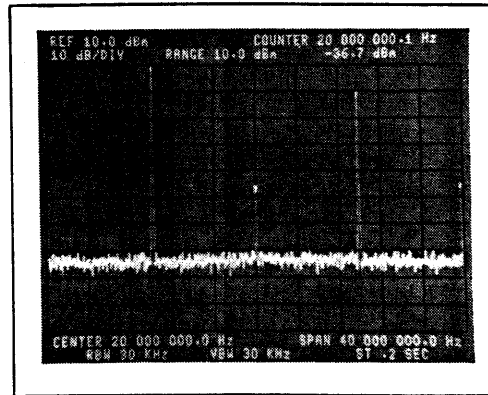
Connect a Counter to the front panel Tracking Generator Output and Frequency lock it to the 10MHz REF OUTPUT. If the Counter reads 20MHz ± 2Hz then the problem is in the Counter (Service Group G). If the Counter does not read within this range, the Local Oscillator is not outputting the correct frequency, go to Service Group B.

**U. Set the 3585A controls as follows:**

Press PRESET to reoptimize the Sweep Time Coupling.  
STOP FREQUENCY ..... 40.1MHz  
MANUAL FREQUENCY ..... 20Hz  
RES. BW ..... 30kHz

**V. Does the 3585A calibrate properly on each Res. BW setting (30kHz to 3Hz) with no calibration errors?**

1. If the 3585 calibrates properly in all Res. Bandwidths, go to step W.



**Figure 11-P-14. Counter Test**

2. If calibration errors occur on some Bandwidths do the following:
  - Connect the Tracking Generator Output to the Terminated input.
  - Enter:
    - PRESET (RBW-VBW-ST)
    - MANUAL SWEEP
    - OFFSET ..... on
    - ENTER OFFSET
    - COUNTER ..... on
  - a. If the OFS COUNTER reading is  $\leq \pm 1\text{Hz}$ , the problem is in the IF section (Service Group A-3).
  - b. If the OFS COUNTER reading is  $> \pm 1\text{Hz}$  the problem is in the Tracking Generator (Service Group E).

**NOTE**

*If the LOCAL OSC. UNLOCKED message occurs during this test, the A27 board may be out of adjustment.*

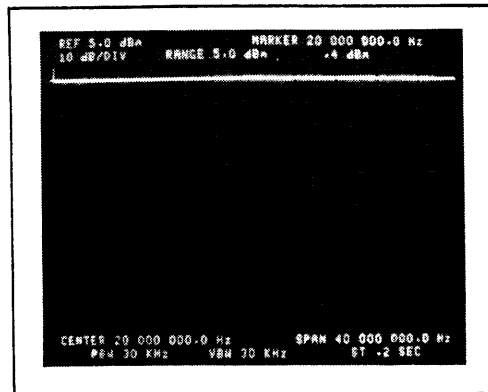
**W. Enter a Manual frequency of 40.098765MHz; leave RBW set to 3Hz. Does the 3585A calibrate properly?**

1. If the 3585 Calibrates properly, go to step X.
2. If the 3585 does not Calibrate properly, a Frequency Response problem exists on the Input board (Service Group A-1). The frequency response problem may be related to the Calibrator, Terminated Channel Attenuators, 11dB Gain Amp or the 40MHz Low Bass Filter.

**X. Set the RBW to 30kHz. Rotate the Tracking Generator AMPLITUDE control fully clockwise (0dBm). Connect the Tracking Generator output to the front panel Terminated (50Ω) input. Did the 3585A automatically uprange to 0dBm (see Figure 11-P-15)?**

1. If the instrument upranged properly, go to step Y.
2. If the instrument did not uprange check the "Terminated" LED (below the

50Ω key), is it lit. If the Terminated LED is lit, the problem is in the Autorange circuit (Service Group A-1). If the Terminated LED is not lit the problem is in the Protection Circuit (Service Group A-1).



**Figure 11-P-15. Correctly Autoranged Displayed**

**Y. Is the Marker amplitude reading 0dBm ± 0.8dB?**

1. If the Marker reads 0dBm ± 0.8dB, go to step Z.
2. If the Marker reading is outside of the listed tolerance the A16 board Sample and Hold circuitry or the Tracking Generator Flatness may be causing the problem. If the output is consistently low over the frequency range, or the amplitude increases by >0.5dB when placed in Manual Sweep, go to Service Group A-6 (A/D Converter). To check the Tracking Generator Flatness Enter:

```

RECALL 604
INSTRUMENT PRESET
RANGE ..... - 25dBm
REFERENCE LEVEL..... - 20dBm
dB/DIV ..... 1dB
    
```

If the displayed trace is flat (- 25dBm ± 0.5dB) then the problem is in the Tracking Generator, Service Group E. If the trace flatness is out of tolerance, either the Calibrator or the 41MHz Filter (Service Group A-1) is in error. Use a source of known amplitude with the 3585 in Test Mode 1 (Recall 601, Instrument Preset). If the amplitude accuracy checks out good with an external source, the Calibrator is probably at fault.

**Z. Decrement the RANGE to -5dBm (one step). Is the front panel OVERLOAD light on?**



1. If the OVERLOAD light is on, go to step AA.
2. If the OVERLOAD light is off the Autorange circuit is not operating correctly (Service Group A-1).

- AA. **Reset the RANGE to 0dBm**  
**Activate OFFSET; press ENTER OFFSET**  
**Activate COUNTER**  
**Force a calibration by entering RECALL 4.**
  
- BB. **Step the Res. BW from 30 kHz to 3Hz. On each Res. BW setting, allow time for the instrument to automatically calibrate. Then verify that the "OFS CNTR" frequency is 0Hz ± 1Hz, and the amplitude reading is 0dB ± 0.5dB (except 3Hz Res. BW = 0dB ± 2dB).**
  - 1. If the OFS CNTR and Marker readings are within the specified limits, go to step CC.
  - 2. If the OFS CNTR or Marker reading is out of the specified limits the problem is in the IF section (Service Group A-3) or the Tracking Generator D/A Converter (Service Group E).
  
- CC. **Enter REFERENCE LEVEL     dBV**  
**Press ENTER OFFSET**  
**Set the IMPEDANCE to 75Ω. Is the amplitude reading + 1.6dB ± 0.2dB?**
  - 1. If the amplitude reading is correct, go to step DD.
  - 2. If the amplitude reading is incorrect, the probable defect is the Impedance selection relay, A1K4 (Service Group A-1).
  
- DD. **Enter: RECALL 6 0 3; then press INSTR PRESET (Instrument Test Mode 03).**  
**Set the 3585A controls as follows:**

```

RANGE ..... + 30dBm
REFERENCE LEVEL..... + 40dBm
CENTER FREQUENCY.....10MHz
FREQUENCY SPAN.....0Hz
RES. BW.....100Hz
VBW.....1Hz
SWEEP TIME.....20 seconds
SWEEP.....SINGLE
MARKER/CONTINUOUS ENTRY.....REF LVL
    
```

**Clear the trace and reset the sweep by pressing CLEAR A.**

- EE. **Start the sweep by pressing SINGLE.**  
**Rotate  slowly and smoothly in a counterclockwise direction to produce a linear ramp response similar to the one shown in Figure 11-P-16. If there are any significant discontinuities, cusps or "glitches" in the ramp, rotate  clockwise until the beeper sounds, clear the trace by pressing CLEAR A and then repeat the test. Reappearance of the discontinuity indicates trouble in the IF gain switching (Service Group A-3) or video offset circuitry (Service Group A-5).**



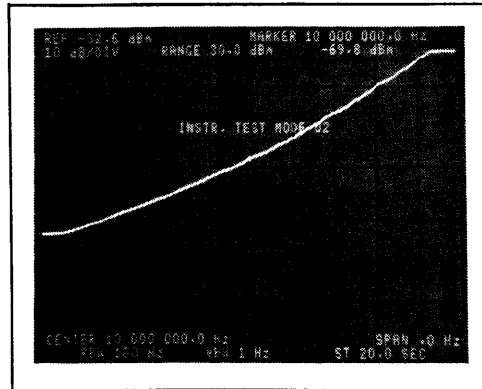




Figure 11-P-16. IF Gain Test Display

- FF.** Rotate  clockwise until the beeper sounds.  
 Set the Center Frequency to 20MHz and the Sweep Time to 30 seconds.  
 Clear the trace by pressing CLEAR A.  
 Start the sweep by pressing SINGLE.  
 Rapidly and smoothly rotate  counterclockwise until the beeper sounds and then clockwise until the beeper sounds. Repeat until the end of the sweep to produce several ramp like responses as shown in Figure 11-P-17. Discontinuities or cusps that appear at the same points on each of the responses, or the inability to obtain full-scale deflection indicates trouble in the IF gain switching (Service Group A-3) or video offset circuitry (Service Group A-5).

**NOTE**

*Ignore the glitches that appear at the positive and negative extremities of the responses.*

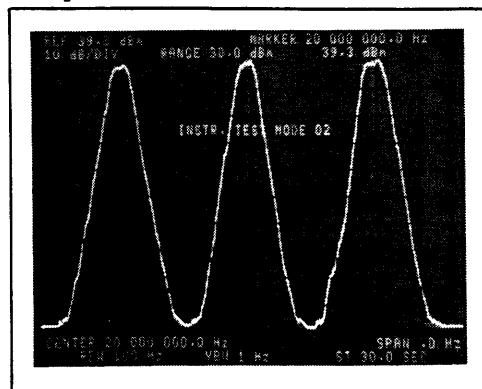



Figure 11-P-17. IF Gain Test For FF

- GG.** Press INSTR PRESET.  
 Set the RANGE and Reference Level to 0dBm (Auto. Range OFF).  
 Rotate the Tracking Generator AMPLITUDE control fully clockwise (0dBm).  
 Connect the Tracking Generator output to the 50-ohm Terminated input.

Adjust the Reference Level with REF LVL  so that the Tracking Generator's response (at the Marker) is just below the top graticule line.

Press MKR → REF LVL.

Increment the Reference Level 5dB (one step) with REF LVL .

Store the trace in "B" by pressing STORE A → B.

Deactivate VIEW B; Activate A-B (see Figure 11-P-18).

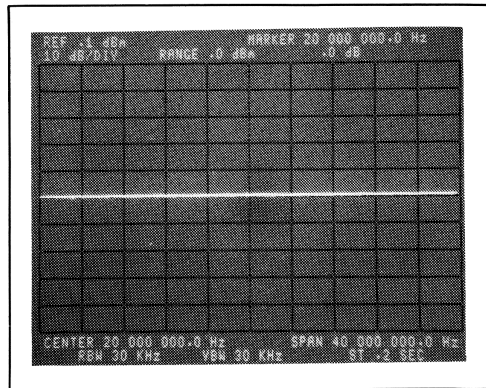



Figure 11-P-18. dB/Div Amplifier Test Set-Up

HH. With dB/DIV , decrement the Vertical Scale and verify that the Marker amplitude reading is within the following limits:

dB/DIV	Reading
5dB	- 2.5dB ± 0.2dB
2dB	- 4.0dB ± 0.2dB
1dB	- 4.5dB ± 0.2dB

1. If the Marker Amplitude readings are correct, go to step II.
2. If the Marker Amplitude readings are in error the problem is associated with the dB/DIV amplifier on the A15 board (Service Group A-5).


II. Disconnect the Tracking Generator from the Terminated input.

Press INSTR PRESET.

Set the Start Frequency to 1MHz.

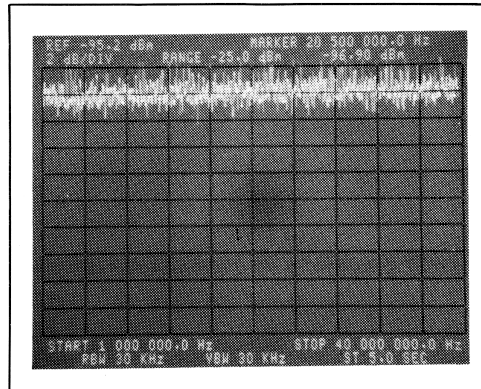
Set the Sweep Time to 5 seconds.

Deactivate COUPLED TO SPAN.

JJ. Adjust the Reference Level with REF LVL  so that the noise is in the top vertical division of the CRT graticule.

Set the Vertical Scale to 2dB/DIV.

Adjust the Reference Level so that the noise is approximately centered on the line below the Reference Level (see Figure 11-P-19).



**Figure 11-P-19. Video Filter Test Set-Up, Upper Six VBW's**

**KK.** Step the VBW from 30kHz to 100Hz and observe the changes in the noise level. Normal indications are as follows:

VBW	Noise Level
10kHz	decreases by about one division
3kHz	decreases by about 1.5 divisions
1kHz	decreases by about 1 division
300Hz	decreases by about 0.5 division
100Hz	decreases by about 0.4 division

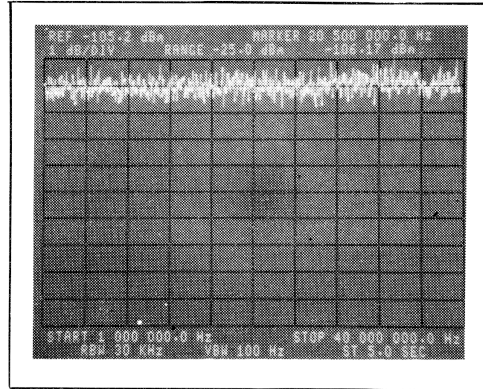
1. If the noise level decreases in the specified manner, go to step LL.
2. If the noise level does not decrease or decreases too much at some settings the problem is in the Video Filter switching (Service Group A-5).

**LL.** Move the noise to the top of the screen by adjusting the Reference Level. Narrow the Vertical Scale to 1dB/DIV. Set the Sweep Time to 10 seconds. Adjust the Reference Level so that the noise is approximately centered on the line below the Reference Level (see Figure 11-P-20).

**MM.** Step the VBW from 100Hz to 1Hz and observe the changes in the noise level. Normal indications are as follows:

VBW	Noise Level
30Hz	decreases by about 0.5 division
10Hz	does not decrease significantly, but appears smoother
3Hz	decreases by about 0.25 division and appears smoother
1Hz	does not decrease significantly, but appears smoother

1. If the noise level decreases in the specified manner, go to step NN.
2. If the noise level does not change in the expected manner the problem is in the Video Filter switching (Service Group A-5).



**Figure 11-P-20. Video Filter Test Set-Up, Lower Four VBW's**

- NN. Press INSTR PRESET. Activate the LINE Trigger function. Is the SWEEPING light flashing?**
  1. If the SWEEPING light is flashing, go to step OO.
  2. If the SWEEPING light is not flashing, go to the Line and External Trigger Troubleshooting portion of Service Group B-5.
- OO. Activate the EXT Trigger function. Is the SWEEPING light off?**
  1. If the SWEEPING light is off, go to step PP.
  2. If the SWEEPING light is flashing, go to the Line and External Trigger Troubleshooting portion of Service Group B-5.
- PP. Does the SWEEPING light flash each time a short is placed across the EXT TRIGGER connector?**
  1. If the SWEEPING light will flash, go to step QQ.
  2. If the SWEEPING light will not flash when a short is applied, go to the Line and External Trigger Troubleshooting portion of Service Group B-5.
- QQ. Connect a 1MHz, 0dBm signal of known amplitude accuracy to the 3585A 50Ω input. Be sure that the source is frequency locked to the 3585A's 10MHz REF OUTPUT connector.**

**ENTER:**

```

INSTRUMENT PRESET
MANUAL ENTRY.....10MHz
MKR → CF
RANGE ..... 0dBm
AUTORANGE.....off
    
```

**This test checks the absolute amplitude accuracy of the instrument. The marker readout should be equal to 0dBm ± 0.4dB (this assumes that the sources output amplitude is exactly 0dBm).**

1. If the amplitude measured is within tolerance, go to step RR.
2. If the measured amplitude is out of tolerance either the instrument needs adjustment or the Calibrator (Service Group A-1) is not working properly.

**RR. Set the 3585A for:**

```
RES. BW.....10Hz
VIDEO BW.....1Hz
OFFSET.....on
ENTER OFFSET
```

**Decrement the source's amplitude in 5dB steps from 0dBm to -75dBm. Observe the Marker amplitude reading. It should follow the source's amplitude setting ± the tolerances shown below. (Use a source which has a very accurate attenuator or use a calibrated external attenuator to attenuate your source's output.)**

Source Amplitude (referred to Reference Level)

0dB	- 20dB	- 50dB	- 80dB
± 0.3dB	± 0.6dB	± 1.0dB	

1. If the readings are within the specified tolerance, go to step SS.
  2. If the readings are not within the specified tolerance the problem lies within the Log Amplifier circuitry. Minor problems can be remedied by adjustment of the Log Amp Linearity, larger problems should be addressed with Service Group A-4.
- SS. If the instrument has checked good to this point and your problem is specifically related to Distortion or Spurious Responses, go to Service Group J. Otherwise, your instrument is basically working correctly. Specific problems should be checked with the individual Service Groups.**

**SERVICE GROUP A****RF/IF****Board Numbers A1-A16**

<b>INDEX:</b>	<b>Service Group No.</b>	<b>Page No.</b>
Input Section (A1) Troubleshooting	A-1	11-35/11-36
Conversion Section (A2-5) Troubleshooting	A-2	11-75/11-76
Final IF Section (A11-13) Troubleshooting	A-3	11-81
Log Amplifier (A14) Troubleshooting	A-4	11-119/11-120
Video Filter (A15) Troubleshooting	A-4	11-123
Analog-to-Digital Converter (A16) Troubleshooting	A-6	11-135/11-136

**EQUIPMENT REQUIRED:**

<b>Instrument</b>	<b>Required Characteristics</b>	<b>Recommended Model No.</b>	<b>Service Group Usage</b>
Digital Multimeter	4½ digits dc Accuracy $\pm 0.05\% \pm 3$ digits ohms Accuracy $\pm 0.08\% \pm 2$ digits	-hp- 3466A	A-1,2,3,5,6
Oscilloscope	Bandwidth - dc to 100MHz Vertical Sensitivity 0.005V/Div	-hp- 1740	A-1,3,4,6
dc Power Supply	Regulated, variable $\pm 15V$ output voltage/ current monitor $\approx 200mA$ current limit	-hp- 6216A	A-1
Spectrum Analyzer	Frequency - 0.1 to 500MHz Amplitude Accuracy - $\pm 3dB$	-hp- 8558B	A-1
Frequency Synthesizer	Frequency 200Hz to 40MHz Amplitude Accuracy $\pm 0.25dB$ into 50 $\Omega$	-hp- 3335A	A-1,2,3,4
Resistor Probe	20:1 resistive divider 1k $\Omega$ input resistance	-hp- 10020A	A-2
Digital Signature Analyzer		-hp- 5004A	A-3,5
Divider Probe	Divider ration 1:1 shunt Capacitance $\leq 40$ pt	-hp- 10007B	A1,3,4,6
Resistor	20k $\Omega \pm 1\%$ , 1/8 W	-hp- P/N 0757-0449	A-5,6
Resistor	1k $\Omega \pm 1\%$ , 1/8 W	-hp- P/N 0757-0280	A-6

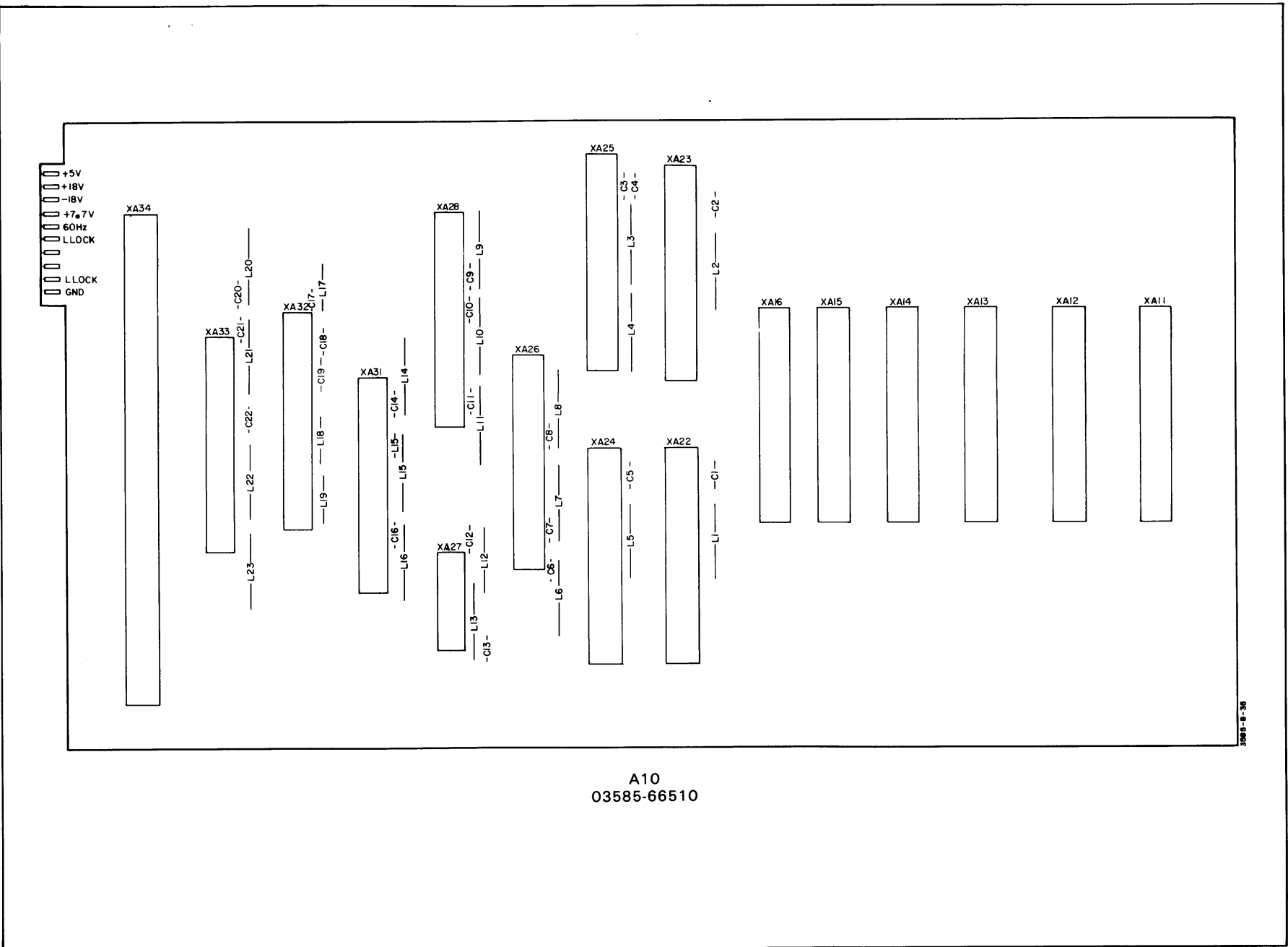


Figure 11-A-1. A10 Mother Board

# SERVICE GROUP A-1

## INPUT SECTION

**Board No. A1**  
**Part Number 03585-66501**

### INDEX:

**Page**

Input/Conversion Section Removal.....	11-37/11-38
Input Section (A1) Troubleshooting Tree.....	11-39/11-40
A1 Power Supply Troubleshooting Tree.....	11-41/11-42
A1 Terminated Input Attenuator Troubleshooting Tree.....	11-43/11-44
A1 Frequency Response Troubleshooting Tree.....	11-45/11-46
A1 Main Signal Path Troubleshooting Tree.....	11-47/11-48
A1 Calibrator Troubleshooting Tree.....	11-49/11-50
A1 1M Ohm Channel Troubleshooting Tree.....	11-51/11-52
A1 Protection Circuit Troubleshooting Tree.....	11-53/11-54
A1 Autorange Troubleshooting Tree.....	11-55/11-56
A1 11dB Gain Amp Troubleshooting Tree.....	11-57/11-58
A1 1M Ohm Buffer Troubleshooting Tree.....	11-59/11-60
A1 Output Buffer Troubleshooting Tree.....	11-61/11-62
A1 I/O, Logic And Relay Drive Troubleshooting Trees.....	11-63/11-64

### ADJUSTMENTS:

Component	Adjusted Parameter	Paragraph Location
A1R110	Bias for 11dB Gain Amp	5-45
A1R52	Calibrator Output Symmetry	5-36
A1R131	41MHz Filter Flatness	5-36
A1C83	41MHz Filter Flatness	5-36
A1L18	41MHz Filter Flatness	5-36
A1C86	41MHz Filter Flatness	5-36
A1L19	41MHz Filter Flatness	5-36
A1C89	41MHz Filter Flatness	5-36
A1L21	41MHz Filter Flatness	5-36
A1C92	41MHz Filter Flatness	5-36
A1R173	Autorange Range Up Threshold	5-37
A1R174	Autorange Range Down Threshold	5-38
A1R39	Calibrator Output Level	5-40
A1R108	High Impedance Channel Level Match	5-41
A1C21	1M $\Omega$ 20 dB Attenuator 1 Matching	5-42
A1C27	1M $\Omega$ 20 dB Attenuator 2 Matching	5-42
A1C18	Input Capacitance	5-43
A1R170	LO Feedthrough	5-44

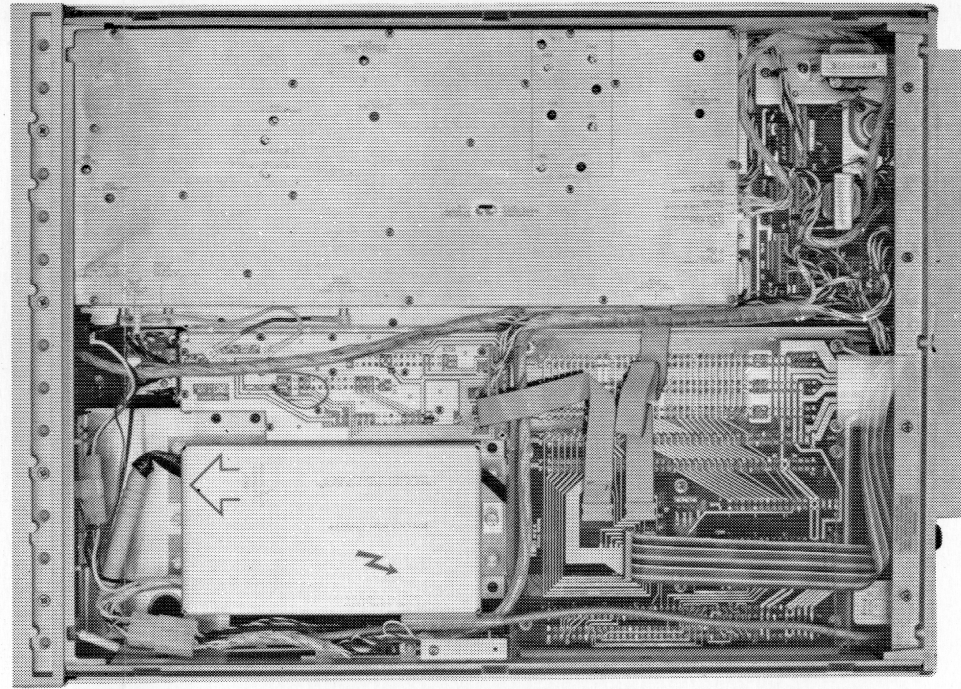
### TROUBLESHOOTING NOTES:

None

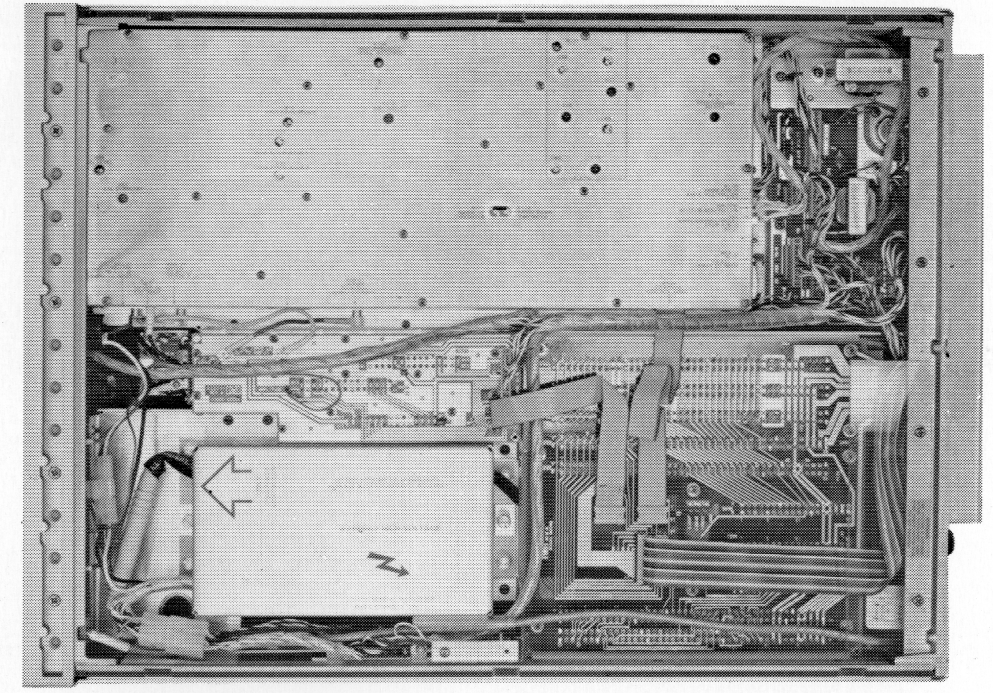


**INPUT/CONVERSION SECTION REMOVAL.**

- a. Set the 3585A LINE Switch to off.
- b. Place the instrument on its left side.
- c. Remove the bottom cover.
- d. Remove the following cables.



- f. Remove the seven mounting screws.



- e. Place a stack of books, approximately eight inches high, next to the instrument. These books will be used to support the Input/Conversion Section.

**WARNING**

*Use caution when working near the High Voltage portion of the instrument.*

- g. The Input/Conversion Section of the instrument is now free. If necessary the covers may be removed. To work on the Conversion Section, place the Input/Conversion box as shown in the photo on the left. To work on the Input Section, place the Input/Conversion box as shown in the photo on the right. Reconnect all cables for proper operation after positioning the Input/Conversion box.

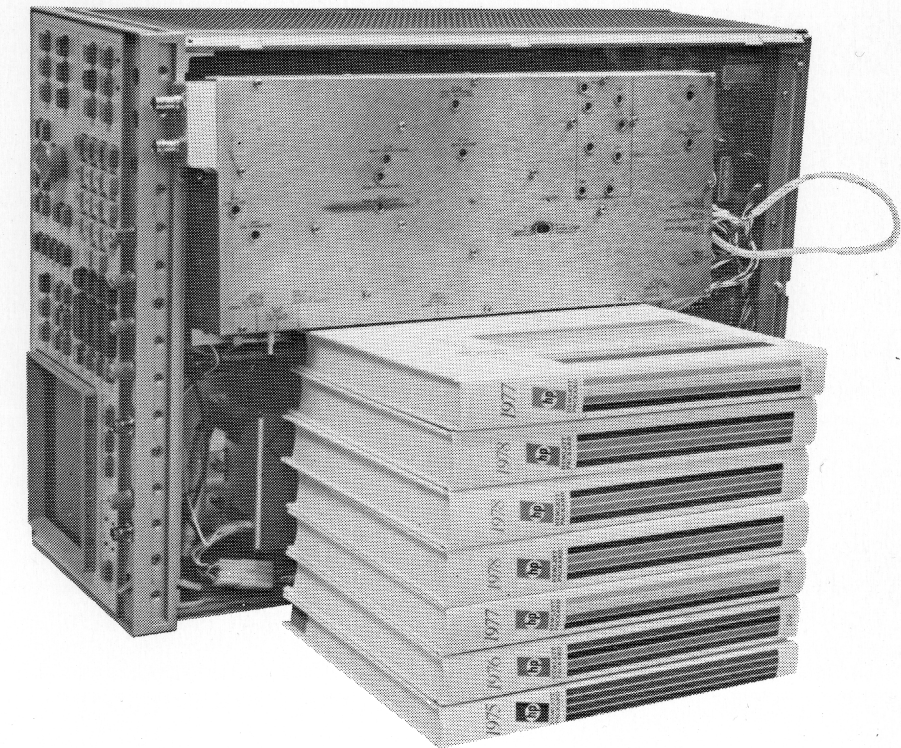
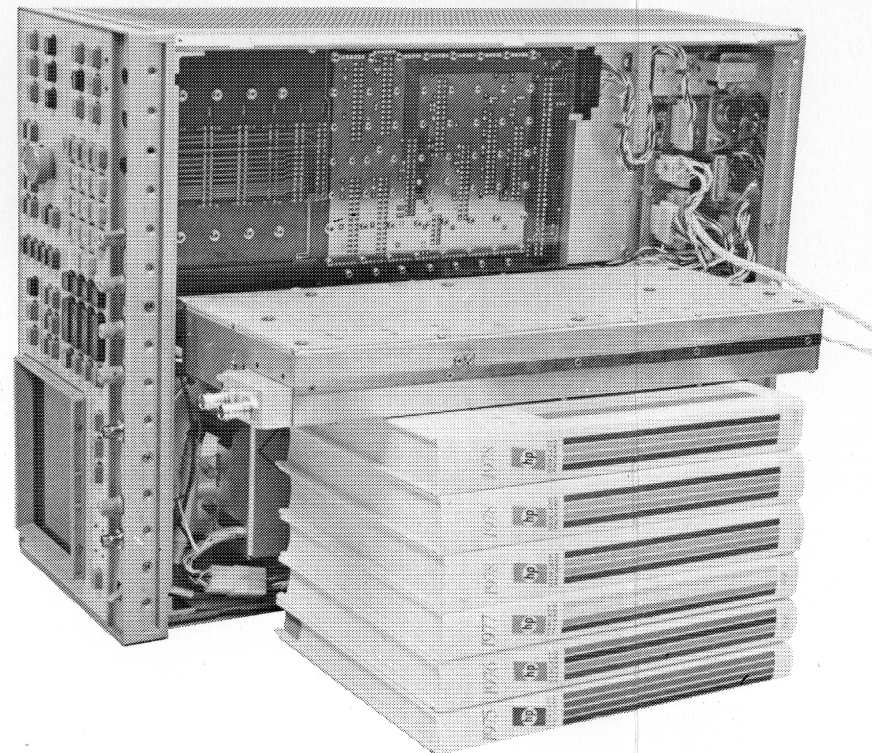
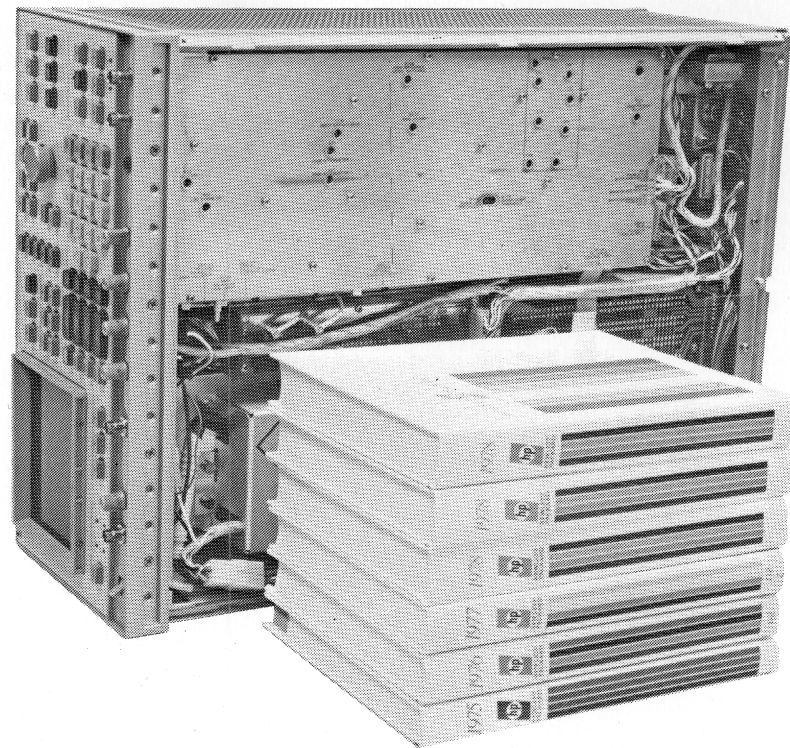
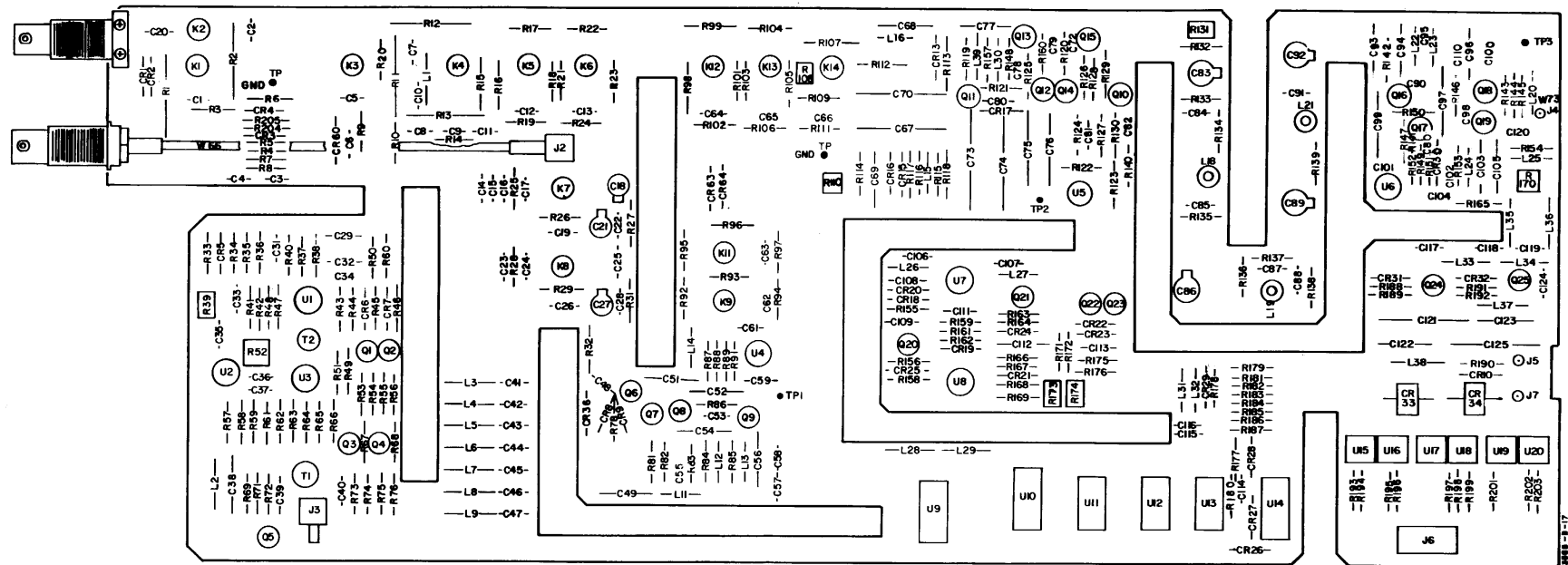
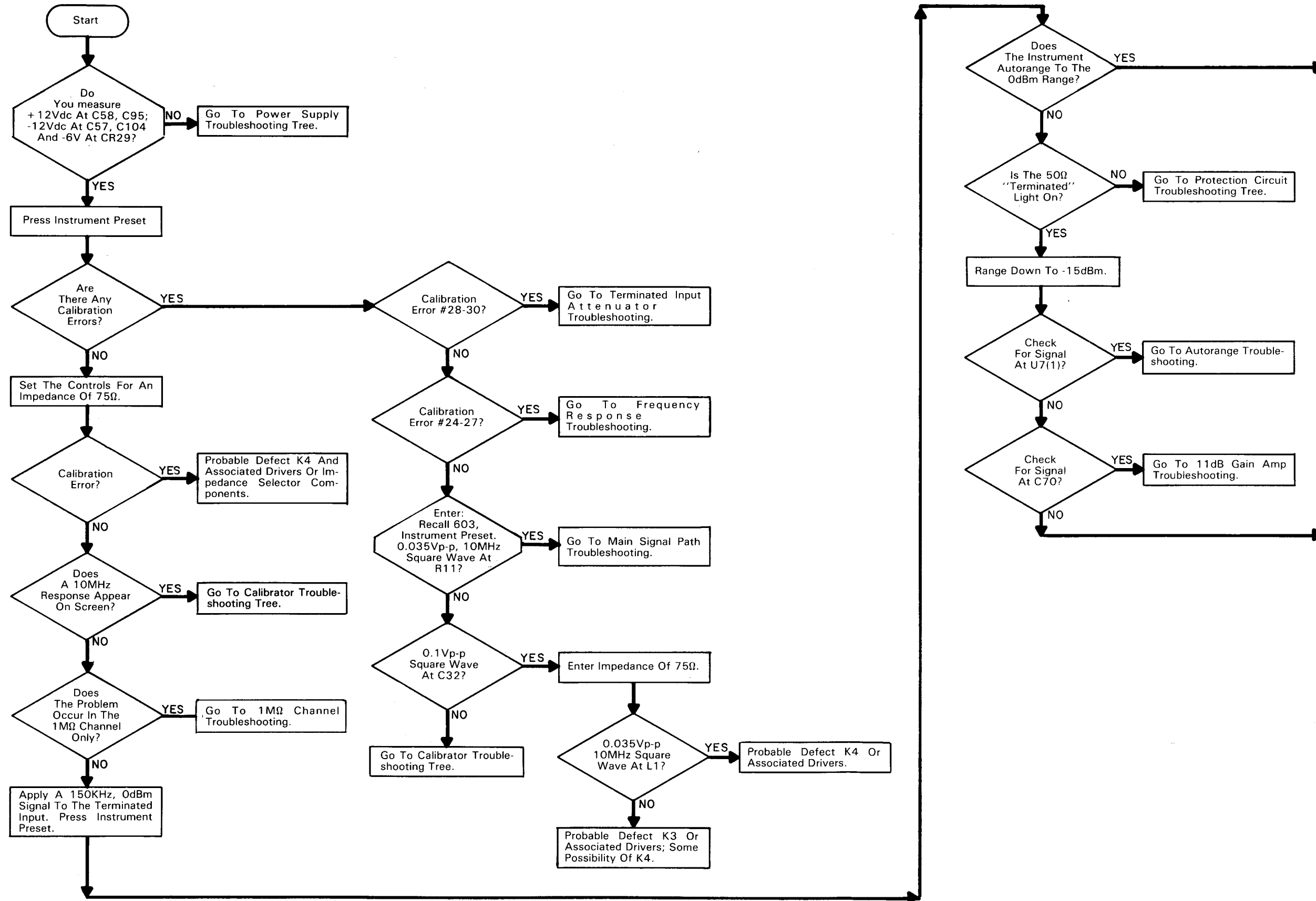


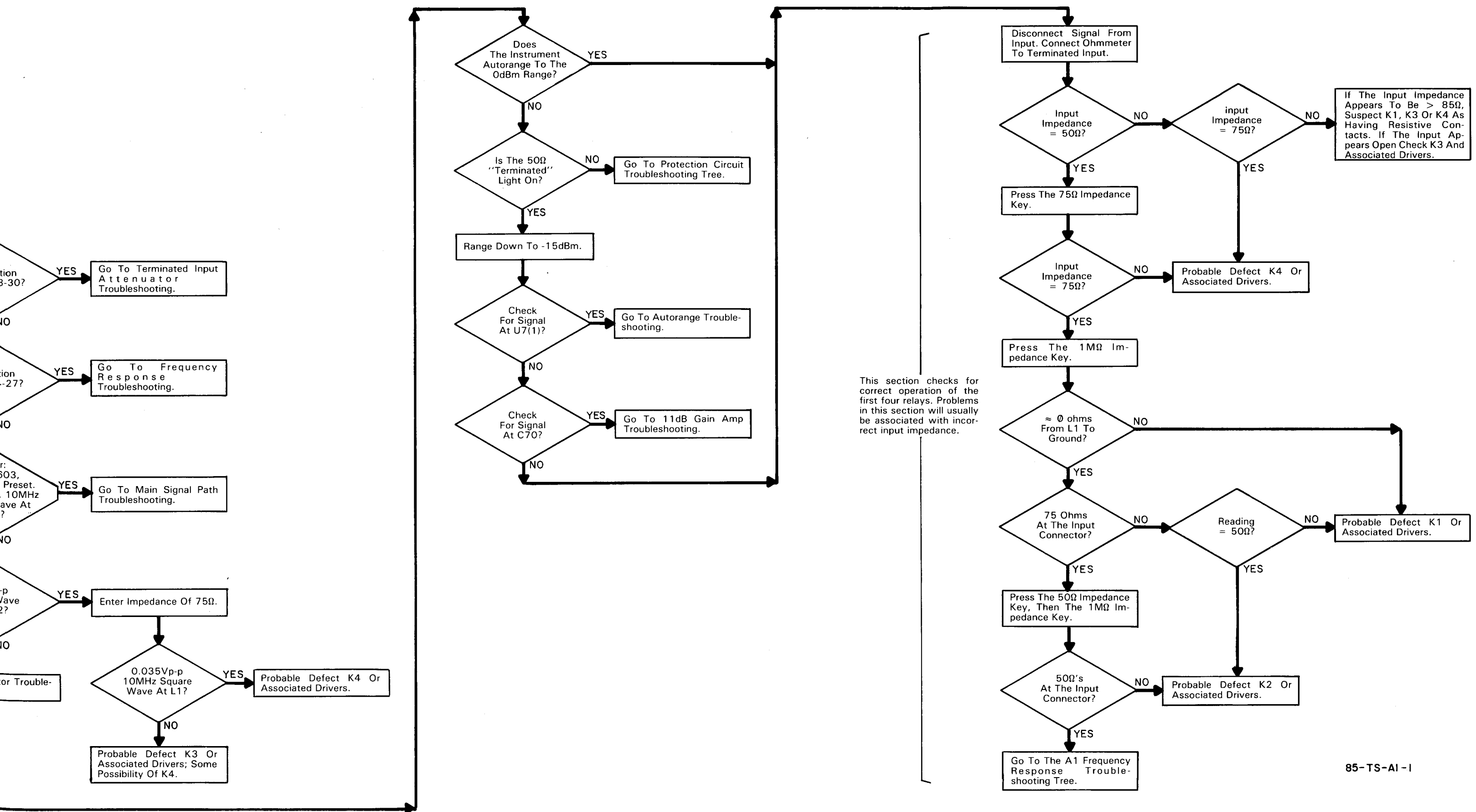
Figure 11-A-1-1. Input/Conversion Section Removal  
11-37/11-38



A1  
03585-66501

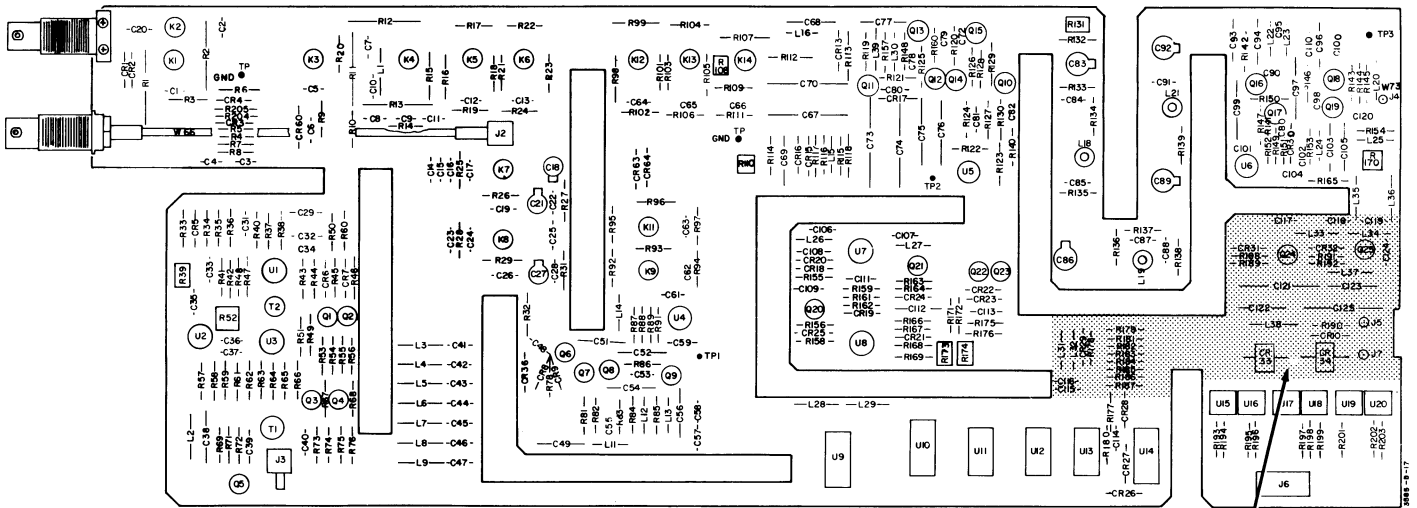


This section checks for correct operation of the first four relays. Problems in this section will be associated with incorrect input impedance.



This section checks for correct operation of the first four relays. Problems in this section will usually be associated with incorrect input impedance.

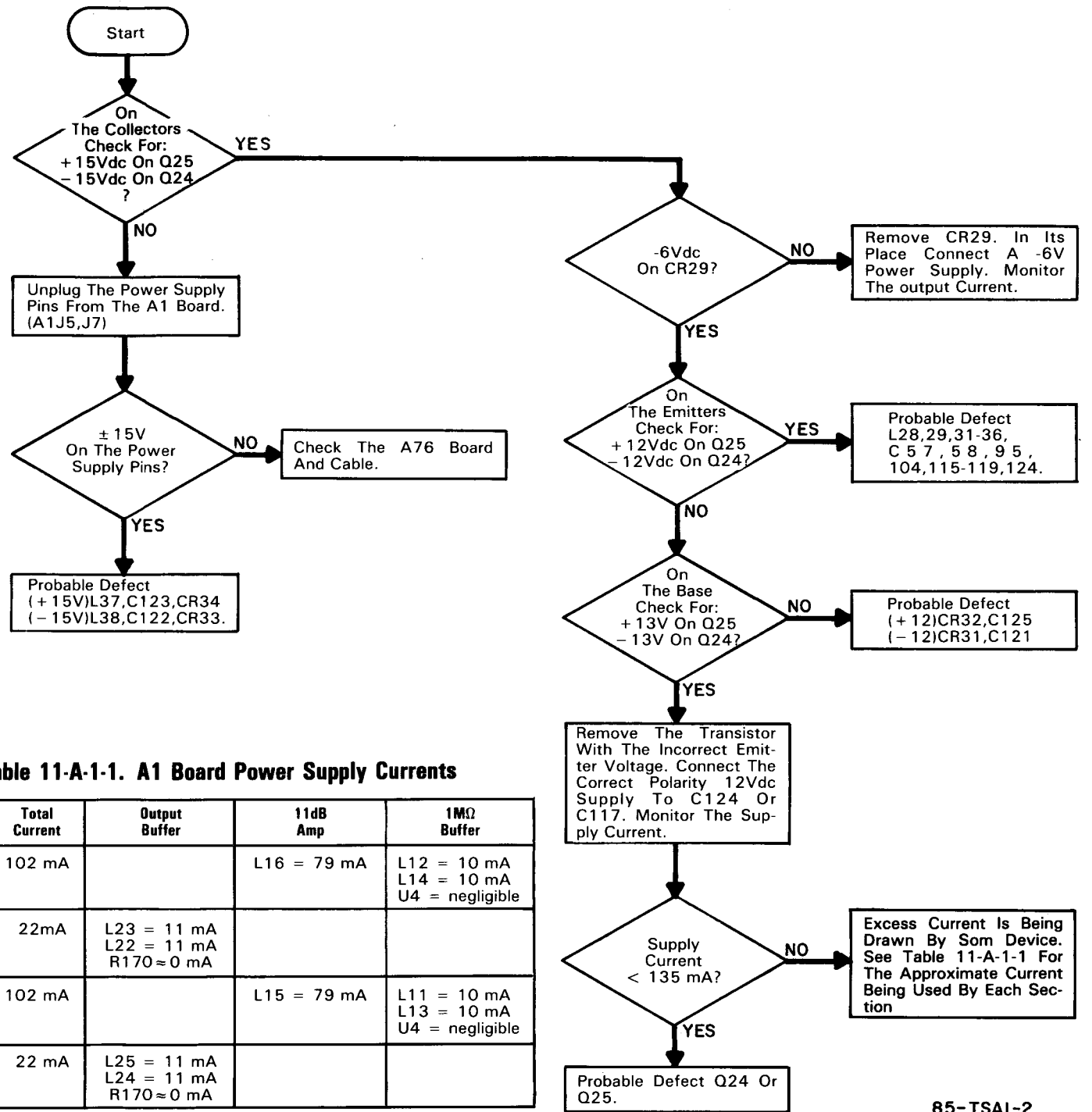
If The Input Impedance Appears To Be > 85Ω, Suspect K1, K3 Or K4 As Having Resistive Contacts. If The Input Appears Open Check K3 And Associated Drivers.



**A1**  
**03585-66501**

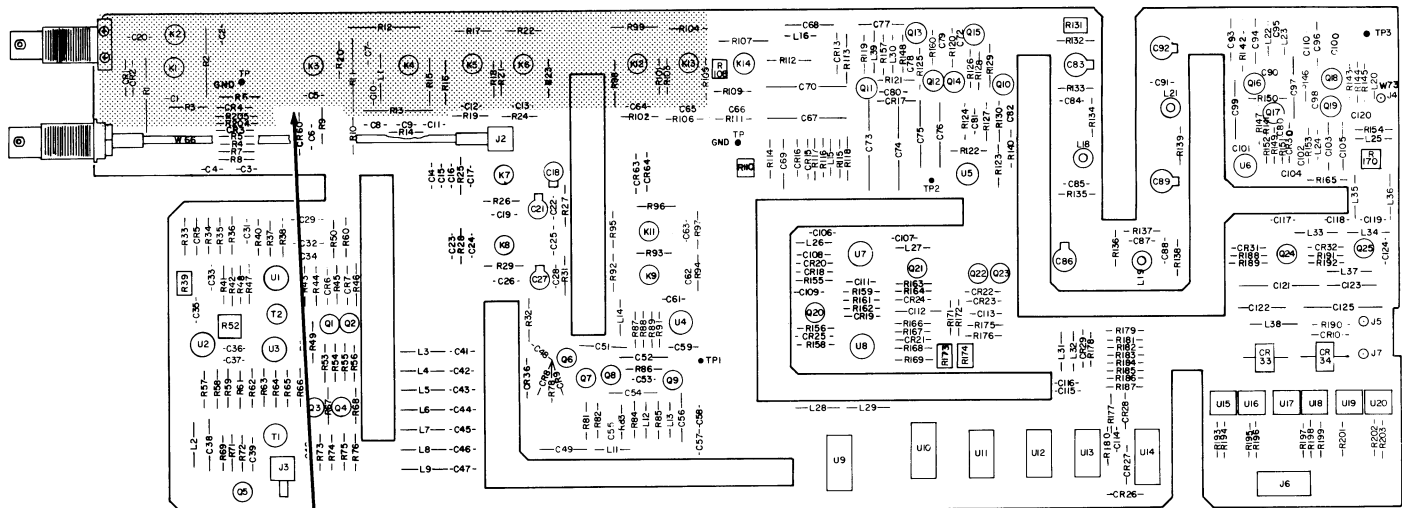
— L31 —  
— L32 —  
— L33 —  
— L34 —  
— L35 —  
— L36 —  
— L37 —  
— L38 —  
— L39 —  
— L40 —  
— L41 —  
— L42 —  
— L43 —  
— L44 —  
— L45 —  
— L46 —  
— L47 —  
— L48 —  
— L49 —  
— L50 —  
— L51 —  
— L52 —  
— L53 —  
— L54 —  
— L55 —  
— L56 —  
— L57 —  
— L58 —  
— L59 —  
— L60 —  
— L61 —  
— L62 —  
— L63 —  
— L64 —  
— L65 —  
— L66 —  
— L67 —  
— L68 —  
— L69 —  
— L70 —  
— L71 —  
— L72 —  
— L73 —  
— L74 —  
— L75 —  
— L76 —  
— L77 —  
— L78 —  
— L79 —  
— L80 —  
— L81 —  
— L82 —  
— L83 —  
— L84 —  
— L85 —  
— L86 —  
— L87 —  
— L88 —  
— L89 —  
— L90 —  
— L91 —  
— L92 —  
— L93 —  
— L94 —  
— L95 —  
— L96 —  
— L97 —  
— L98 —  
— L99 —  
— L100 —

— C117 —  
— C118 —  
— C119 —  
— C120 —  
— C121 —  
— C122 —  
— C123 —  
— C124 —  
— C125 —  
— C126 —  
— C127 —  
— C128 —  
— C129 —  
— C130 —  
— C131 —  
— C132 —  
— C133 —  
— C134 —  
— C135 —  
— C136 —  
— C137 —  
— C138 —  
— C139 —  
— C140 —  
— C141 —  
— C142 —  
— C143 —  
— C144 —  
— C145 —  
— C146 —  
— C147 —  
— C148 —  
— C149 —  
— C150 —  
— C151 —  
— C152 —  
— C153 —  
— C154 —  
— C155 —  
— C156 —  
— C157 —  
— C158 —  
— C159 —  
— C160 —  
— C161 —  
— C162 —  
— C163 —  
— C164 —  
— C165 —  
— C166 —  
— C167 —  
— C168 —  
— C169 —  
— C170 —  
— C171 —  
— C172 —  
— C173 —  
— C174 —  
— C175 —  
— C176 —  
— C177 —  
— C178 —  
— C179 —  
— C180 —  
— C181 —  
— C182 —  
— C183 —  
— C184 —  
— C185 —  
— C186 —  
— C187 —  
— C188 —  
— C189 —  
— C190 —  
— C191 —  
— C192 —  
— C193 —  
— C194 —  
— C195 —  
— C196 —  
— C197 —  
— C198 —  
— C199 —  
— C200 —

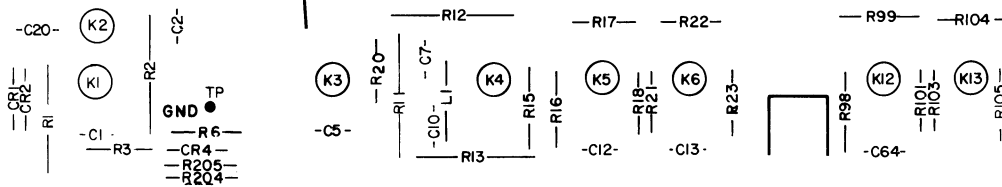


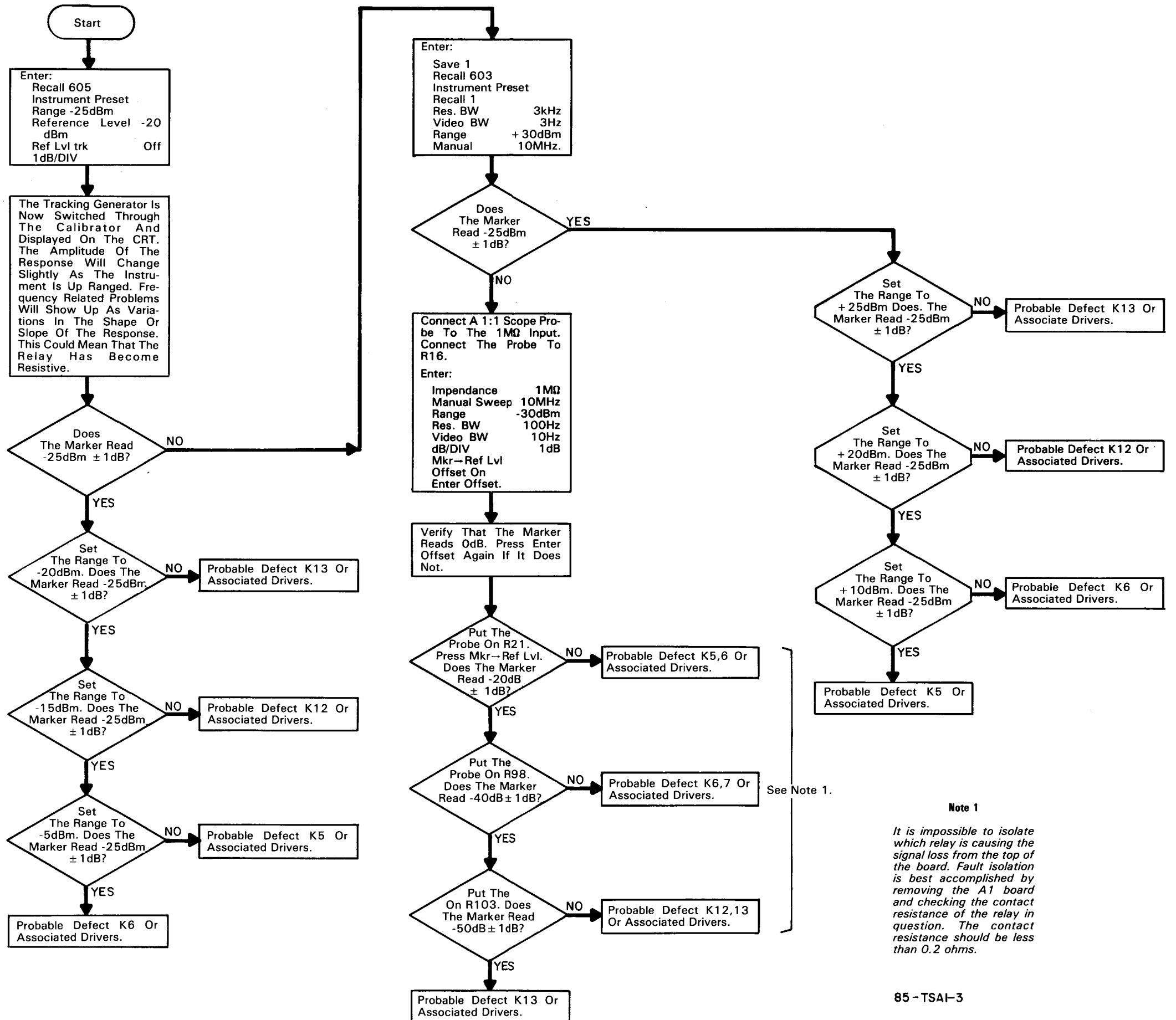
**Table 11-A-1-1. A1 Board Power Supply Currents**

Supply Voltage	Total Current	Output Buffer	11dB Amp	1MΩ Buffer
+12V <sub>1</sub>	102 mA		L16 = 79 mA	L12 = 10 mA L14 = 10 mA U4 = negligible
+12V <sub>2</sub>	22mA	L23 = 11 mA L22 = 11 mA R170 ≈ 0 mA		
-12V <sub>1</sub>	102 mA		L15 = 79 mA	L11 = 10 mA L13 = 10 mA U4 = negligible
-12V <sub>2</sub>	22 mA	L25 = 11 mA L24 = 11 mA R170 ≈ 0 mA		

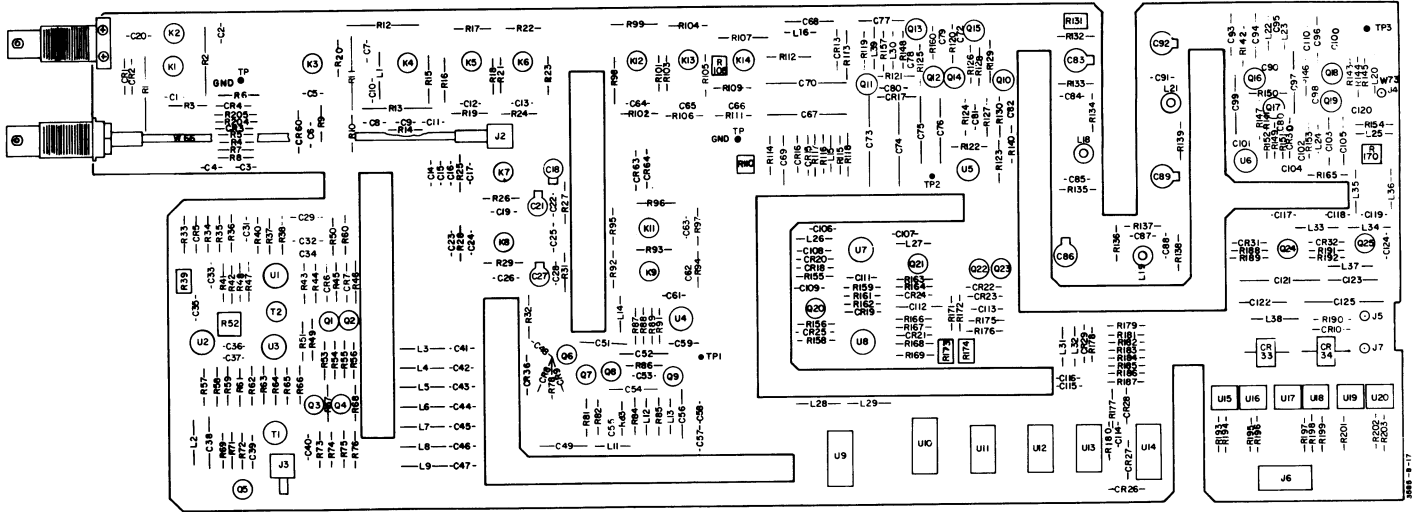


**A1**  
**03585-66501**



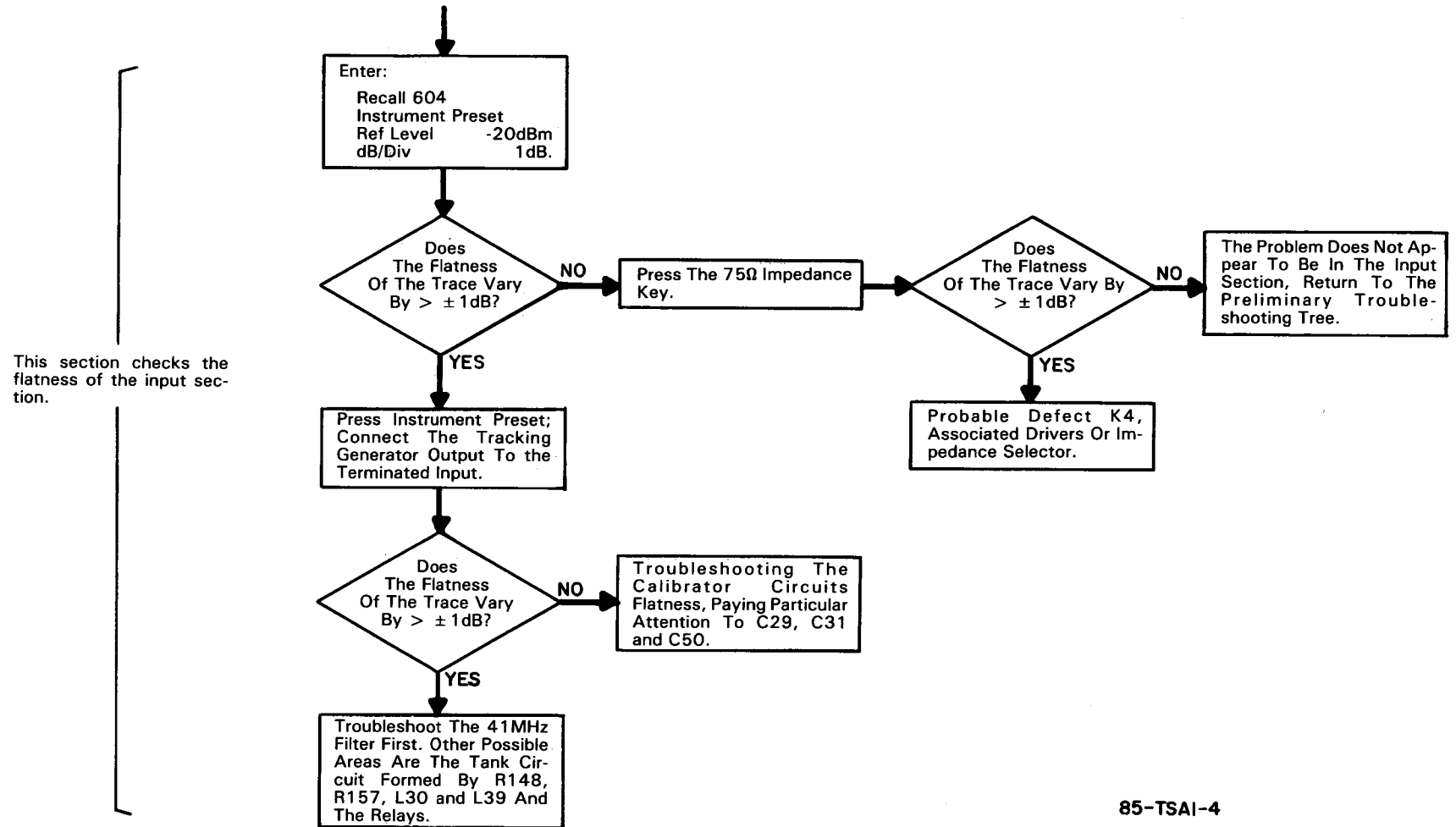


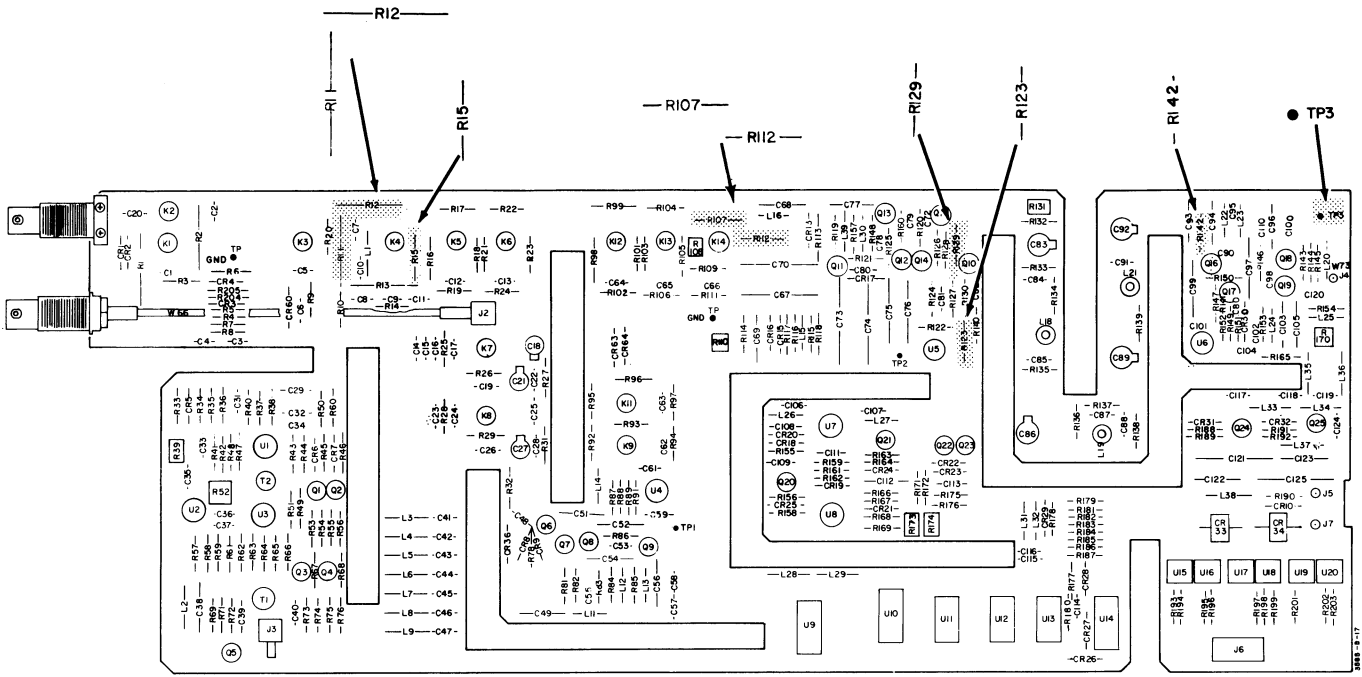




A1  
03585-66501

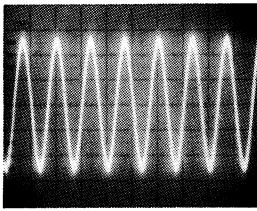
### A1 Frequency Response Troubleshooting Tree





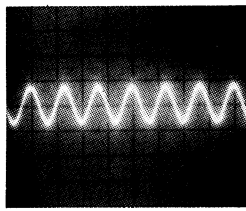
**A1**  
**03585-66501**

1



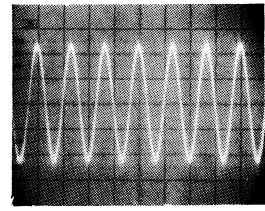
5  $\mu$ sec/DIV  
0.01 volts/DIV

2



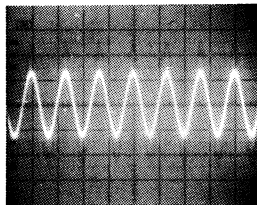
dc Coupled  
5  $\mu$ sec/DIV  
0.5 volts/DIV

3



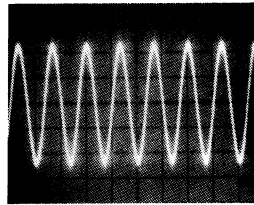
5  $\mu$ sec/DIV  
0.01 volts/DIV

4



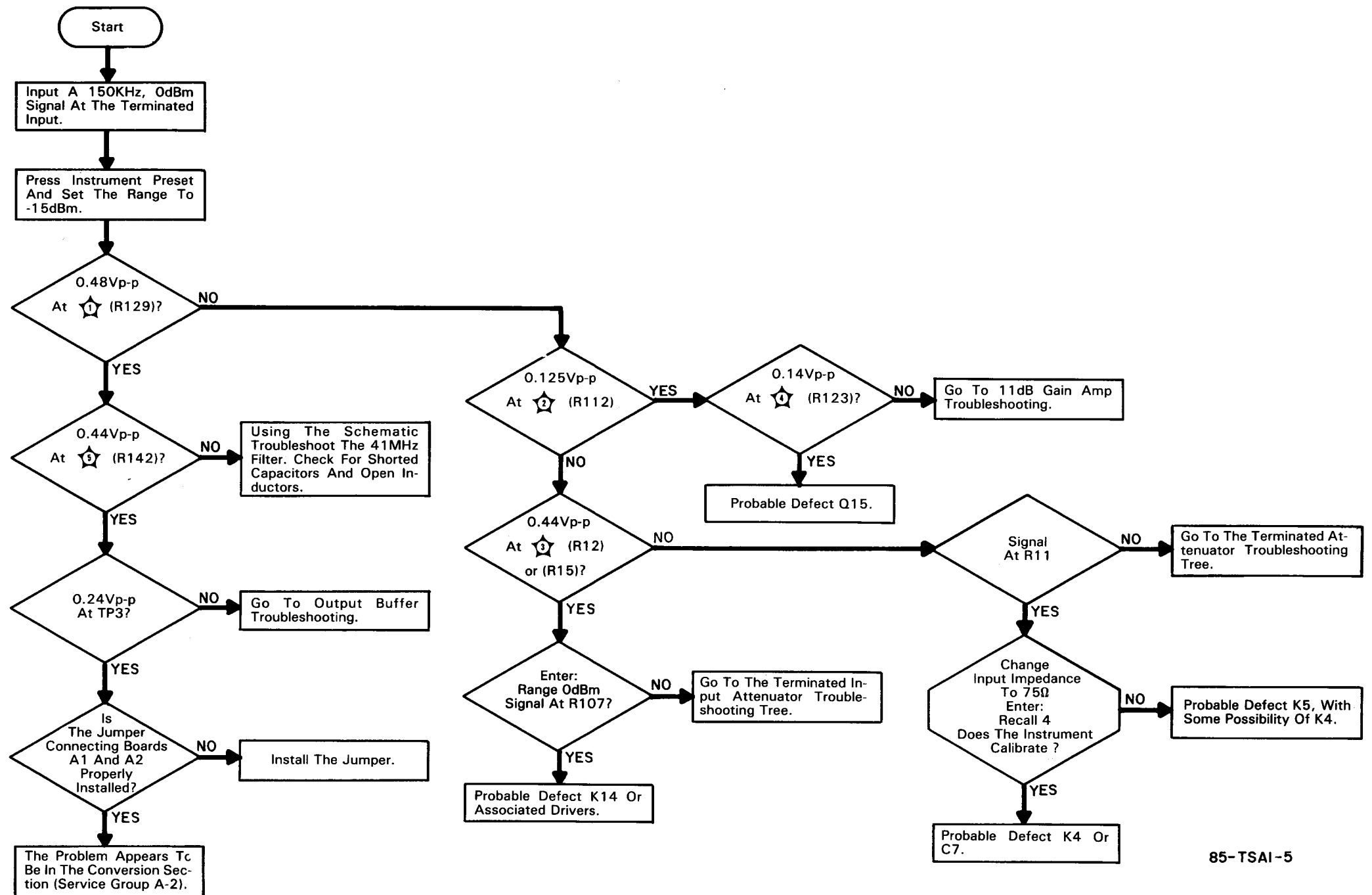
5  $\mu$ sec/DIV  
0.01 volts/DIV

5

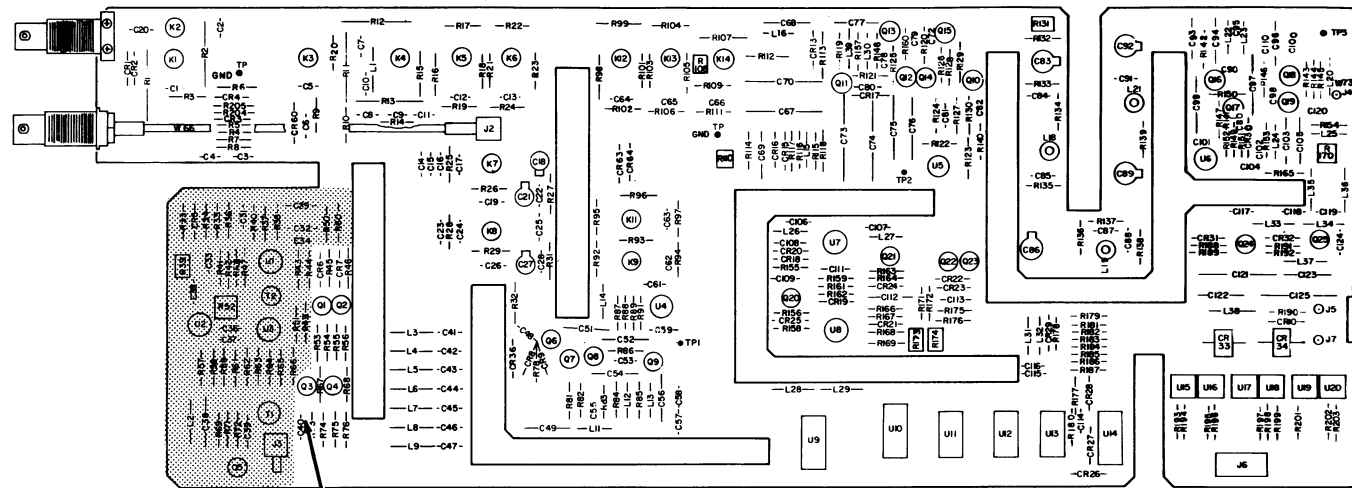


0.1  $\mu$ sec/DIV  
0.005 volts/DIV

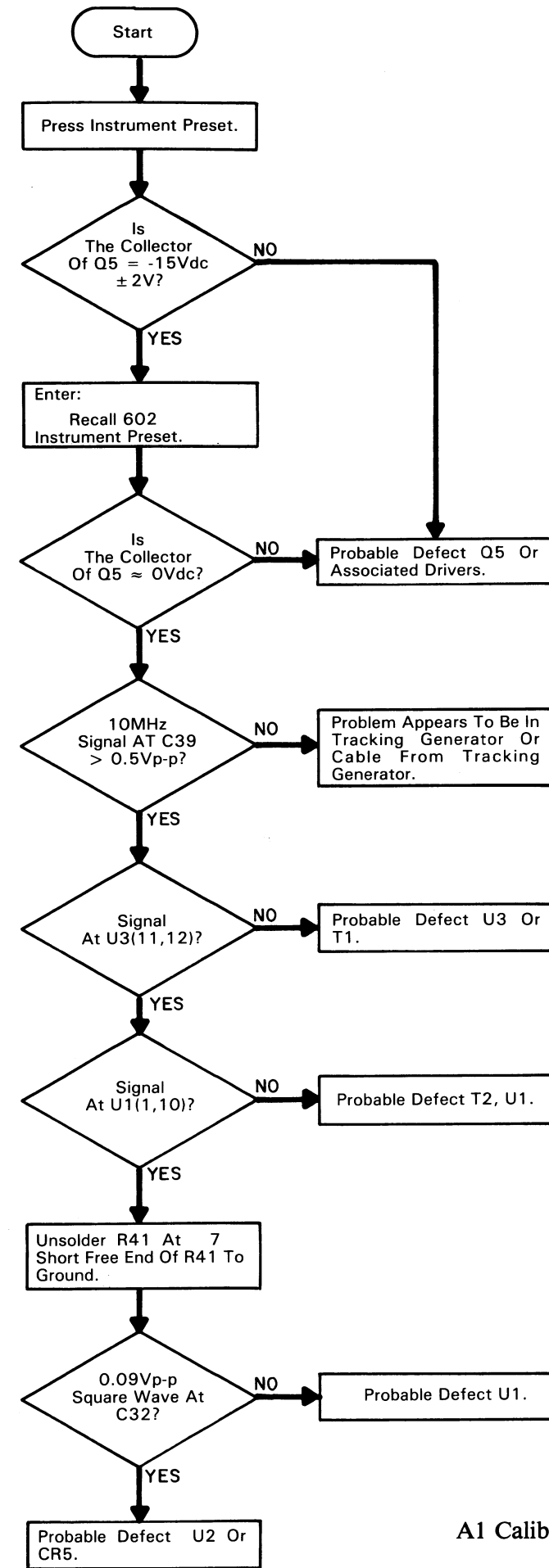
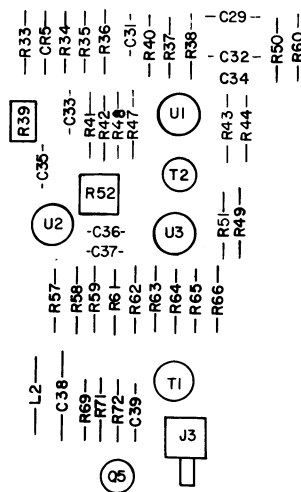
**NOTE**  
Refer to the component locator and schematic for locations.

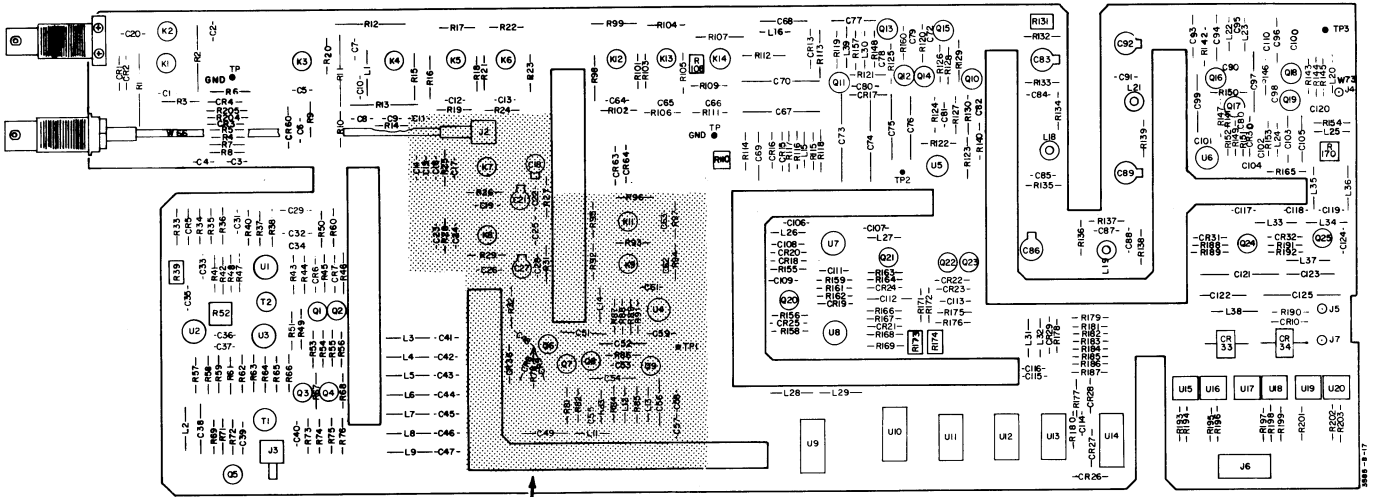


85-TSAI-5

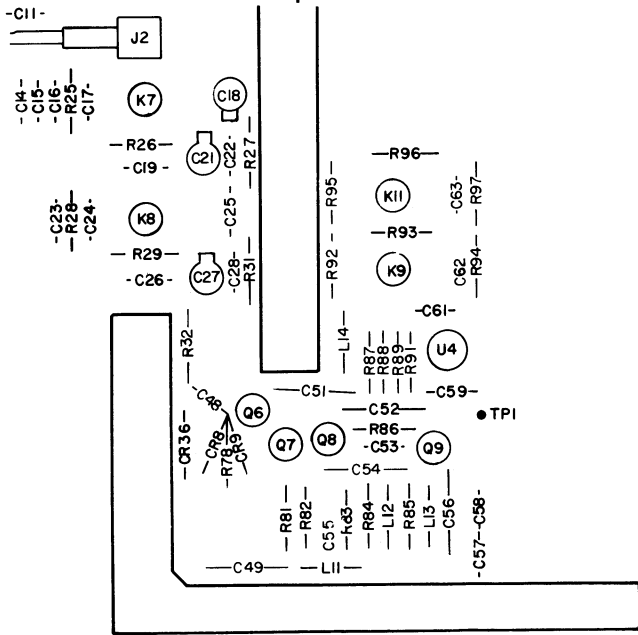


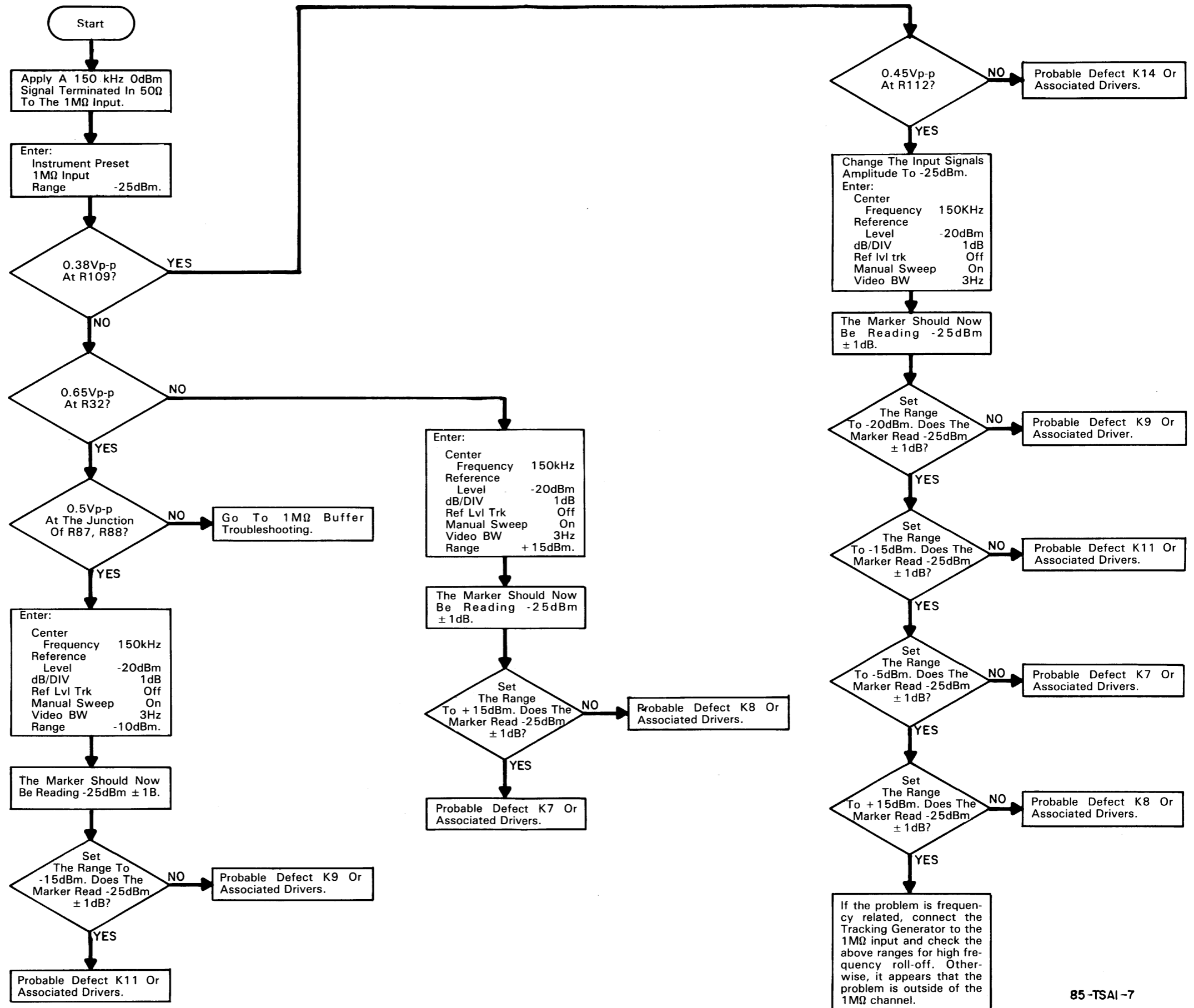
A1  
03585-66501

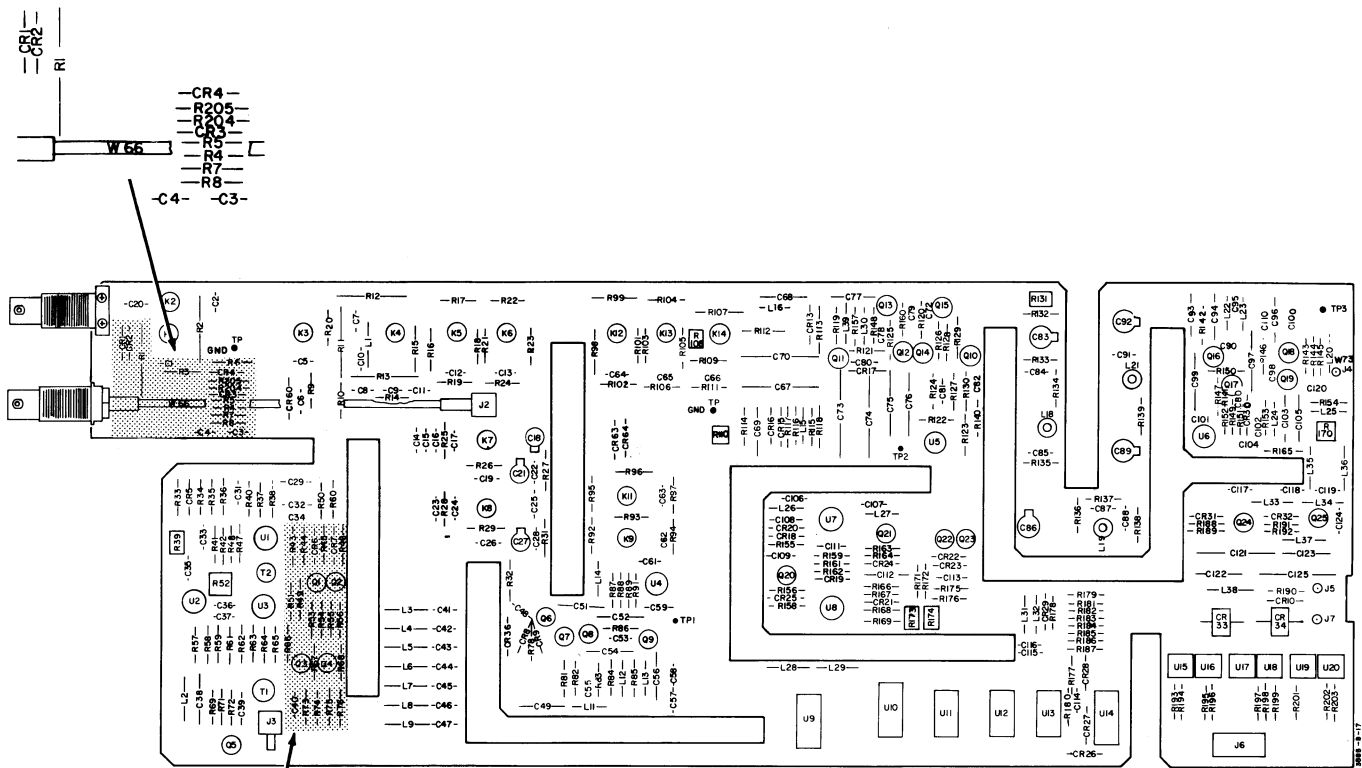




**A1**  
**03585-66501**





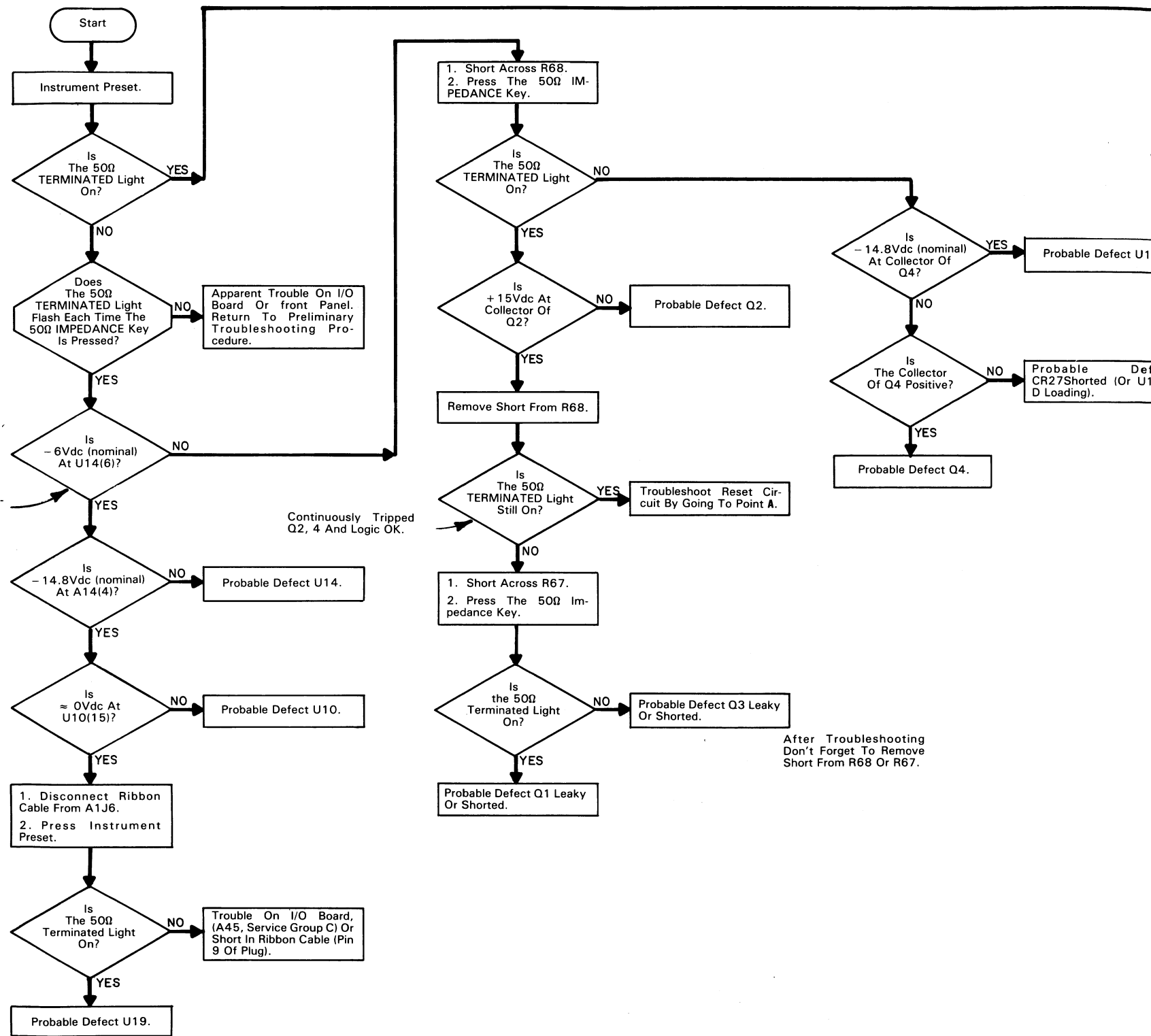


A1  
03585-66501

NOTE

The circuit is not really tripped, the logic is hung up.

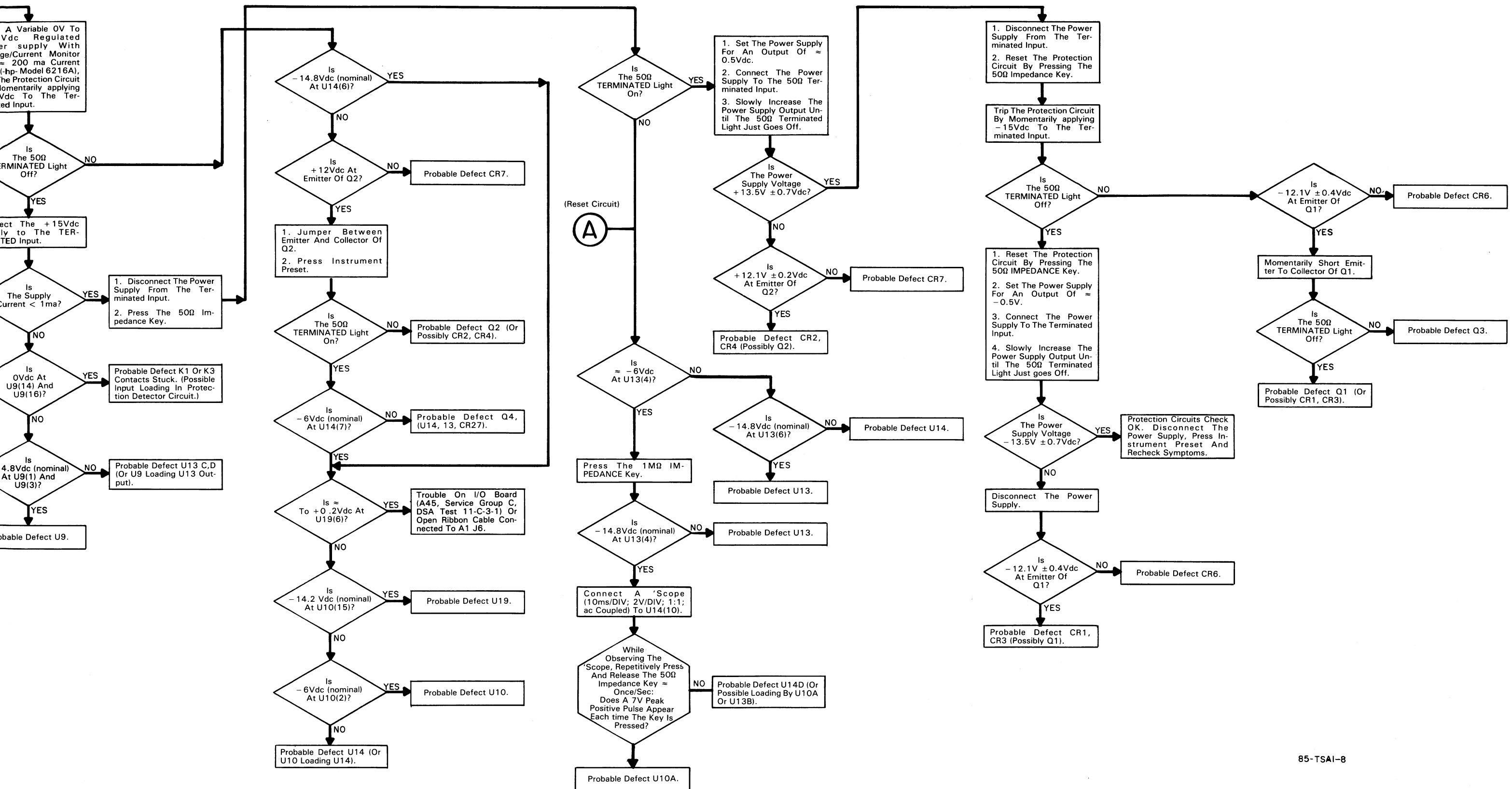
- R43
- R44
- R45
- R46
- R47
- R48
- R49
- R50
- R51
- R52
- R53
- R54
- R55
- R56
- R57
- R58
- R59
- R60
- R61
- R62
- R63
- R64
- R65
- R66
- R67
- R68
- R69
- R70
- R71
- R72
- R73
- R74
- R75
- R76
- R77
- R78
- R79
- R80
- R81
- R82
- R83
- R84
- R85
- R86
- R87
- R88
- R89
- R90
- R91
- R92
- R93
- R94
- R95
- R96
- R97
- R98
- R99
- R100
- R101
- R102
- R103
- R104
- R105
- R106
- R107
- R108
- R109
- R110
- R111
- R112
- R113
- R114
- R115
- R116
- R117
- R118
- R119
- R120
- R121
- R122
- R123
- R124
- R125
- R126
- R127
- R128
- R129
- R130
- R131
- R132
- R133
- R134
- R135
- R136
- R137
- R138
- R139
- R140
- R141
- R142
- R143
- R144
- R145
- R146
- R147
- R148
- R149
- R150
- R151
- R152
- R153
- R154
- R155
- R156
- R157
- R158
- R159
- R160
- R161
- R162
- R163
- R164
- R165
- R166
- R167
- R168
- R169
- R170
- R171
- R172
- R173
- R174
- R175
- R176
- R177
- R178
- R179
- R180
- R181
- R182
- R183
- R184
- R185
- R186
- R187
- R188
- R189
- R190
- R191
- R192
- R193
- R194
- R195
- R196
- R197
- R198
- R199
- R200
- R201
- R202
- R203
- R204
- R205
- R206
- R207
- R208
- R209
- R210
- R211
- R212
- R213
- R214
- R215
- R216
- R217
- R218
- R219
- R220
- R221
- R222
- R223
- R224
- R225
- R226
- R227
- R228
- R229
- R230
- R231
- R232
- R233
- R234
- R235
- R236
- R237
- R238
- R239
- R240
- R241
- R242
- R243
- R244
- R245
- R246
- R247
- R248
- R249
- R250
- R251
- R252
- R253
- R254
- R255
- R256
- R257
- R258
- R259
- R260
- R261
- R262
- R263
- R264
- R265
- R266
- R267
- R268
- R269
- R270
- R271
- R272
- R273
- R274
- R275
- R276
- R277
- R278
- R279
- R280
- R281
- R282
- R283
- R284
- R285
- R286
- R287
- R288
- R289
- R290
- R291
- R292
- R293
- R294
- R295
- R296
- R297
- R298
- R299
- R300

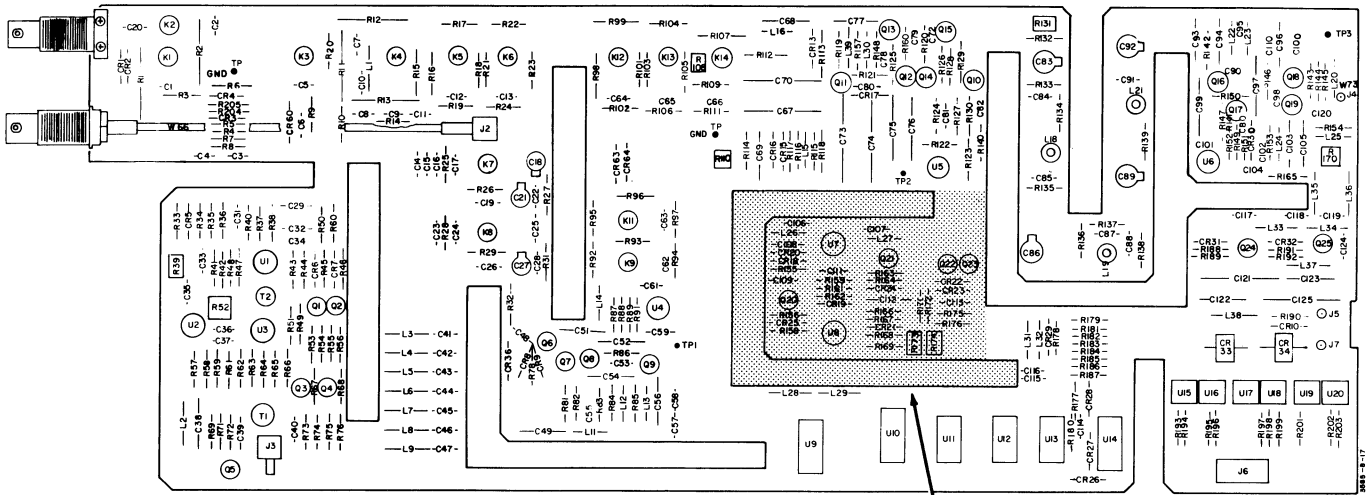


Continuously Tripped Q2, 4 And Logic OK.

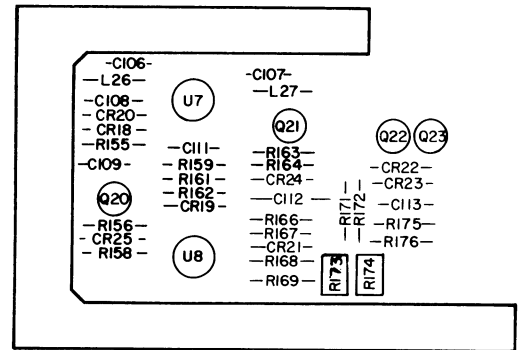
After Troubleshooting Don't Forget To Remove Short From R68 Or R67.

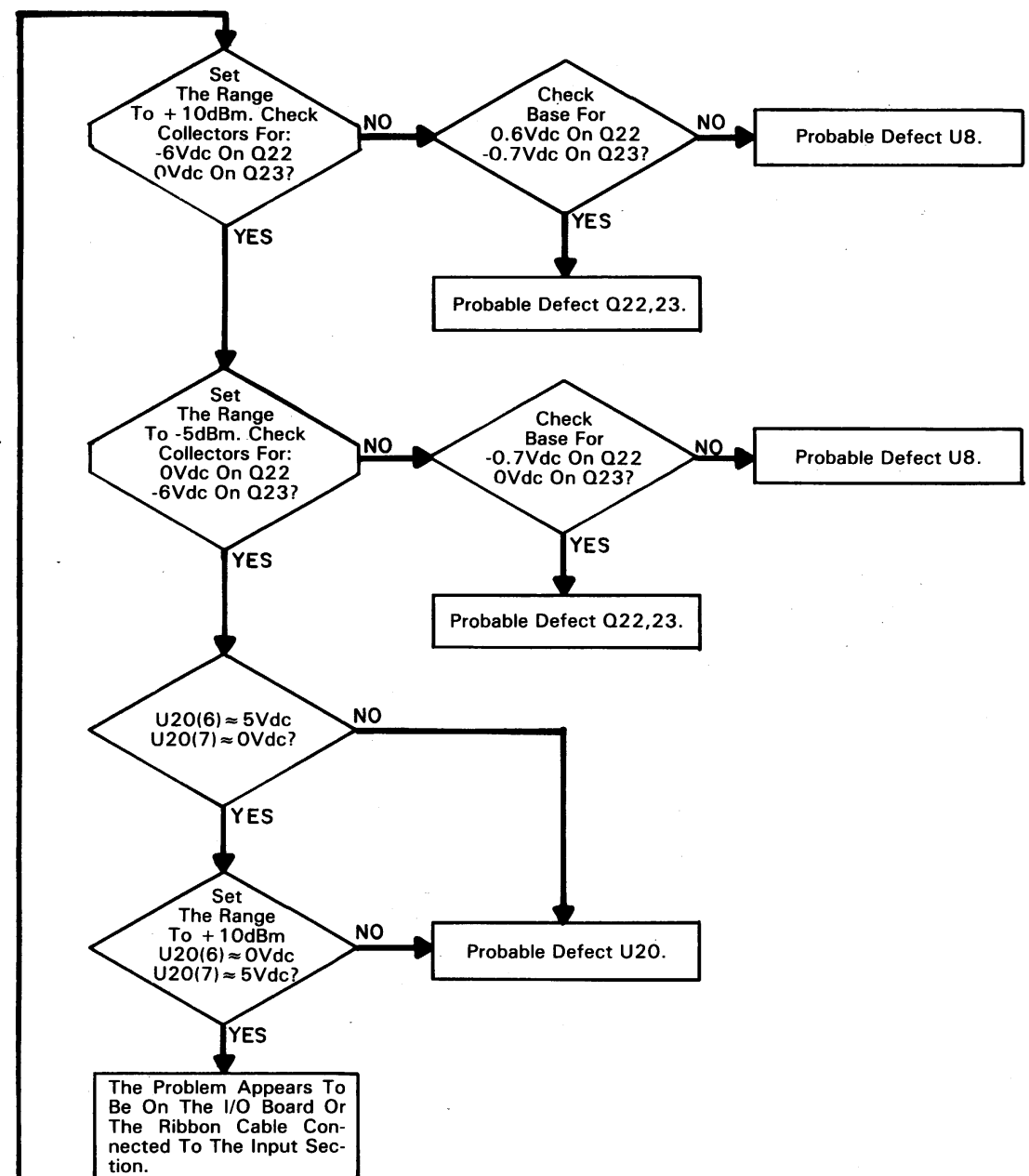
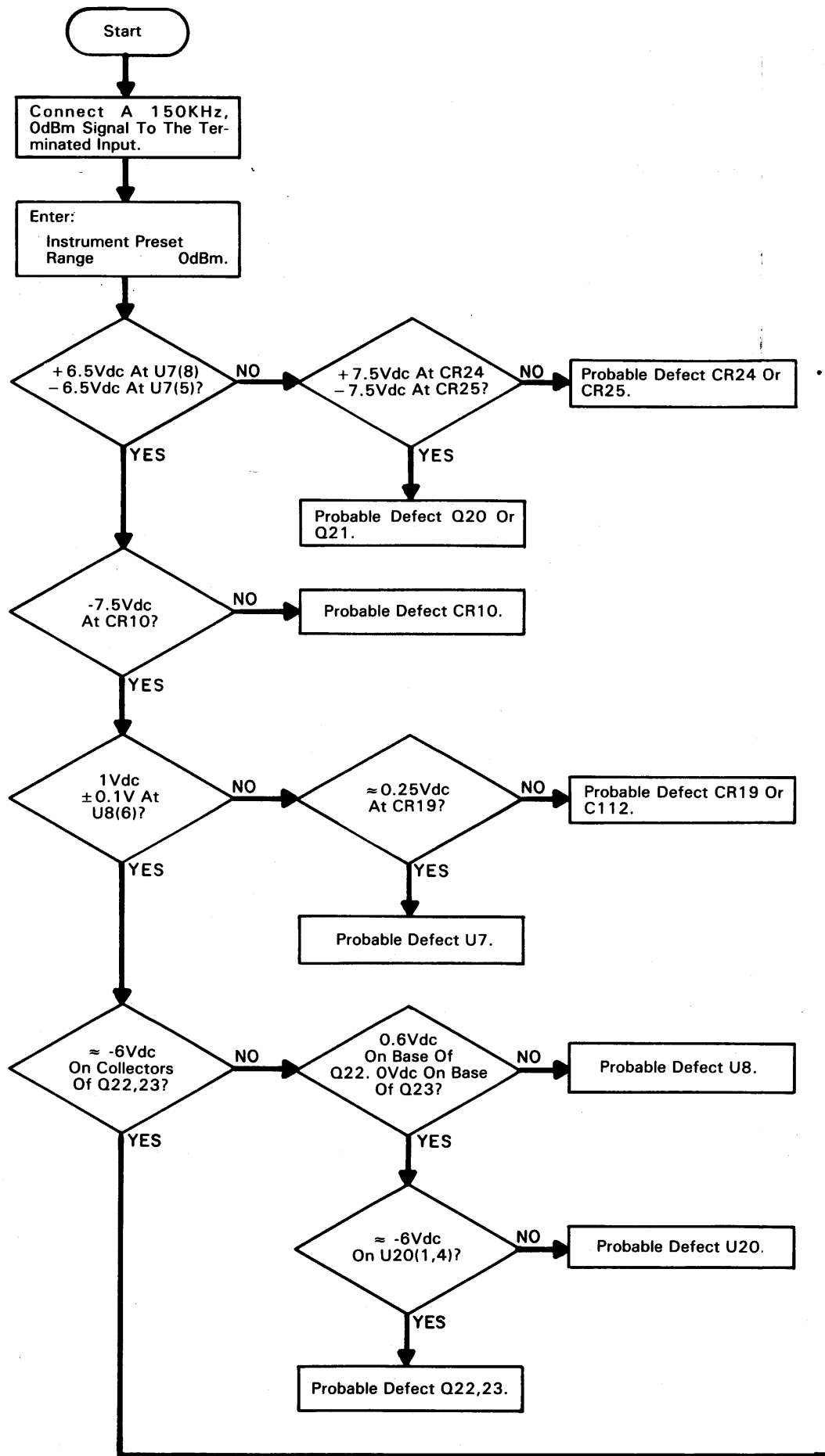


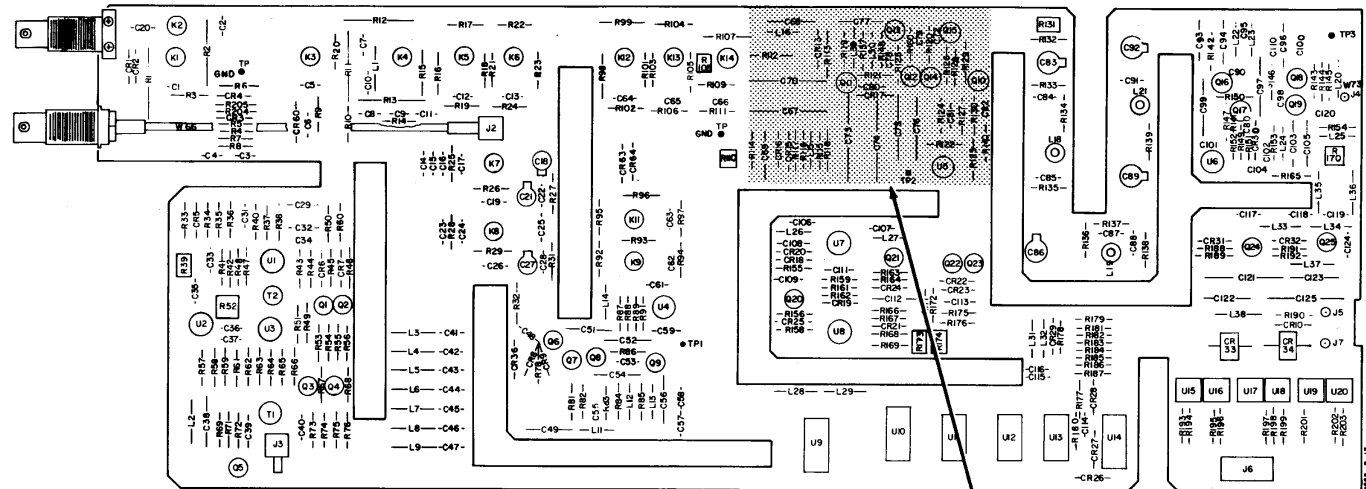




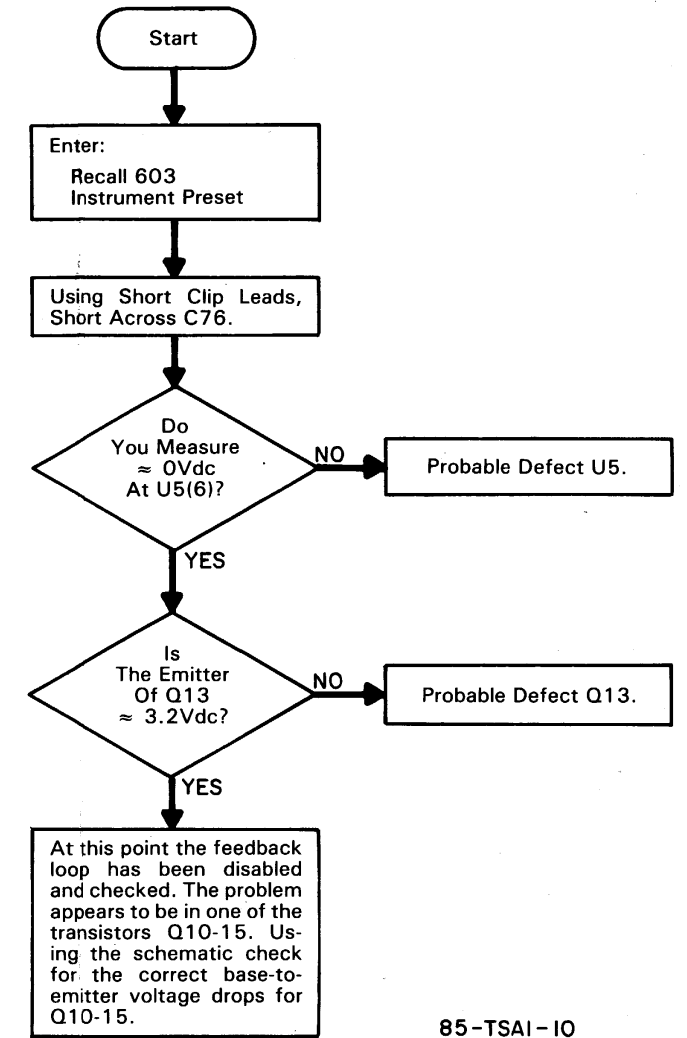
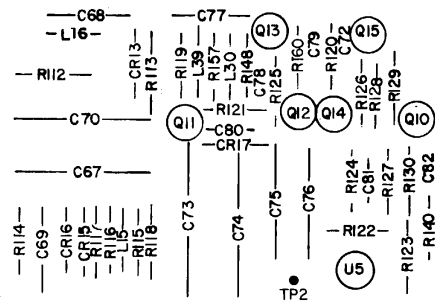
**A1**  
**03585-66501**



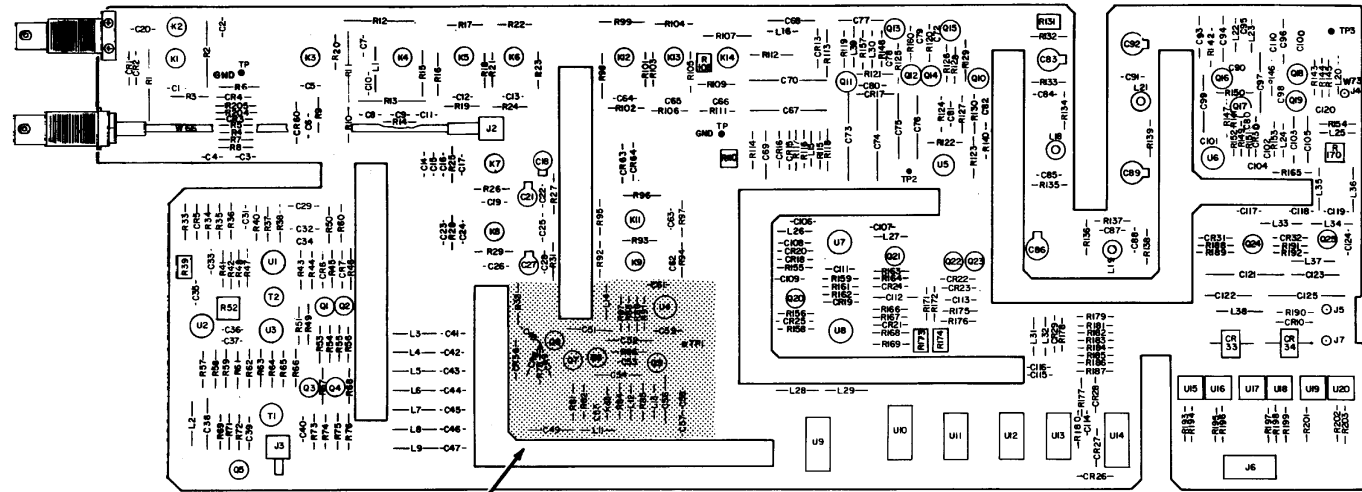




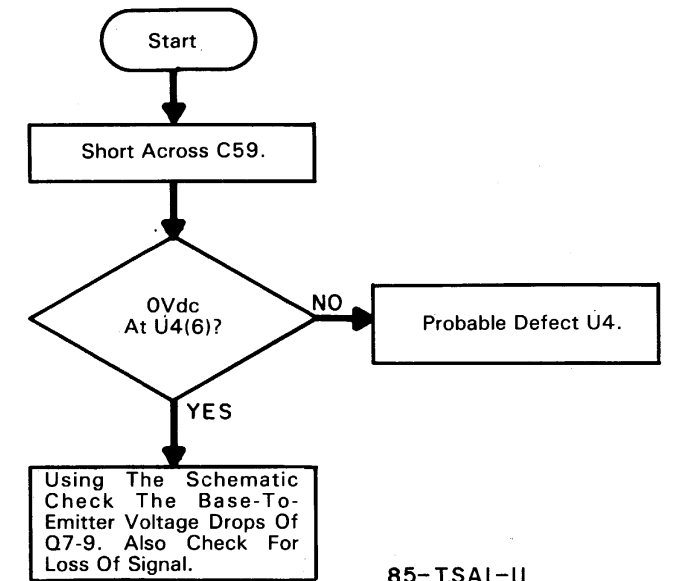
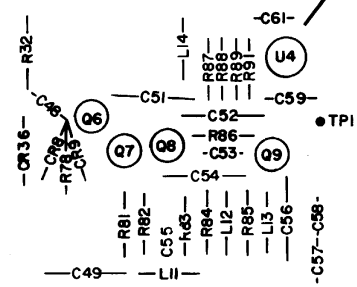
A1  
03585-86501



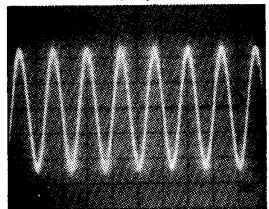
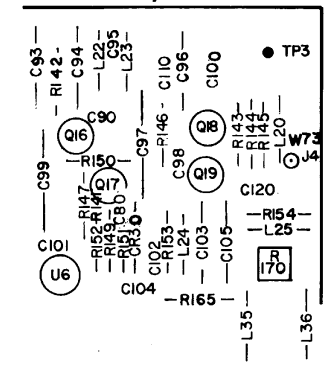
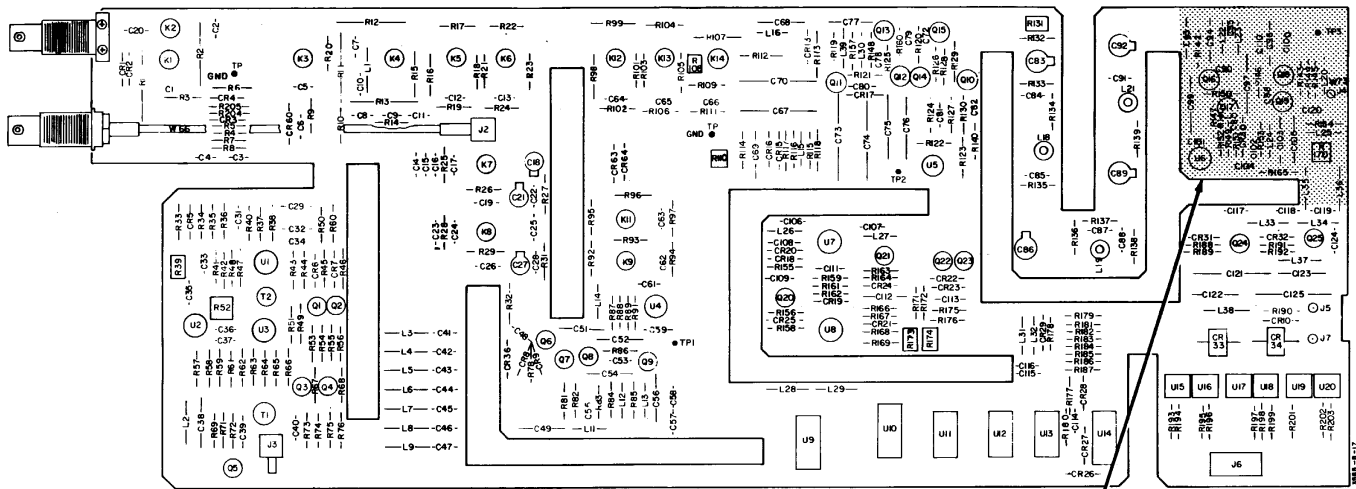
85-TSA1-10



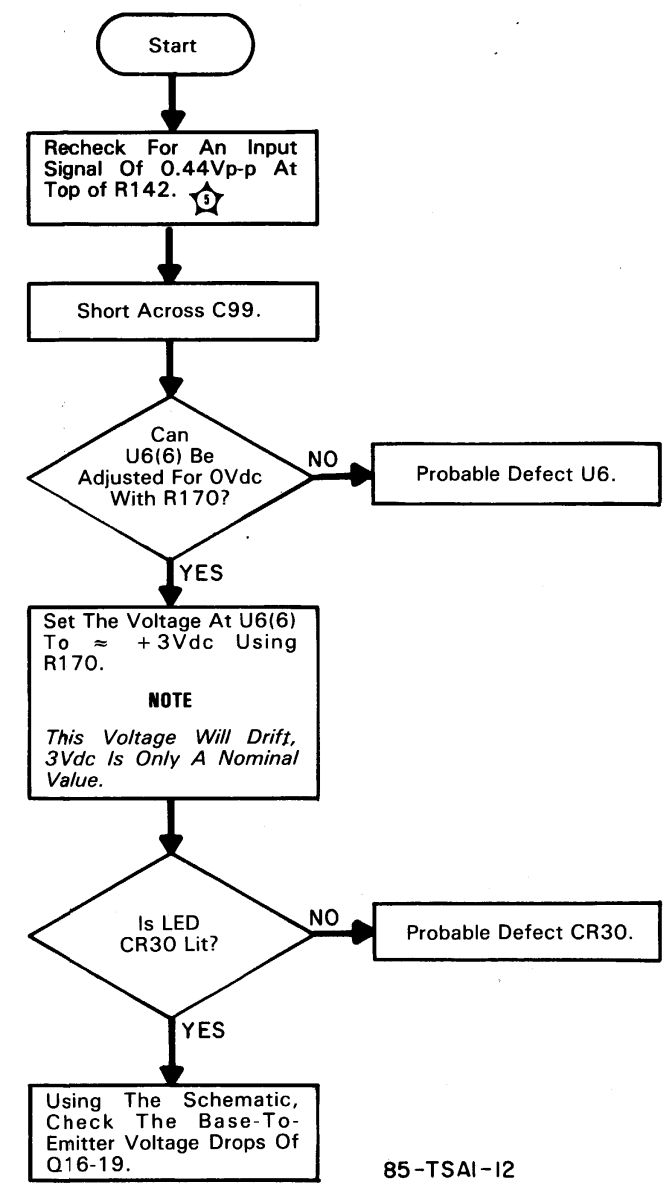
A1  
03585-86501



85-TSA1-11

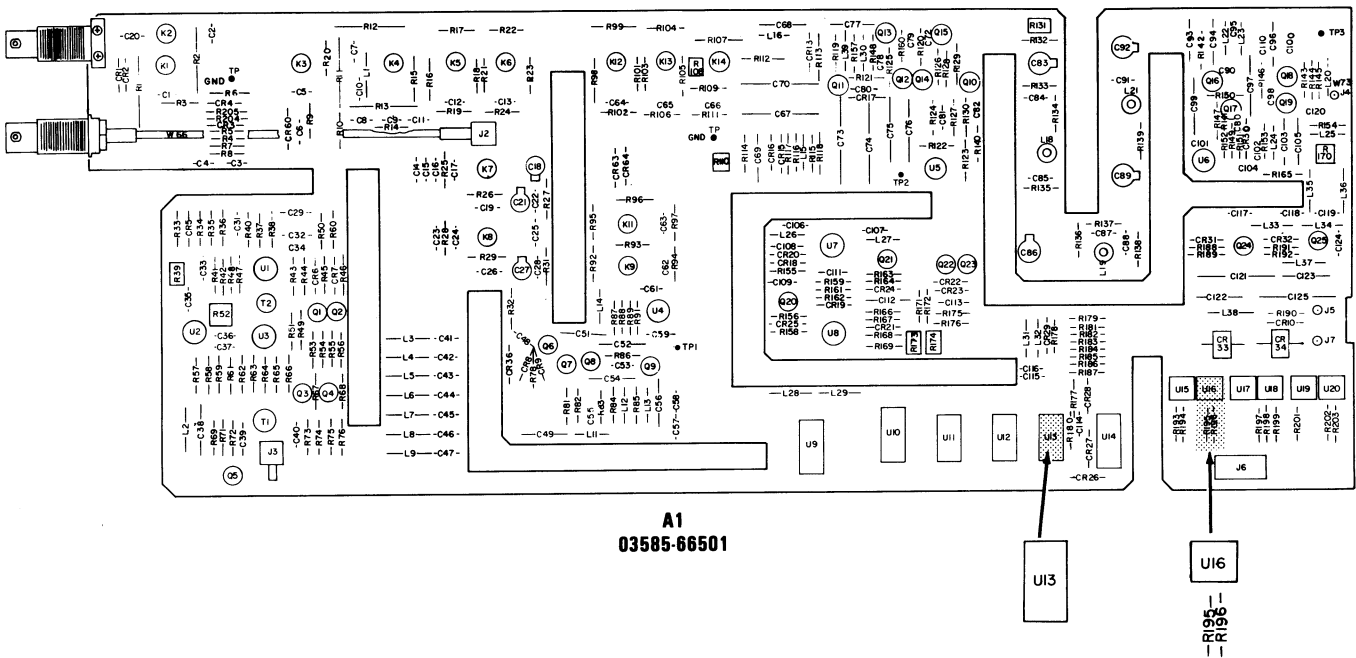


0.1 μsec/DIV  
0.005 volts/DIV



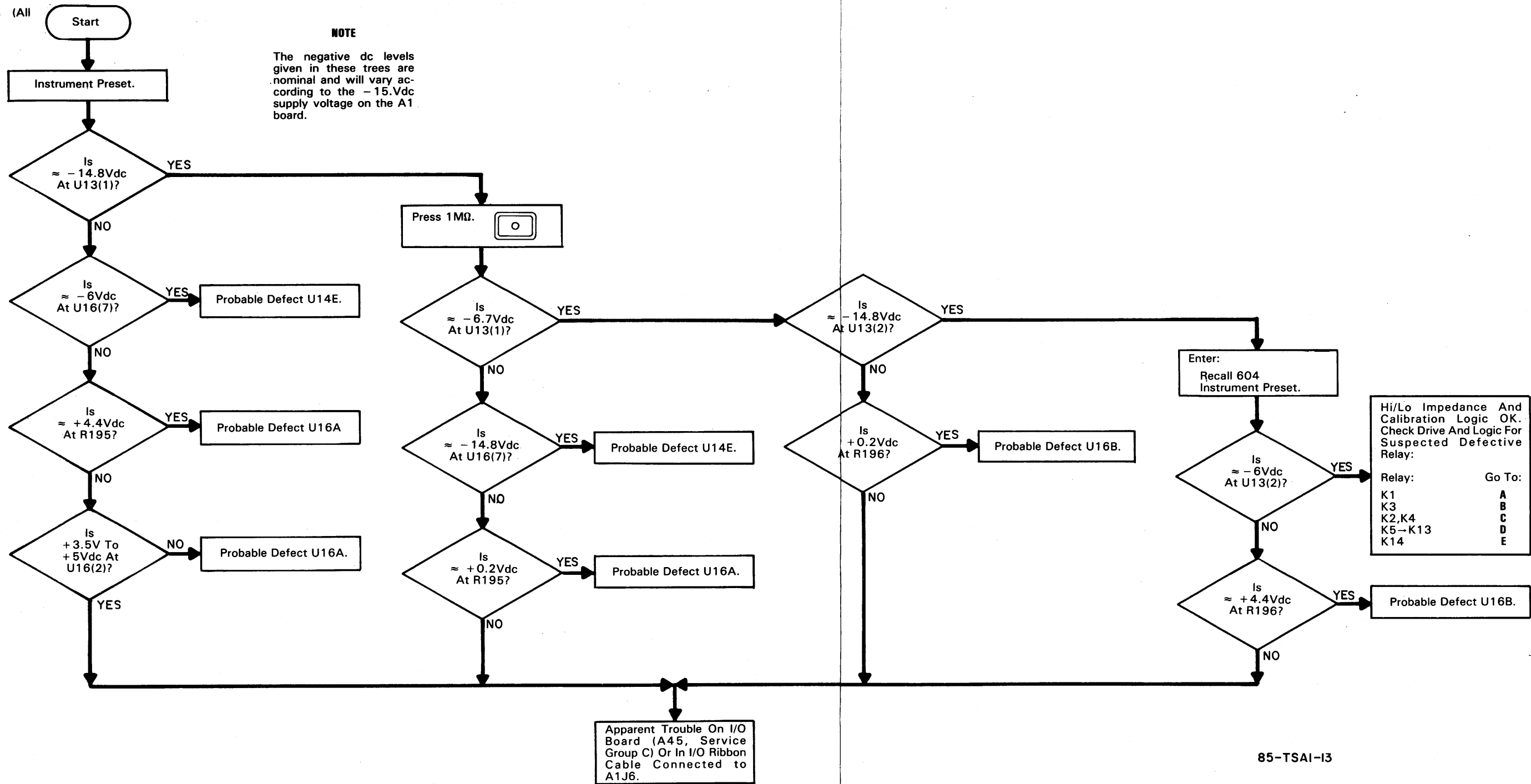
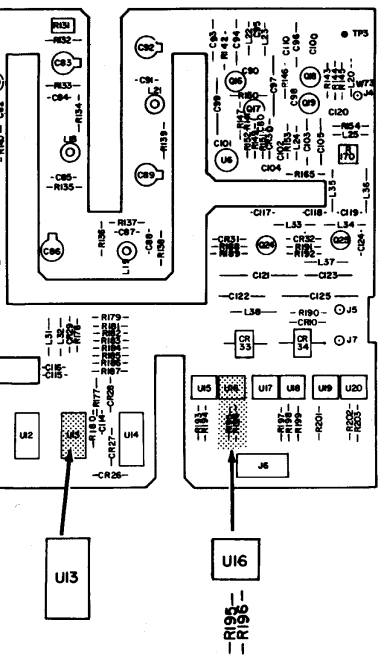
Preliminary Checks (All Relay Problems):

Instru

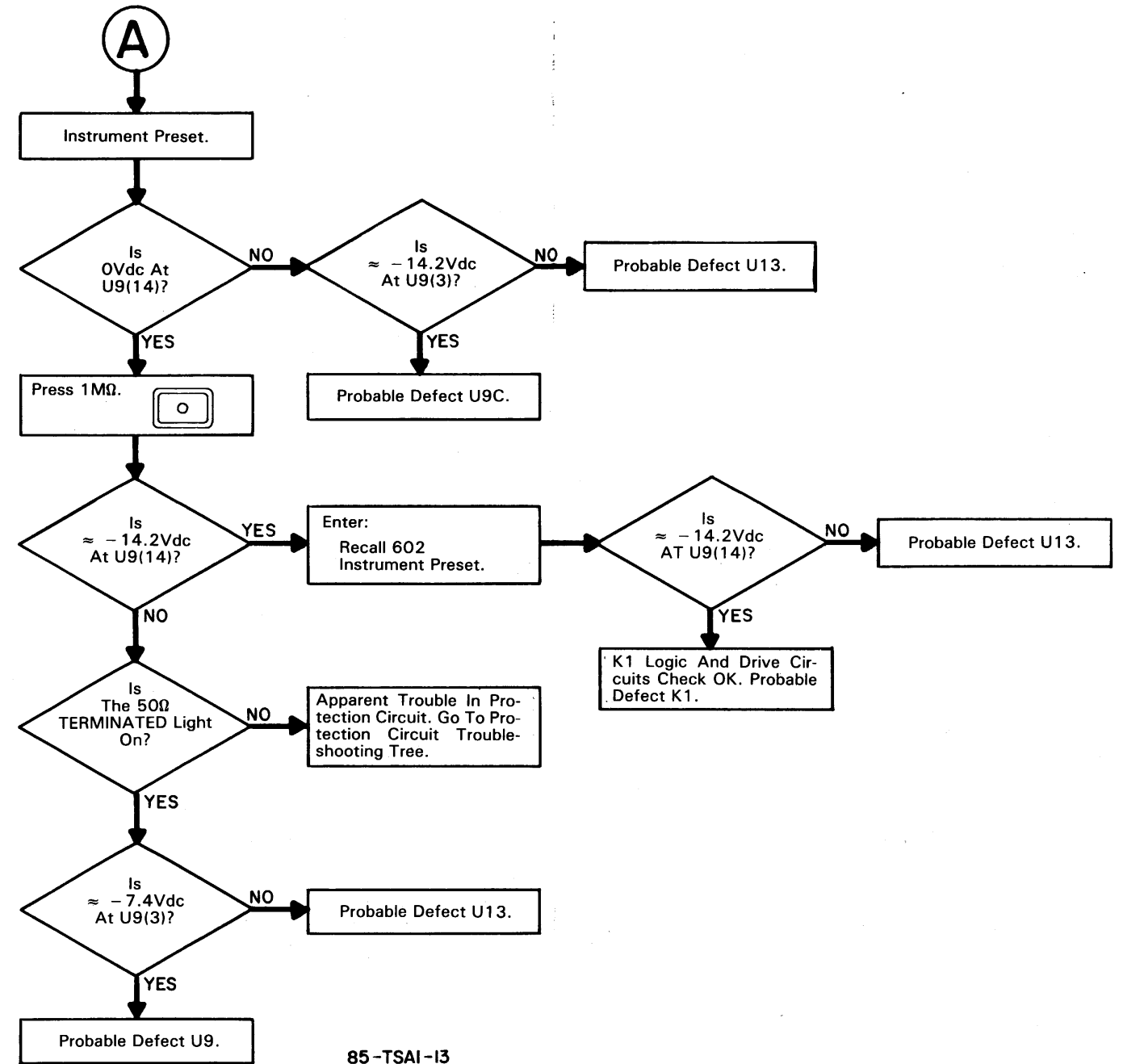
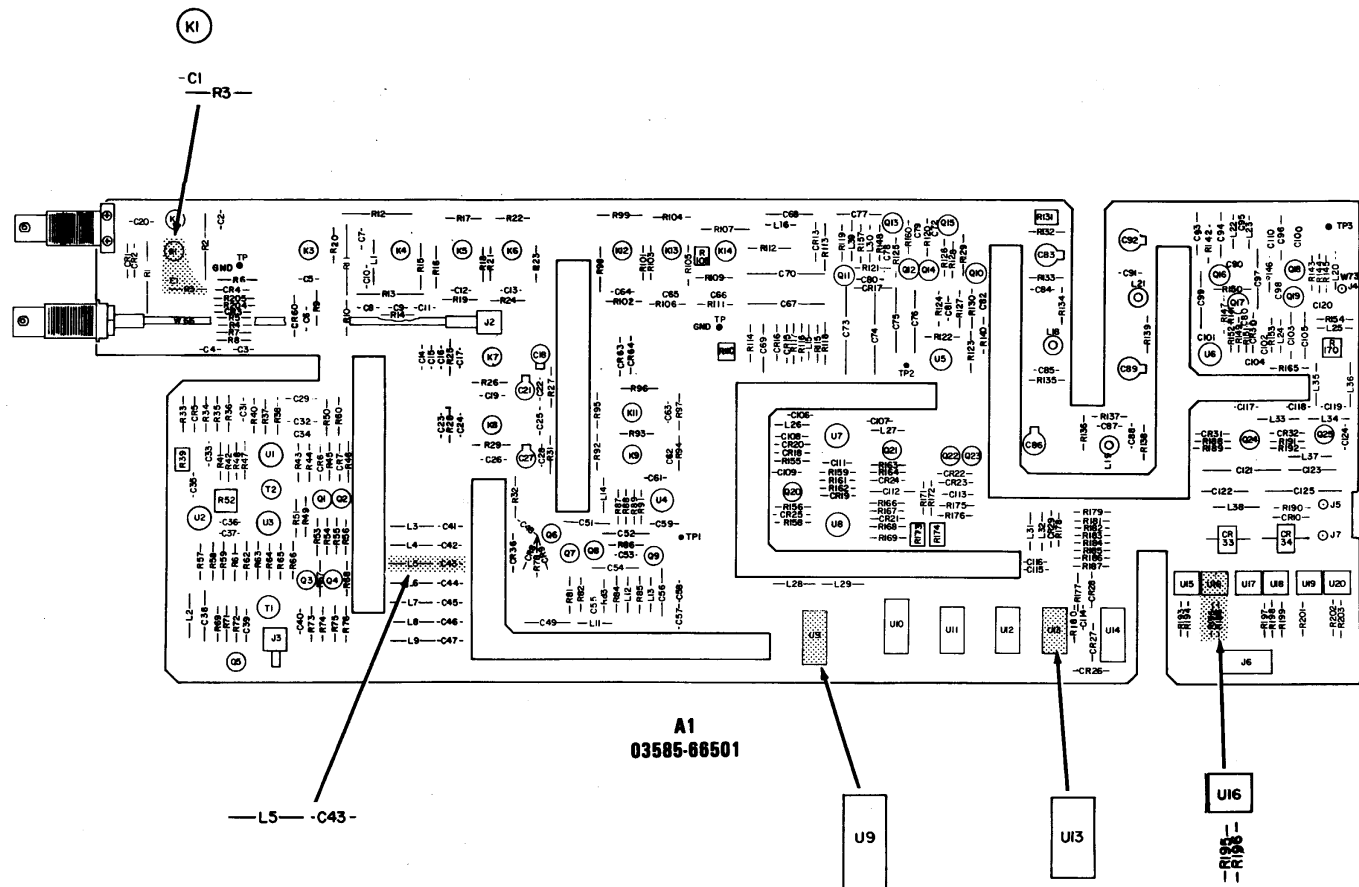


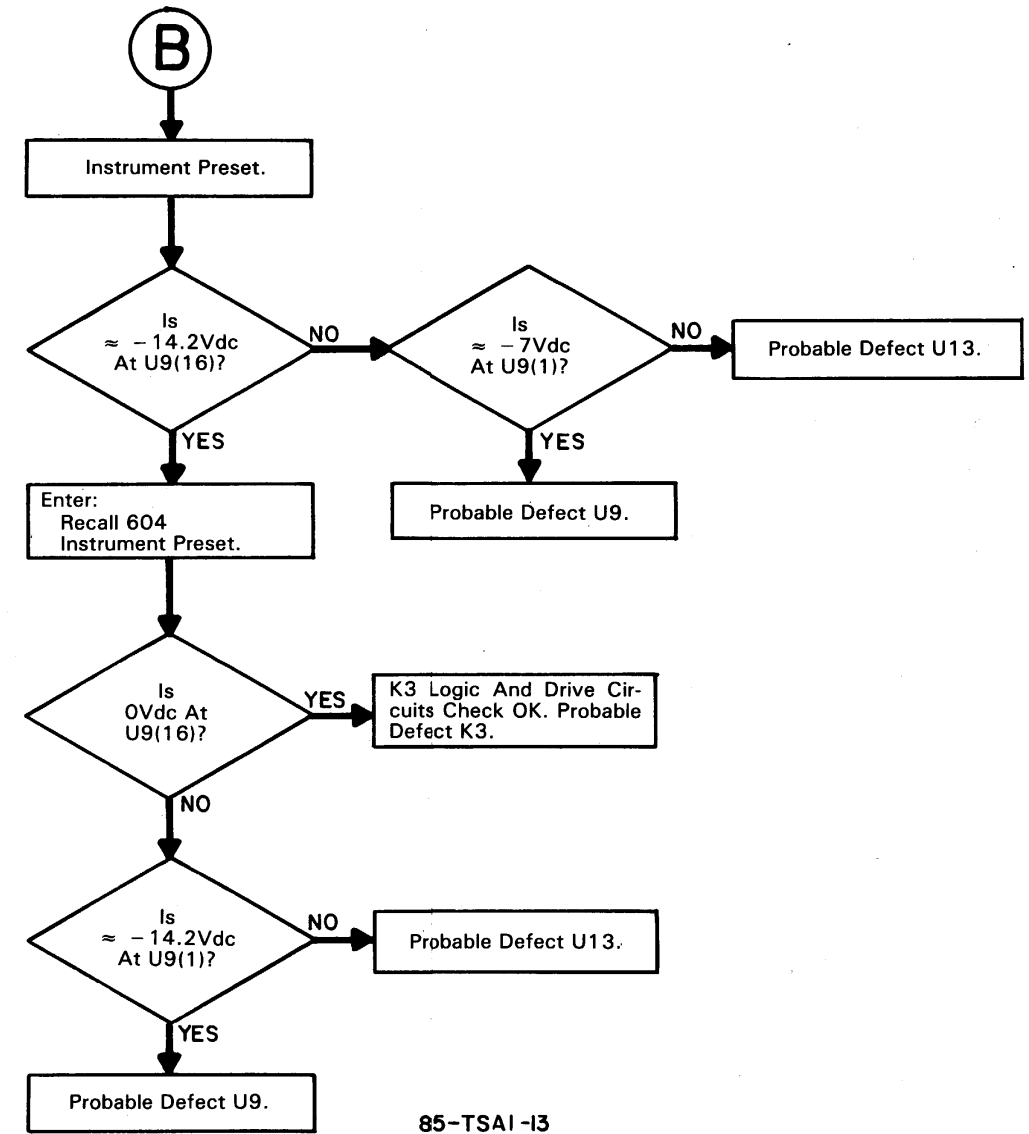
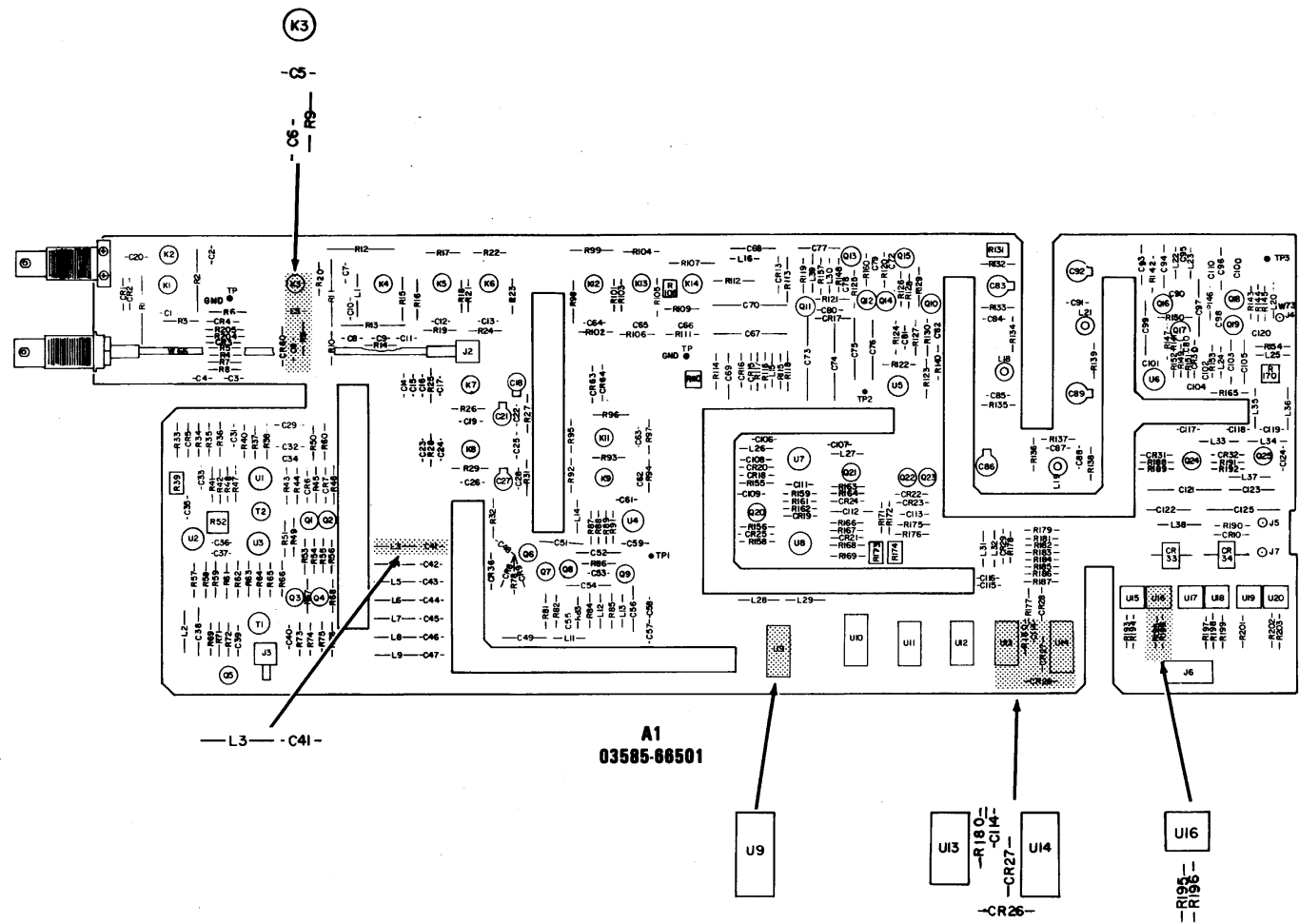
A1  
03585-66501

Preliminary Checks (All Relay Problems):

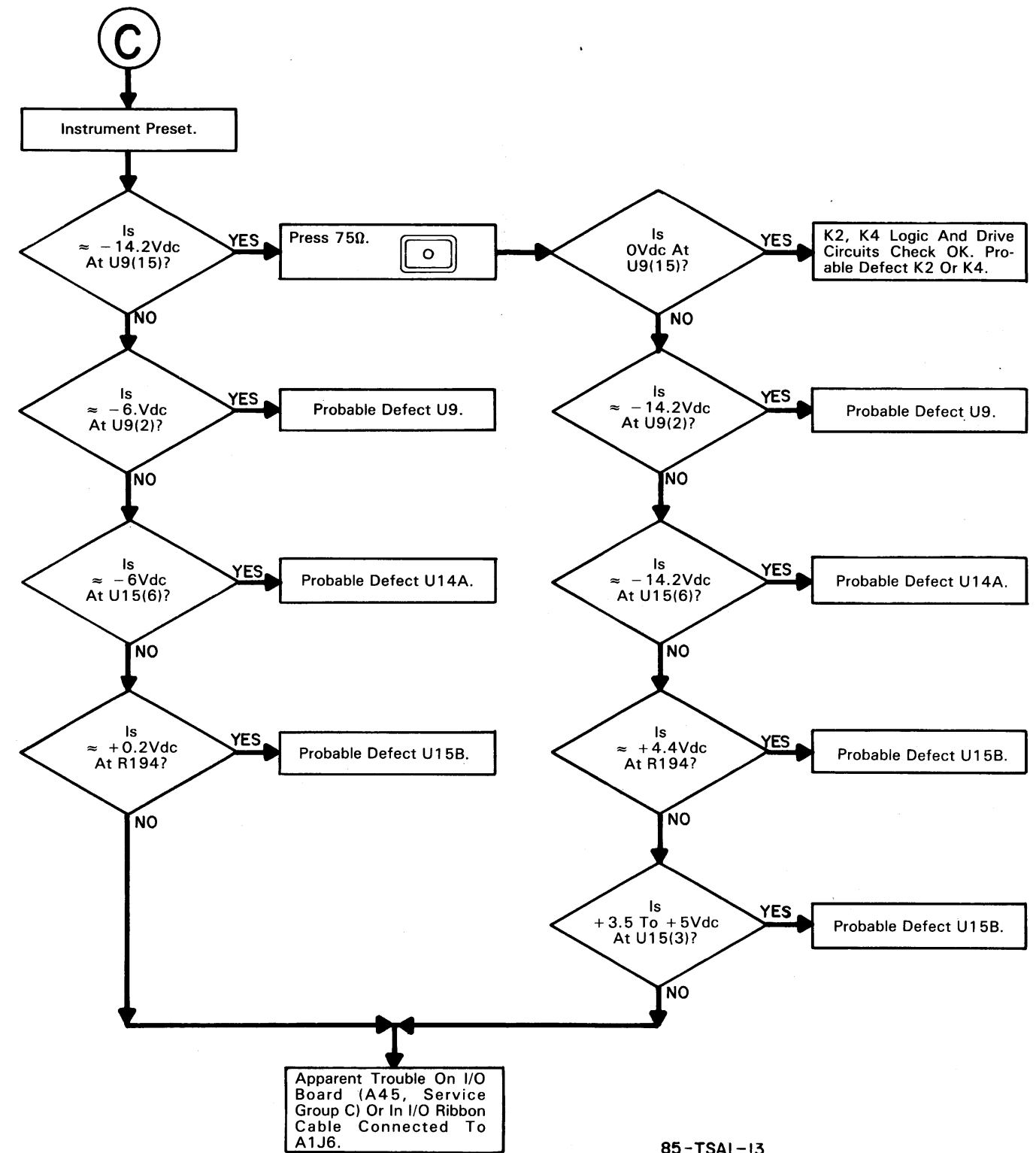
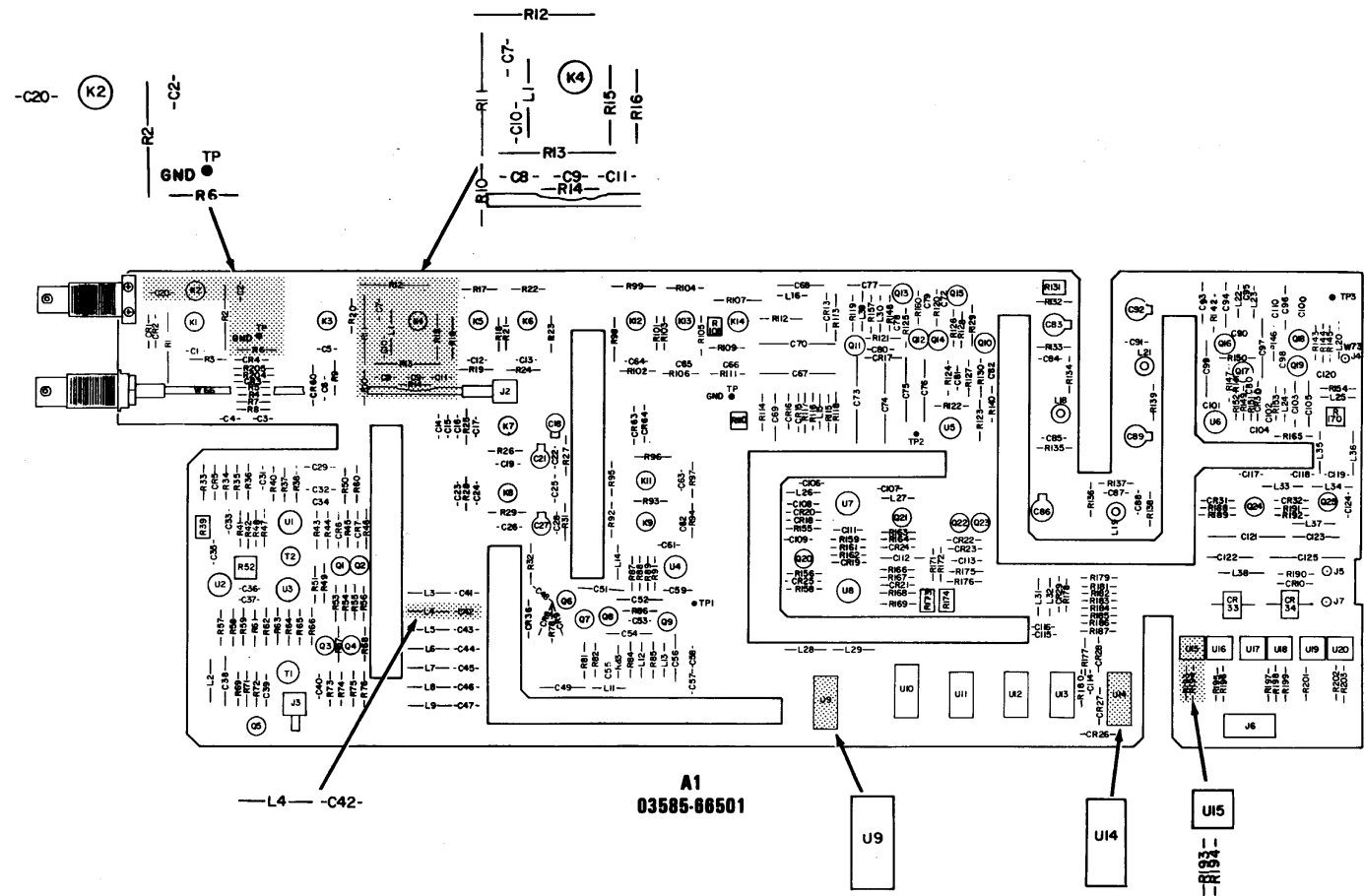


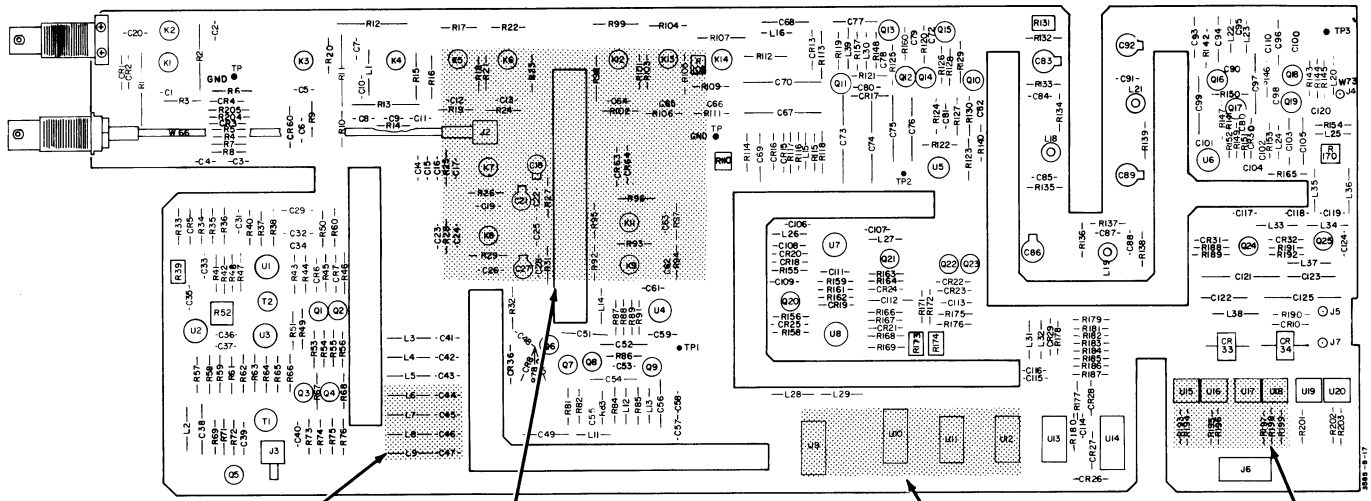






85-TSAI -13





A1  
03585-66501

- L6 — C44 —
- L7 — C45 —
- L8 — C46 —
- L9 — C47 —

- U9
- U10
- U11
- U12
- U15
- U16
- U17
- U18

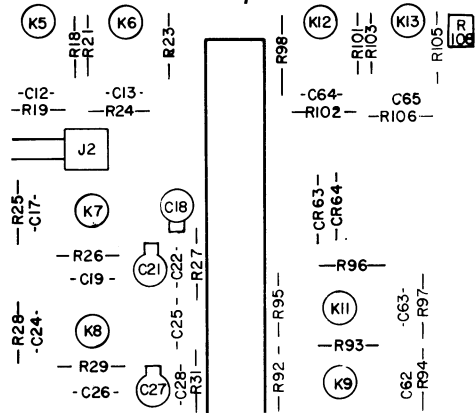


Table 1. Range Switching Troubleshooting Tree.

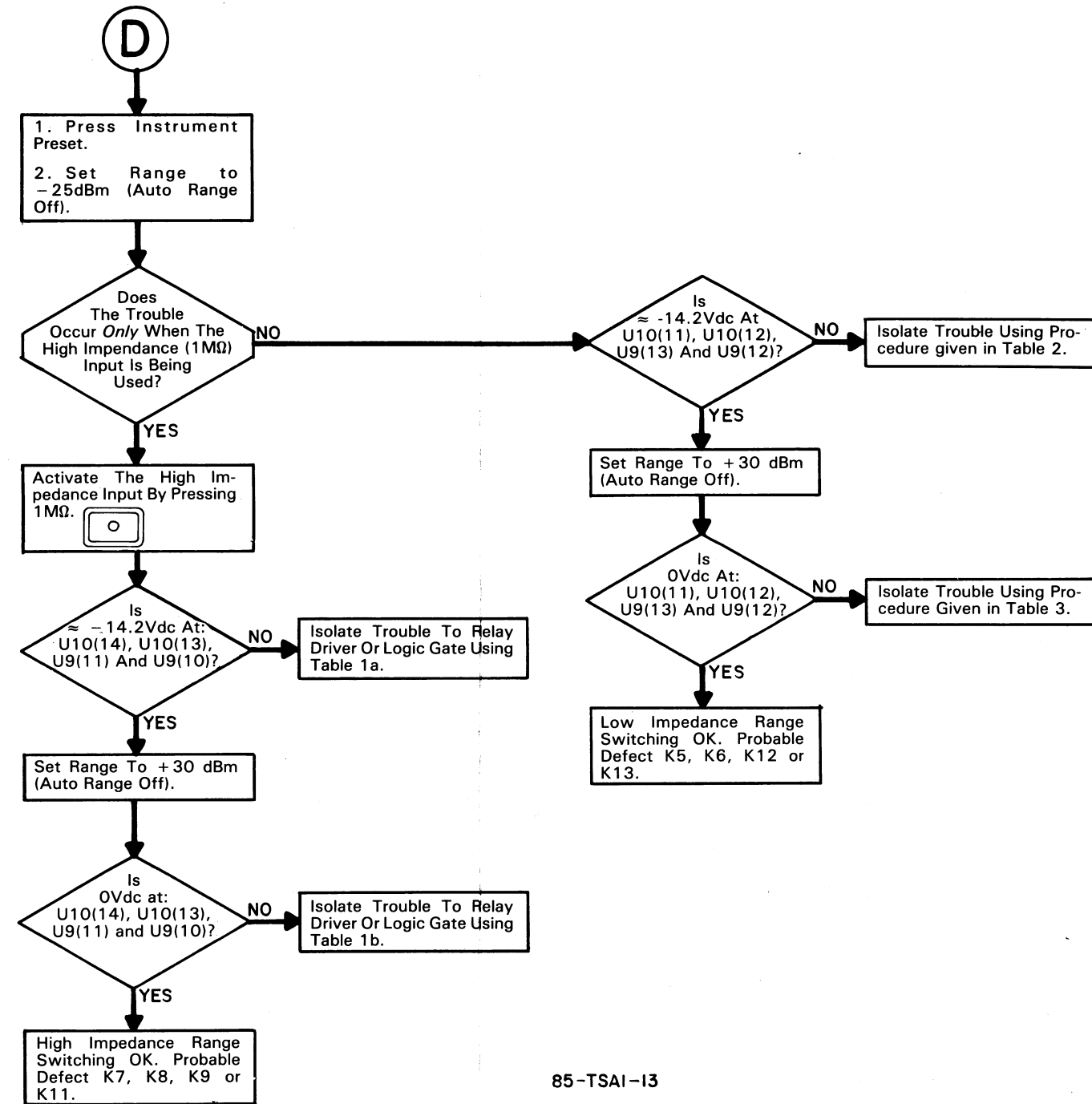
Hi Impedance Range Switching Checks -25dBm Range. Part A				
Checkpoint: Logic gate outputs; relay driver inputs.				
Relay:	K9	K11	K7	K8
Relay Driver:	U10(14)	U10(13)	U9(11)	U9(10)
Check for -7.3Vdc (nominal) at:	U11(11)	U11(10)	U12(11)	U12(10)
If <i>incorrect</i> , probable defect is logic gate having incorrect output; i.e., U11 or U12.				
If <i>correct</i> , probable defect is associated relay driver; i.e., U10 or U9.				
Hi Impedance Range Switching Checks +30dBm Range. Part B				
Checkpoint: Logic gate outputs; relay driver inputs.				
Relay:	K9	K11	K7	K8
Relay Driver:	U10(14)	U10(13)	U9(11)	U9(10)
Check for -14.8Vdc (nominal) at:	U11(11)	U11(10)	U12(11)	U12(10)
If <i>incorrect</i> , probable defect is logic gate having incorrect output; i.e., U11 or U12.				
If <i>correct</i> , probable defect is associated relay driver; i.e., U10 or U9.				

Table 2. LO Impedance Range Switching -25dBm Range.

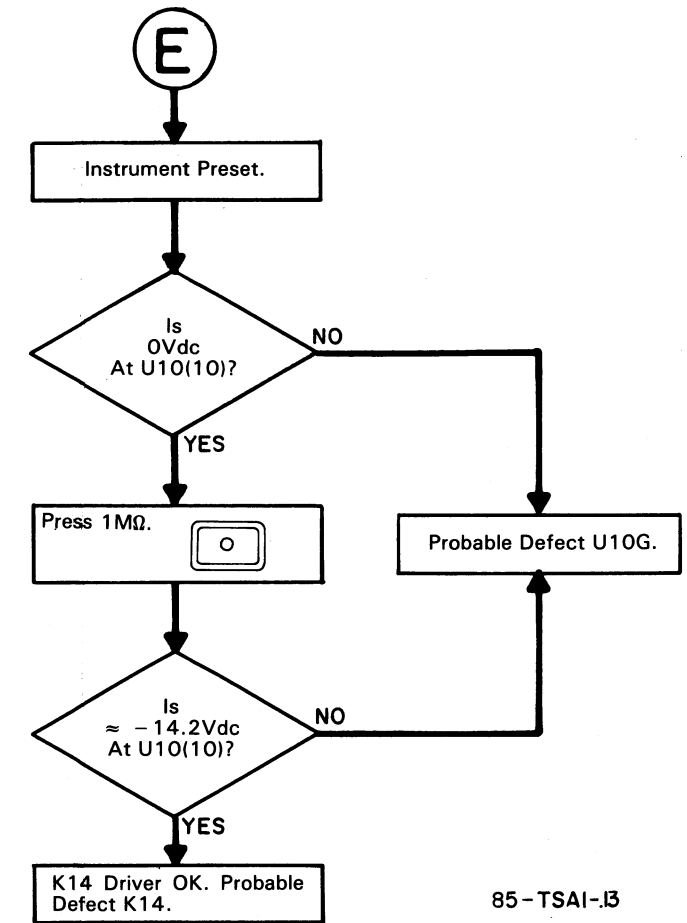
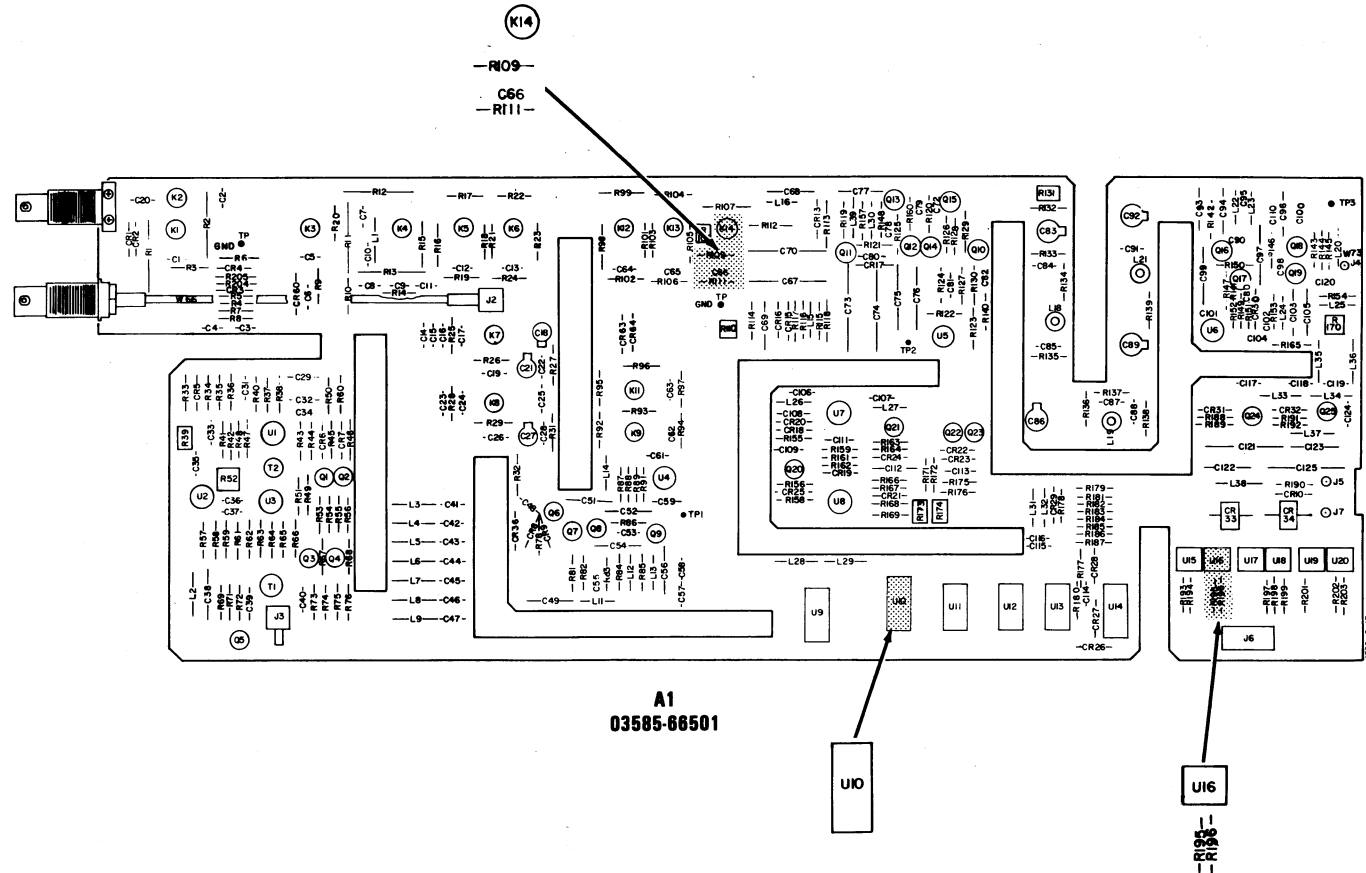
Checkpoint: Logic gate outputs; relay driver inputs.				
Relay:	K13	K12	K5	K6
Relay Driver:	U10(11)	U10(12)	U9(13)	U9(12)
a. Check for -7.3Vdc (nominal) at:	U11( 4)	U11( 3)	U12( 4)	U12( 3)
If <i>incorrect</i> , go to Step b.				
If <i>correct</i> , probable defect is associated Relay Driver; i.e., U10 or U11.				
Checkpoint: Optical isolator outputs; logic gate inputs.				
b. Check for -14Vdc (nominal) at:	U17( 6)	U18( 6)	U15( 7)	U17( 7)
If <i>incorrect</i> , go to Step c.				
If <i>correct</i> , probable defect is logic gate having incorrect output in Step a.				
Checkpoint: Inputs from I/O to optical isolators.				
c. Check for +0.2Vdc (nominal) at:	R198	R199	R193	R197
If <i>incorrect</i> , trouble is on I/O Assembly (A45, Service Group C) or ribbon cable (W71) connected to A1J6.				
If <i>correct</i> , probable defect is optical isolator having incorrect output in Step b.				

Table 3. LO Impedance Range Switching +30dBm Range.

Checkpoint: Logic gate outputs; relay driver inputs.				
Relay:	K13	K12	K5	K6
Relay Driver:	U10(11)	U10(12)	U9(13)	U9(12)
a. Check for -14.8Vdc (nominal) at:	U11( 4)	U11( 3)	U12( 4)	U12( 3)
If <i>incorrect</i> , go to Step b.				
If <i>correct</i> , probable defect is associated Relay Driver; i.e., U10 or U11.				
Checkpoint: Optical isolator outputs; logic gate inputs				
b. Check for -6.Vdc (nominal) at:	U17( 6)	U18( 6)	U15( 7)	U17( 7)
If <i>incorrect</i> , go to Step c.				
If <i>correct</i> , probable defect is logic gate having incorrect output in Step a.				
Checkpoint: Inputs from I/O to optical isolators.				
c. Check for +4.4Vdc (nominal) at:	R198	R199	R193	R197
If <i>incorrect</i> , trouble is on I/O Assembly (A45, Service Group C); I/O ribbon cable W71 connected to A1J6; or <i>open Optical Isolator</i> .				
If <i>correct</i> , probable defect is optical isolator having incorrect output in Step b.				



85-TSAI-13



85-TSAI-13

# SERVICE GROUP A-2 CONVERSION SECTION

**Board No's. A2,3,4,5**

**Part No. 03585-66502 Thru 03585-66505**

**INDEX:**

Title	Page
Input/Conversion Section Removal.....	11-77/11-78
Main Conversion Section Troubleshooting Tree.....	11-79/11-80

**ADJUSTMENTS:**

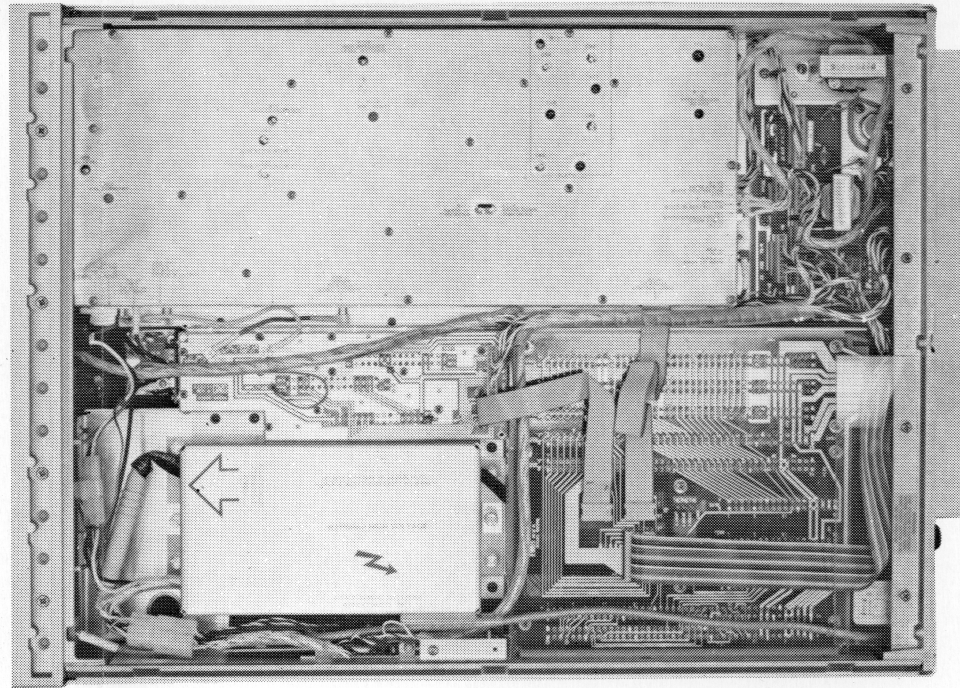
Component	Adjusted Parameter	Paragraph Location
A2L7,8,11,12	100.35MHz Passband Filter	5-33
A3L2	79.65MHz Image Filter	5-33
A3C8	79.65MHz Image Filter	5-33
A3L1,3,5,7	100.35MHz Passband Filter	5-33
A4L7	10.35MHz Passband Filter	5-33
A5L2,4,6	10.35MHz Passband Filter	5-33
A5L1,3,5	9.65MHz Image Filter	5-33

**TROUBLESHOOTING NOTES:**

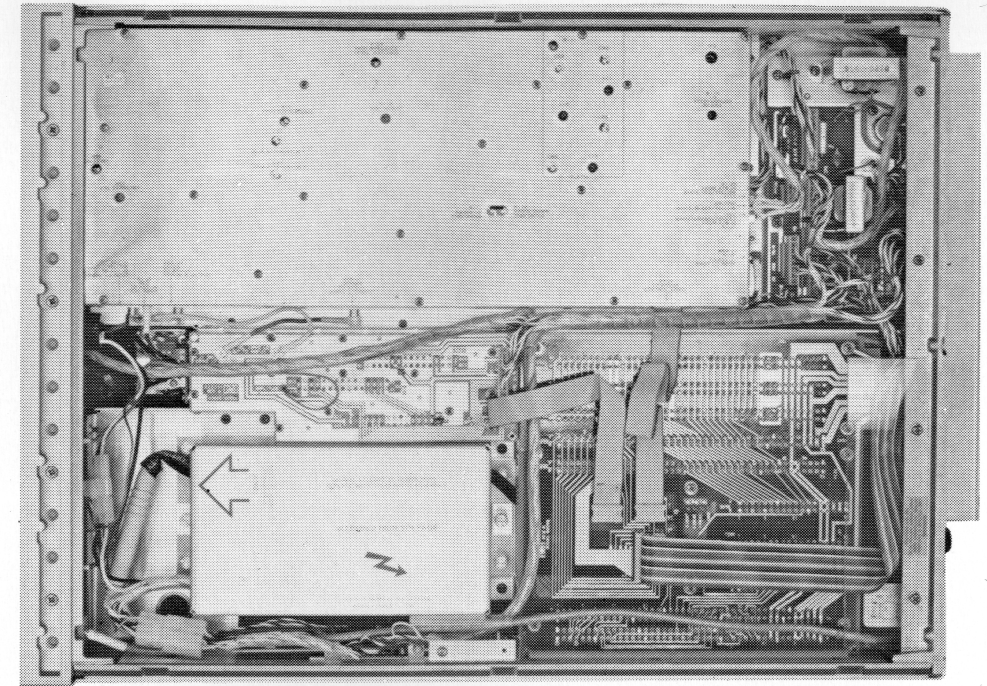
1. All levels shown in the troubleshooting tree or on the schematic were measured with the Model 10020A probe with the 20:1, 1K $\Omega$  tip installed. The usage of this probe is essential if repeatable readings are to be obtained.
2. Signal levels shown are typical values  $\pm 3$ dB. Conversion Section problems usually occur when signal levels are too low.
3. Signals entering opposing pins on the diode quad mixers should have equal amplitudes  $\pm 2$ dB. Imbalances indicate a possible input or output transformer problem if the transformer input signals are equal.

**INPUT/CONVERSION SECTION REMOVAL.**

- a. Set the 3585A LINE Switch to off.
- b. Place the instrument on its left side.
- c. Remove the bottom cover.
- d. Remove the following cables.



- f. Remove the seven mounting screws.



- e. Place a stack of books, approximately eight inches high, next to the instrument. These books will be used to support the Input/Conversion Section.

- g. The Input/Conversion Section of the instrument is now free. If necessary the covers may be removed. To work on the Conversion Section, place the Input/Conversion box as shown in the photo on the left. To work on the Input Section, place the Input/Conversion box as shown in the photo on the right. Reconnect all cables for proper operation after positioning the Input/Conversion box.

**WARNING**

*Use caution when working near the High Voltage portion of the instrument.*

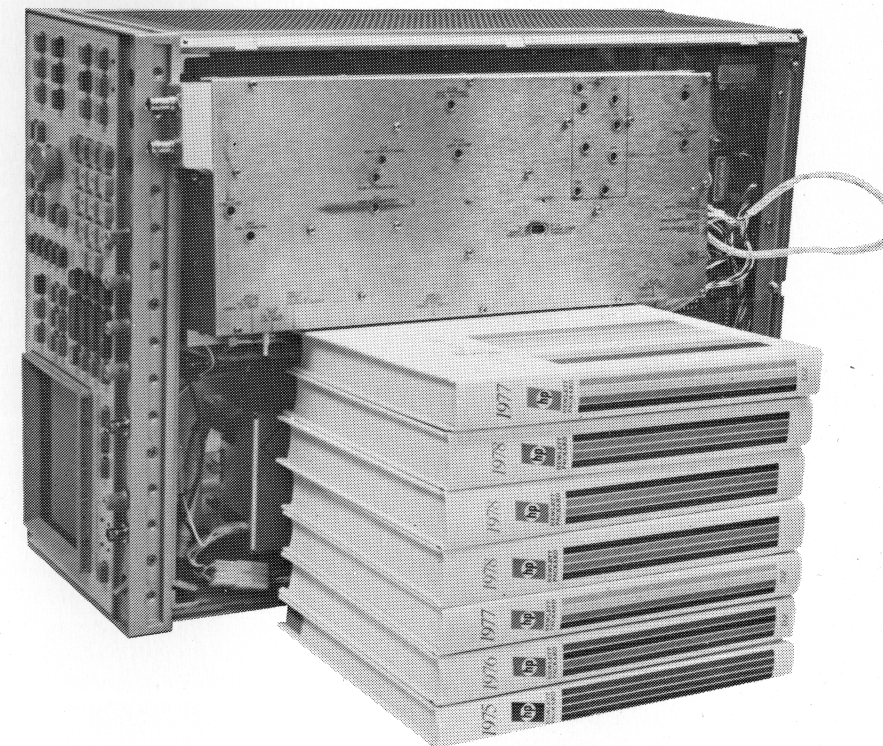
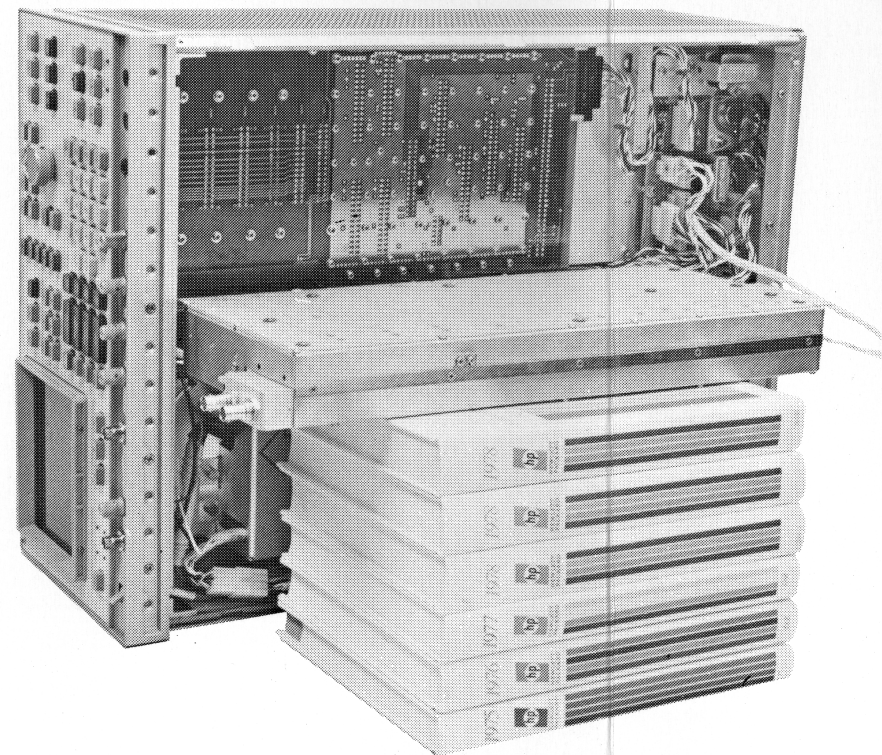
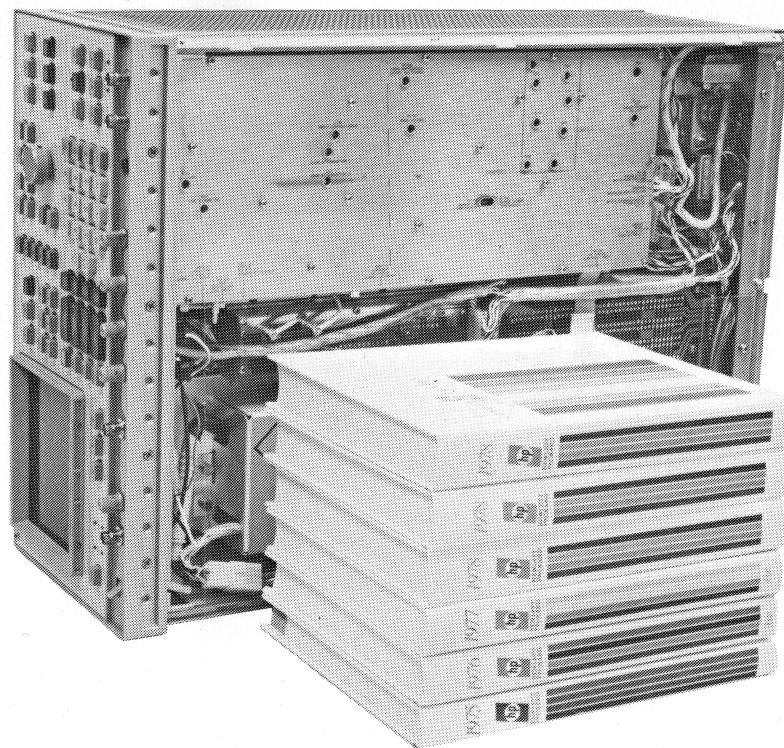
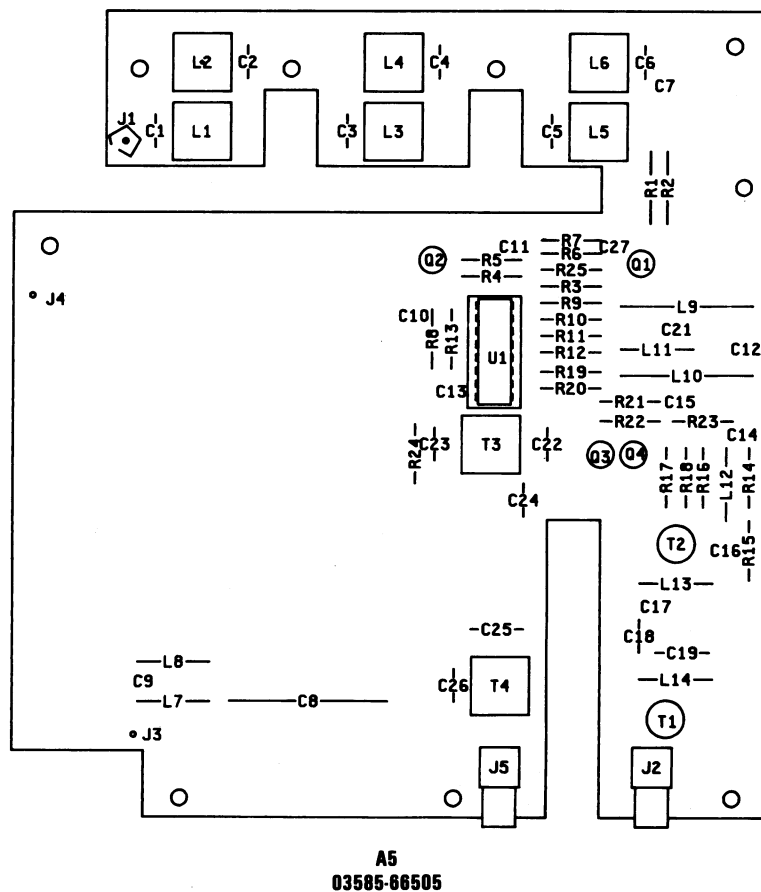
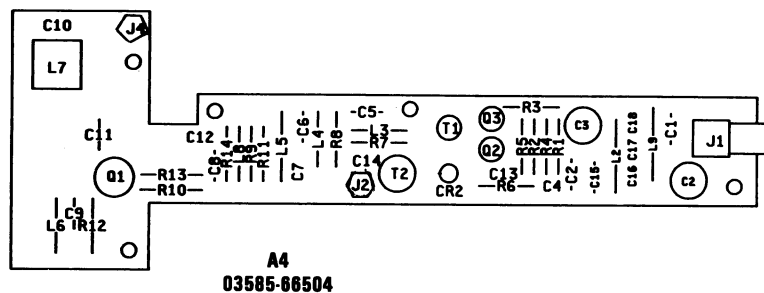
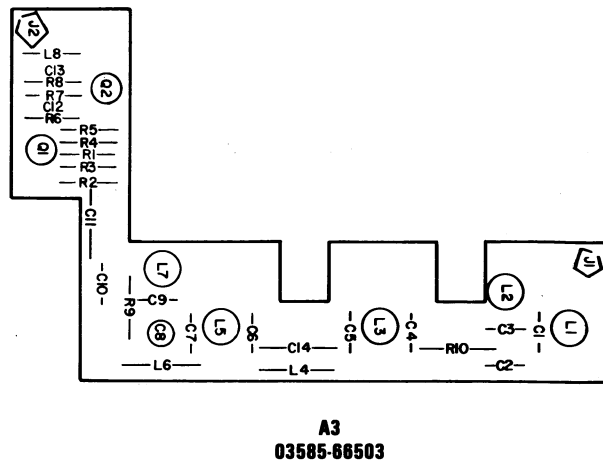
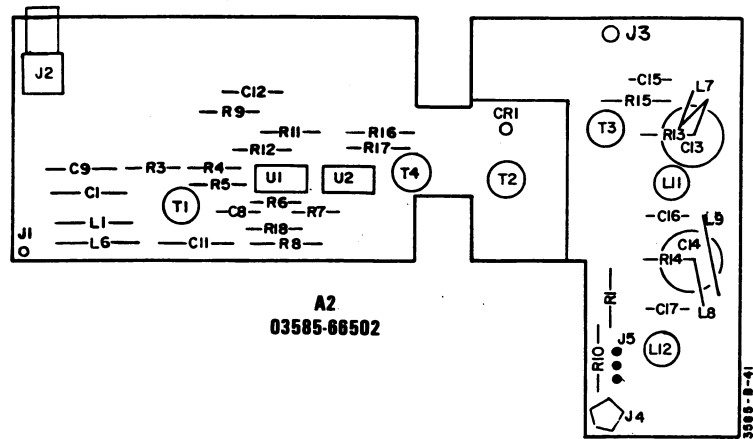


Figure 11-A-2-1. Input/Conversion Section Removal  
11-77/11-78





1. Before beginning these tests the spectrum analyzer (8558) should be calibrated as follows:

Set the synthesizer for 5MHz, 0dBm.

Set the 8558 controls for:

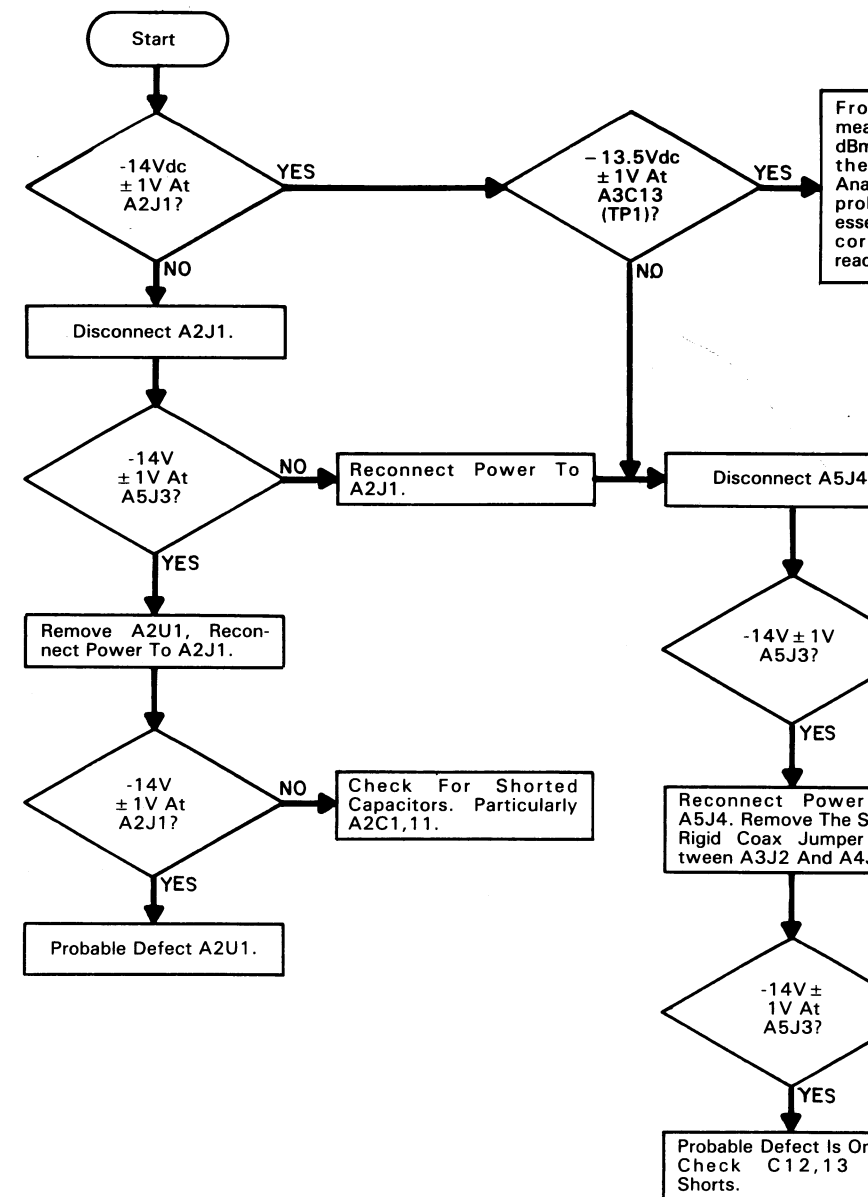
Freq Span 5MHz/Div  
Reference Level -26dBm  
Attenuator -30dB

2. Connect the 20:1 1KΩ probe to the 8558's 50Ω input. Touch the probe tip to the synthesizer's output. Be sure the probe is grounded to the synthesizer.

3. A 5MHz, -26dBm response should appear on screen. It may be necessary to adjust the Reference Level so that the signal is at the top graticule line. Record any deviation from -26dBm and add it to all your readings during these tests.

**NOTE**

It may be necessary to repeat this procedure during the course of these tests due to the internal amplitude drift of the 8558.



1. Before beginning these tests the spectrum analyzer (8558) should be calibrated as follows:

Set the synthesizer for 5MHz, 0dBm.

Set the 8558 controls for:

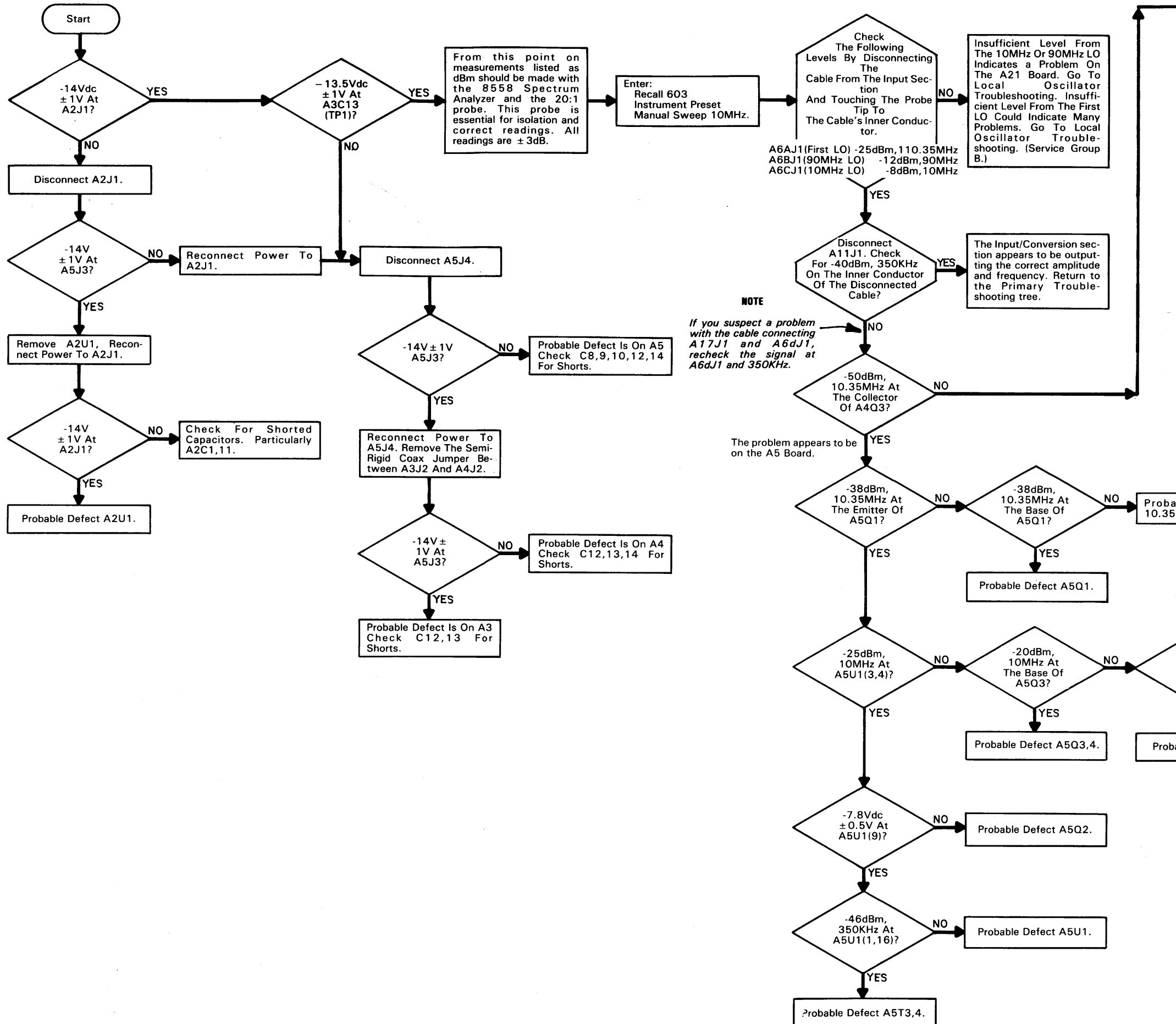
Freq Span 5MHz/Div  
Reference Level -26dBm  
Attenuator -30dB

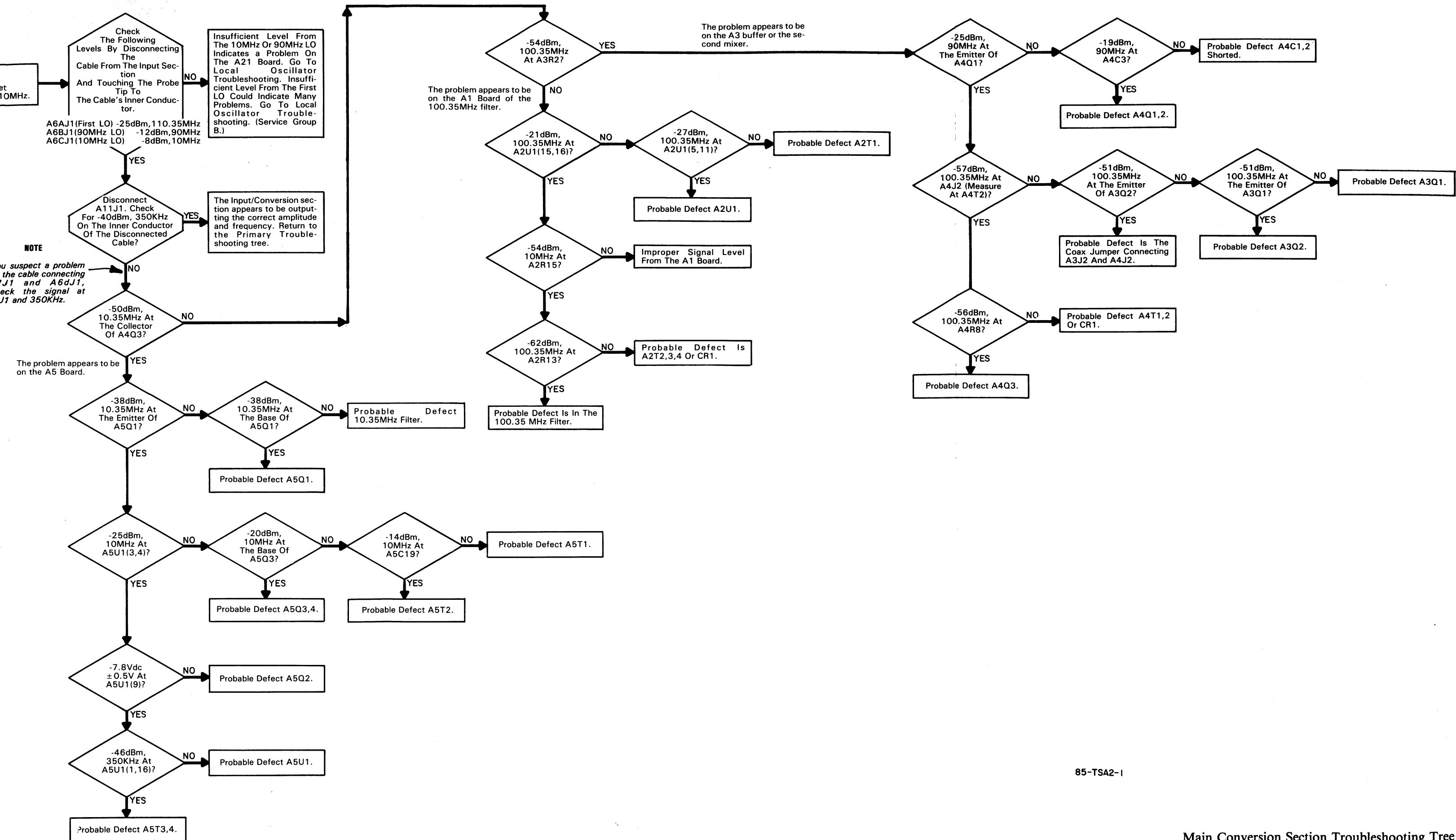
2. Connect the 20:1 1KΩ probe to the 8558's 50Ω input. Touch the probe tip to the synthesizer's output. Be sure the probe is grounded to the synthesizer.

3. A 5MHz, -26dBm response should appear on screen. It may be necessary to adjust the Reference Level so that the signal is at the top graticule line. Record any deviation from -26dBm and add it to all your readings during these tests.

**NOTE**

It may be necessary to repeat this procedure during the course of these tests due to the internal amplitude drift of the 8558.





85-TSA2-1

# SERVICE GROUP A-3

## FINAL IF SECTION

Board No's A17, 18 AND 19

Part Number 03585-66517 Thru 03585-66519

### INDEX:

Title	Page
Final IF (A17-19) Troubleshooting Tree.....	11-87/11-88
A17-19 30KHz BW Main Signal Path Troubleshooting Tree.....	11-89/11-90
A17-19 LC BW Main Signal Path Troubleshooting Tree.....	11-91/11-92
A17-19 Crystal BW Main Signal Path Troubleshooting Tree.....	11-93/11-94
A17 LC BW Switching Troubleshooting Tree.....	11-95/11-96
A18 LC BW Switching Troubleshooting Tree.....	11-97/11-98
A19 LC BW Switching Troubleshooting Tree.....	11-99/11-100
A17 Crystal BW Switching Troubleshooting Tree.....	11-101/11-102
A18 Crystal BW Switching Troubleshooting Tree.....	11-103/11-104
A19 Crystal BW Switching Troubleshooting Tree.....	11-105/11-106
IF Attenuator Troubleshooting Tree.....	11-107/11-108
A17 FET Switch Truth Table.....	11-109
A18 FET Switch Truth Table.....	11-109
A19 FET Switch Truth Table.....	11-110
Test Procedure For IF Filters.....	11-110
Test Procedure For An Individual IF Stage.....	11-111
A17-A19 Board Signature Analysis Tests.....	11-112
Crystal Replacement Procedure.....	11-117

### ADJUSTMENTS:

Component	Adjusted Parameter	Paragraph Location
A17R105	IF Input Level	5-39
A17L4	LC First Stage Center Frequency	5-30
A17R12	LC First Stage Insertion Loss	5-30
A17L5	LC Second Stage Center Frequency	5-29
A17R20	LC Second Stage Insertion Loss	5-29
A17L6	XTAL First Stage Center Frequency	5-28
A17C29	XTAL First Stage Symmetry	5-28
A17L8	XTAL First And Second Stage Amplitude	5-28
A17L7	XTAL Second Stage Center Frequency	5-27
A17C39	XTAL Second Stage Symmetry	5-27
A17C27	XTAL 1, 3Hz Center Frequency	5-31
A17C37	XTAL 2, 3Hz Center Frequency	5-31
A17R26	300Hz Res. BW Gain	5-31
A17R28	100Hz Res. BW Gain	5-31
A17R30	30Hz Res. BW Gain	5-31
A17R32	10Hz Res. BW Gain	5-31
A17R34	3Hz Res. BW Gain	5-31
A18L5	LC Third Stage Center Frequency	5-26
A18R15	LC Third Stage Insertion Loss	5-26
A18L4	XTAL Third Stage Center Frequency	5-25
A18C24	XTAL Third Stage Symmetry	5-25
A18L6	XTAL Third Stage Amplitude	5-25

Component	Adjusted Parameter	Paragraph Location
A18C22	XTAL 3, 3Hz Center Frequency	5-31
A18R77	First 16dB Gain Amplitude	5-31
A18R71	Second 16dB Gain Amplitude	5-31
A18R65	Third 16dB Gain Amplitude	5-31
A19L4	LC Fourth Stage Center Frequency	5-23
A19R20	LC Fourth Stage Insertion Loss	5-23
A19L5	LC Fifth Stage Center Frequency	5-24
A19R28	LC Fifth Stage Insertion Loss	5-24
A19L6	XTAL Fourth Stage Center Frequency	5-22
A19C30	XTAL Fourth Stage Symmetry	5-22
A19L7	XTAL Fifth Stage Center Frequency	5-21
A19C41	XTAL Fifth Stage Symmetry	5-21
A19C28	XTAL 4, 3Hz Center Frequency	5-31
A19C39	XTAL 5, 3Hz Center Frequency	5-31

**TROUBLESHOOTING NOTES:**

1. When you encounter the instruction

Enter: Res. BW      ↑      ↓

press the following keys:



This sequence of keys forces the instrument into the proper test mode.

2. Two things should be watched for during the tests:

- Correct signal amplitude
- Correct filter skirt width

3. Figures of the CRT are used extensively in this section to illustrate various steps in the procedure. The figures below should help you determine if a failure has occurred. Figure 11-A-3-11 shows the normal difference between two bandwidths. Figure 11-A-3-2,3,4 show what a true failure usually looks like.

4. If, after studying the figures, it is still unclear whether or not a true failure has occurred, use the Bandwidth Tests (Paragraph 4-83) to check the Resolution Bandwidth in question. If the Bandwidth in question passes the 3dB bandwidth and Shape Factor specifications continue with the troubleshooting procedure.

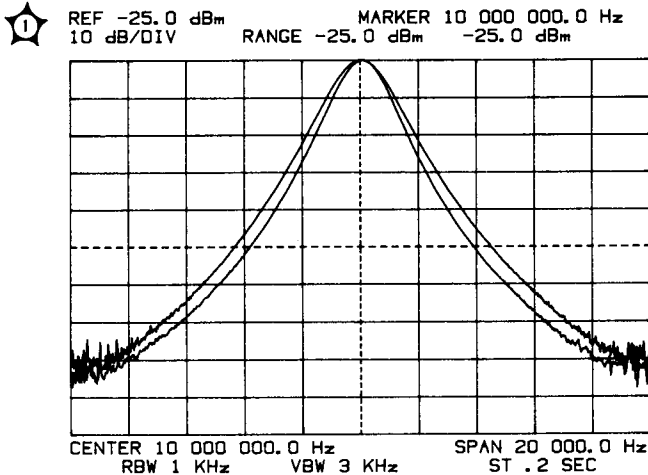
5. If one or more stages of IF filtering fail, the Shape Factor will increase according to the table below. To use the table, measure the Shape Factor of the instrument. If the result is equal ( $\pm 10\%$ ) to one of the numbers in the table it is an indication that one of the IF filter stages has failed.

**NOTE**

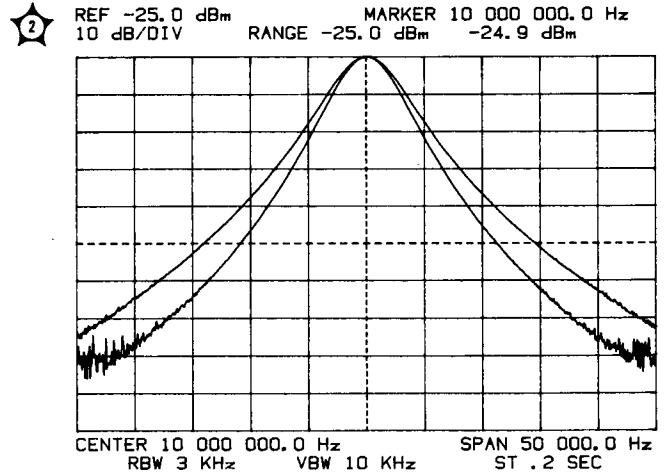
*This test is only a first order indication. The problem must be isolated to an individual board before a failure can be confirmed.*

	# Of Stages Operating				
	5	4	3	2	1
Shape Factor	10	11.3	13.2	16.7	25.9

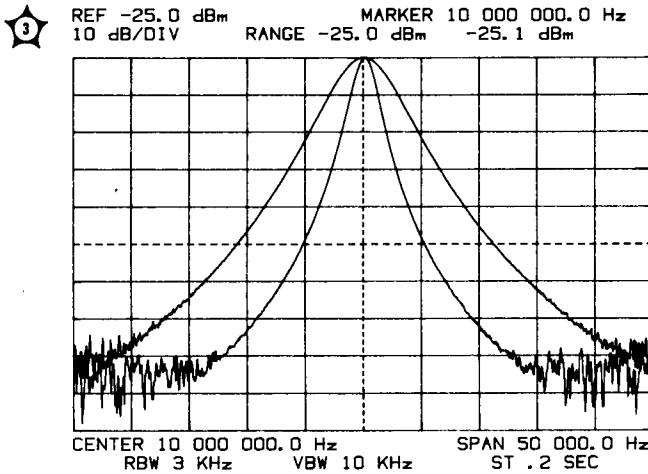
Shape Factor = 60dB Bandwidth/3dB Bandwidth



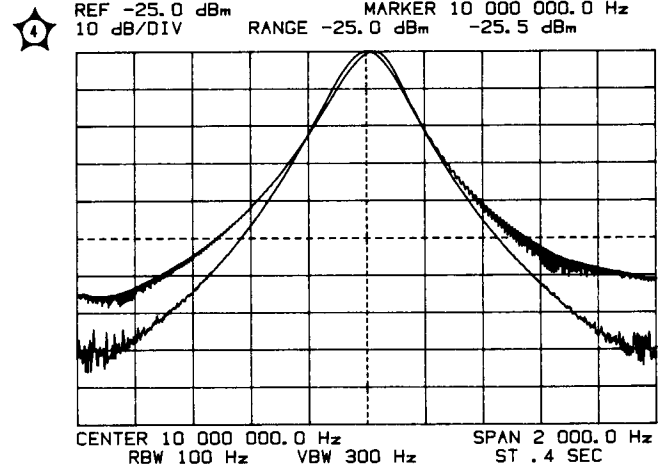
**Figure 11-A-3-1. Normal Display With Two Different Res. Bandwidths**



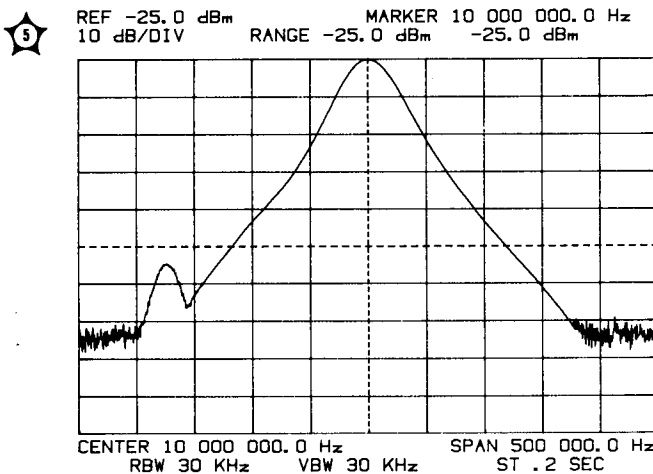
**Figure 11-A-3-2. Shape Factor Too Large**



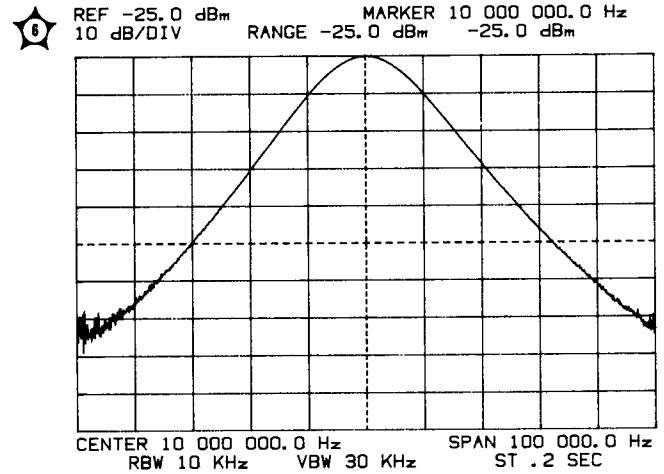
**Figure 11-A-3-3. Shape Factor Too Small**



**Figure 11-A-3-4. Shorted Crystal Stage**



**Figure 11-A-3-5. 30KHz Res. Bandwidth**



**Figure 11-A-3-6. 10KHz Res. Bandwidth**

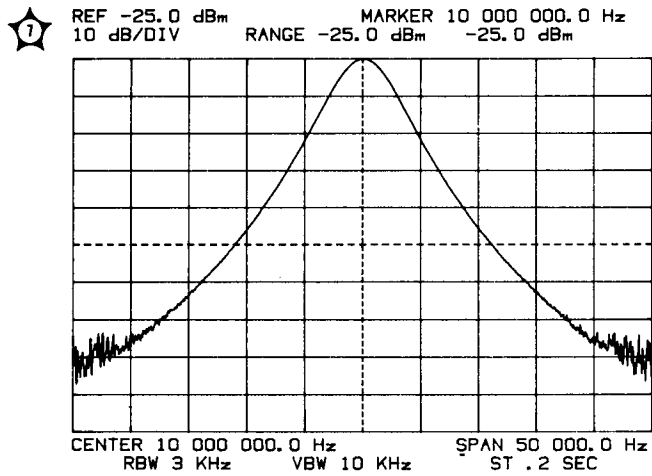


Figure 11-A-3-8. 1-3-10KHz Bandwidths, Two Filter Stages

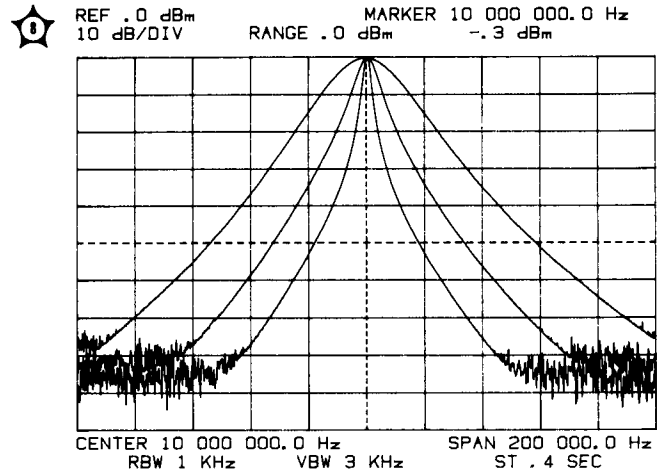


Figure 11-A-3-7. 3KHz Res. Bandwidth Reference Trace

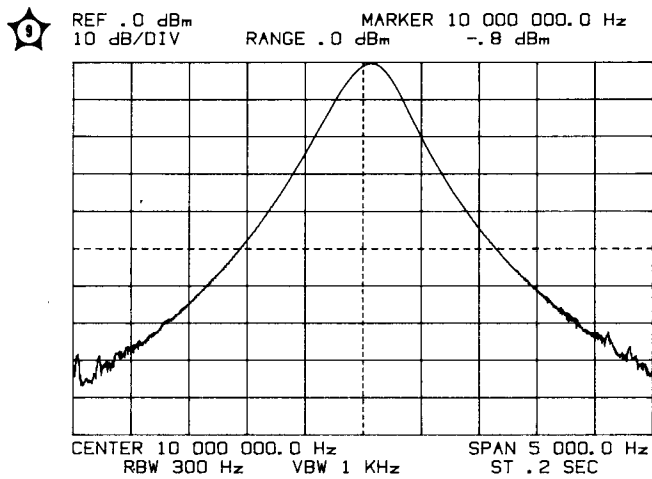


Figure 11-A-3-9. 300Hz Res. Bandwidth

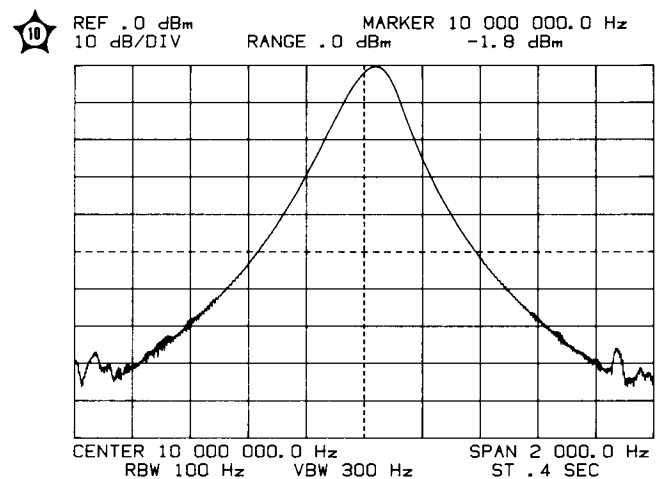


Figure 11-A-3-10. 100Hz Res. Bandwidth

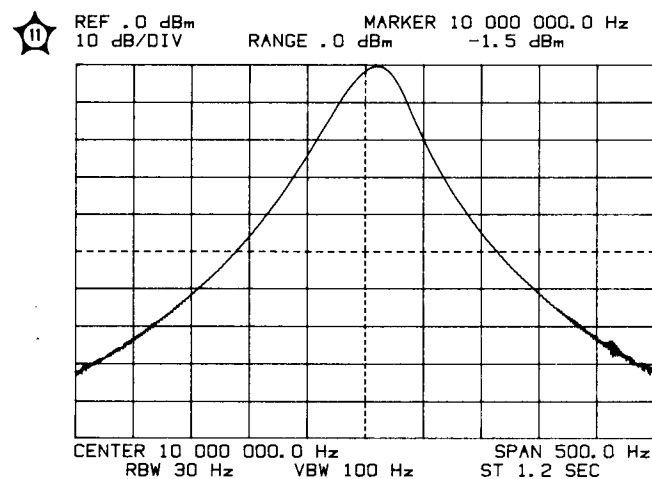


Figure 11-A-3-11. 30Hz Res. Bandwidth

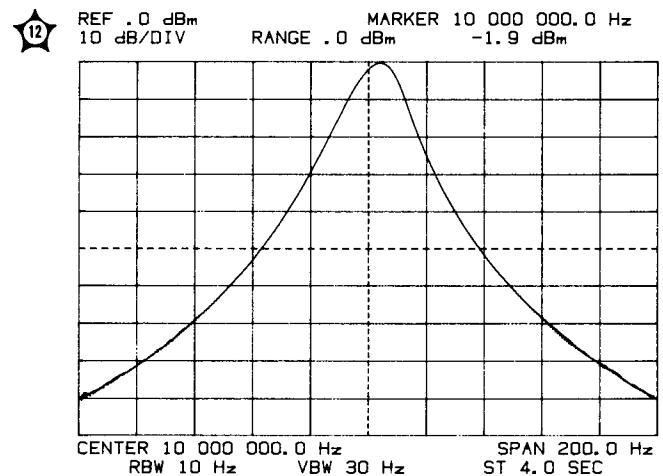


Figure 11-A-3-12. 10Hz Res. Bandwidth

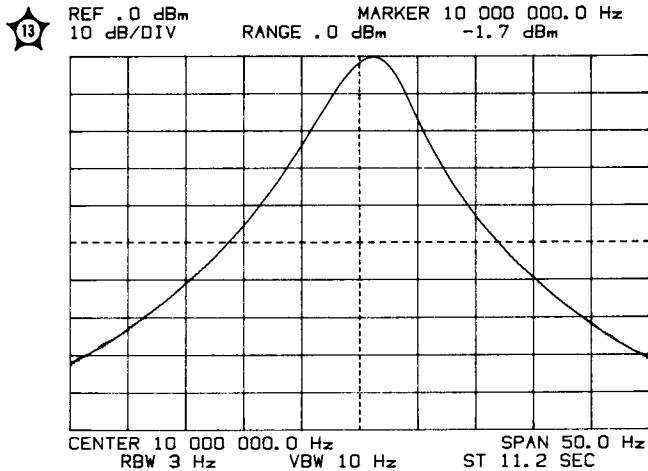


Figure 11-A-3-13. 3Hz Res. Bandwidth

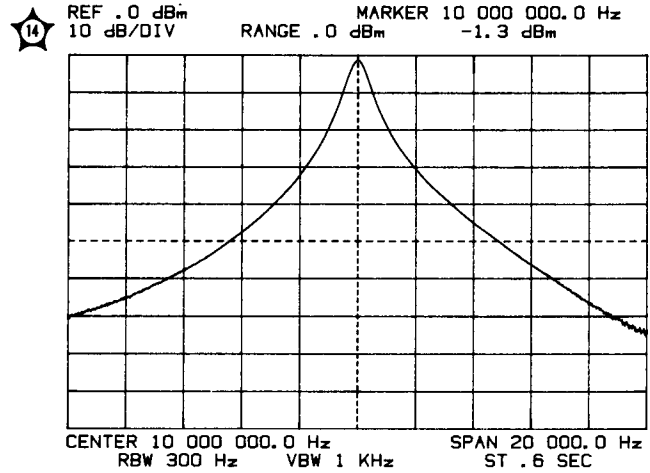


Figure 11-A-3-14. 300Hz Res. Bandwidth,  
Two Filter Stages

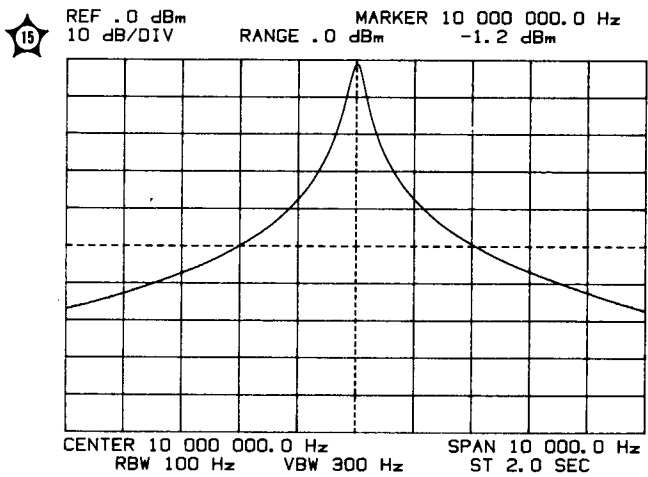


Figure 11-A-3-15. 100Hz Res. Bandwidth,  
Two Filter Stages

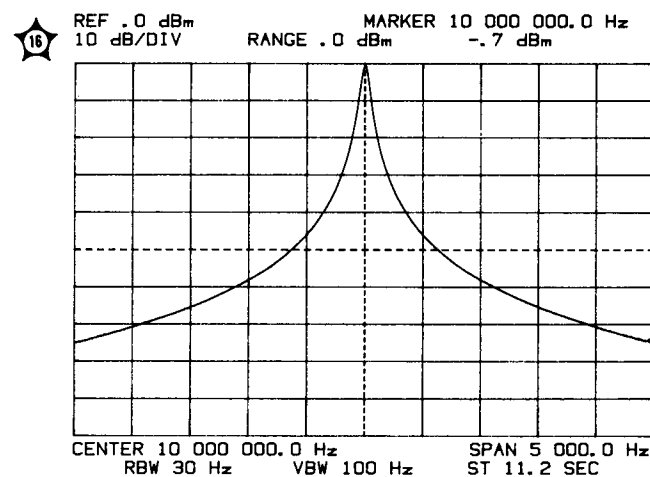


Figure 11-A-3-16. 30Hz Res. Bandwidth,  
Two Filter Stages

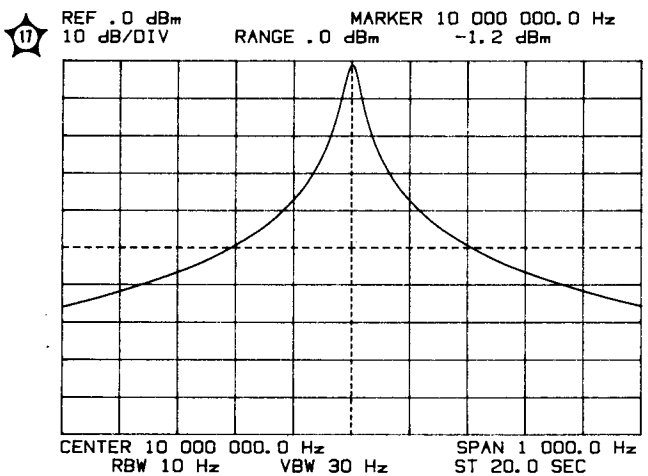


Figure 11-A-3-17. 10Hz Res. Bandwidth,  
Two Filter Stages

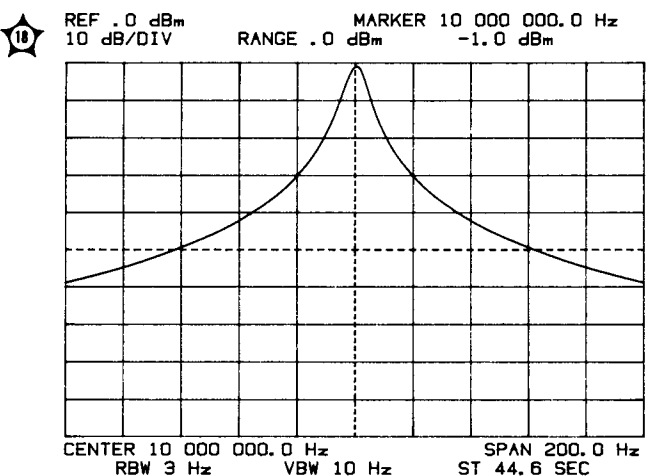
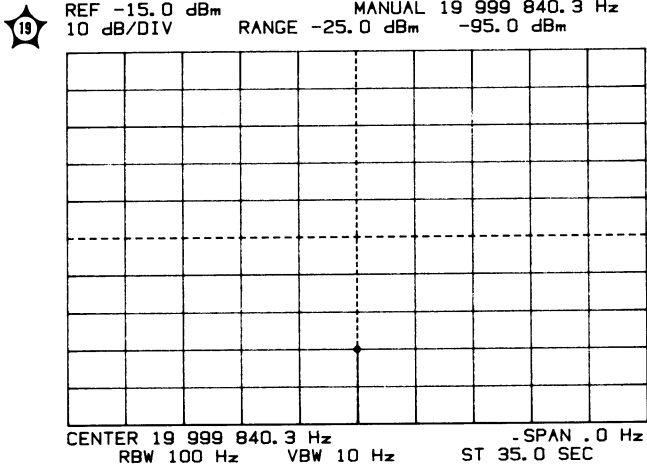
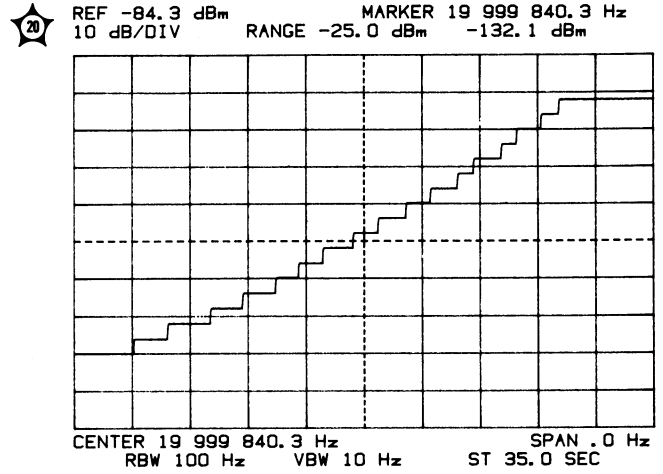


Figure 11-A-3-18. 3Hz Res. Bandwidth,  
Two Filter Stages

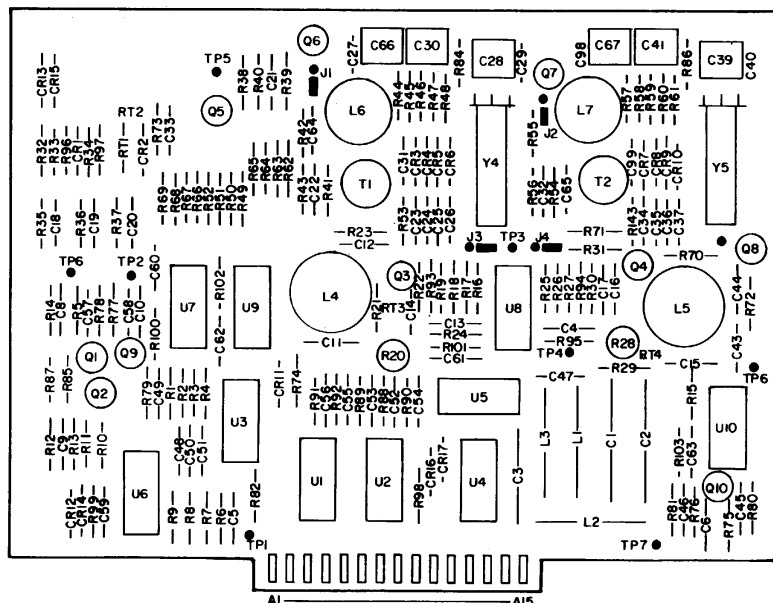




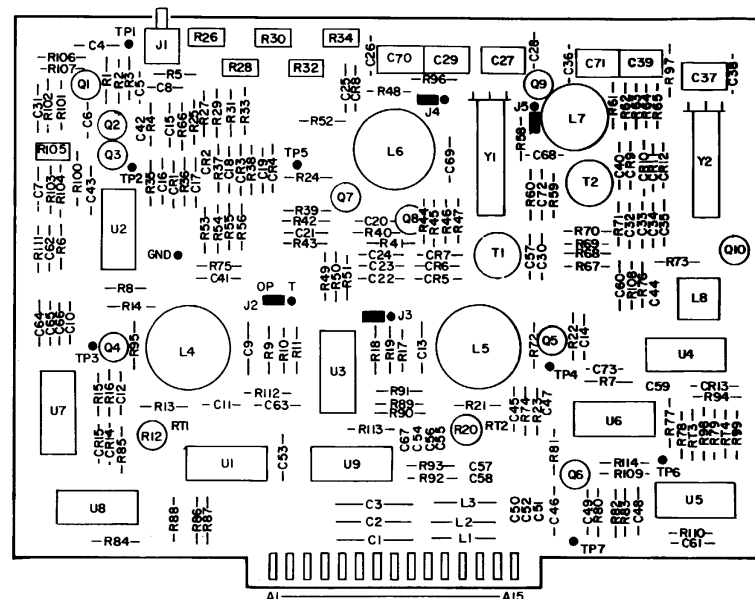
**Figure 11-A-3-19. IF Attenuator Test Set-up Display**



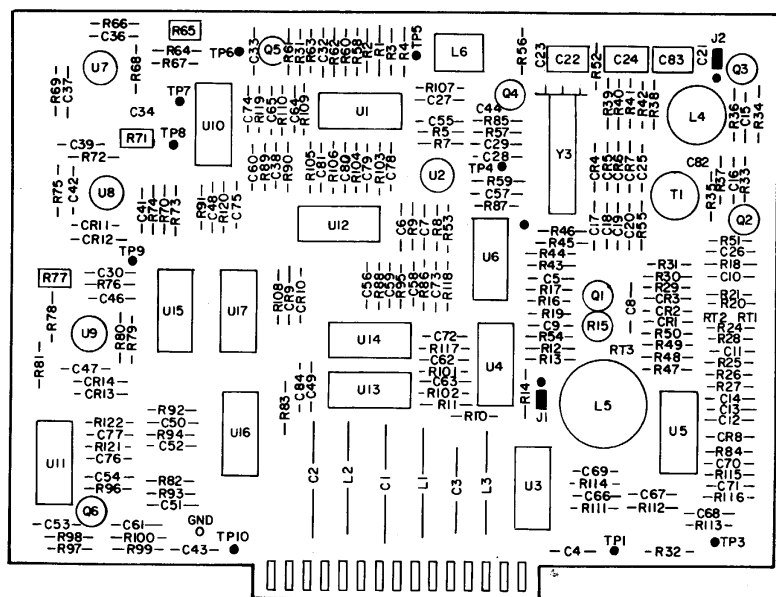
**Figure 11-A-3-20. Typical IF Attenuator Stairstep Response**



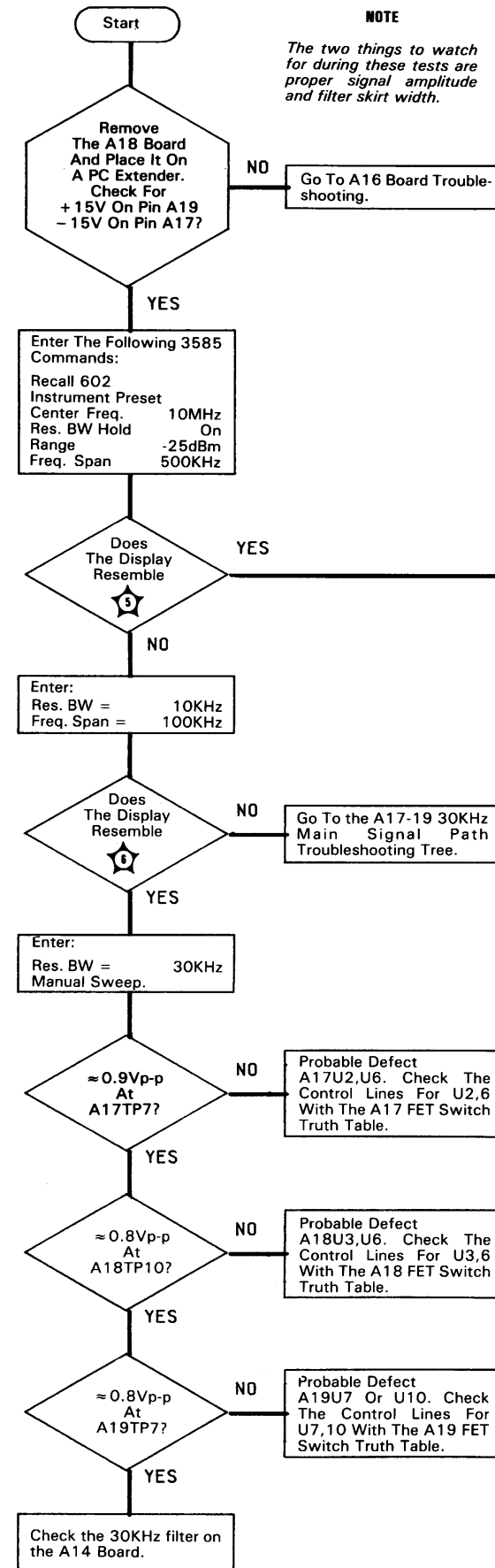
**A17**  
03585-66517



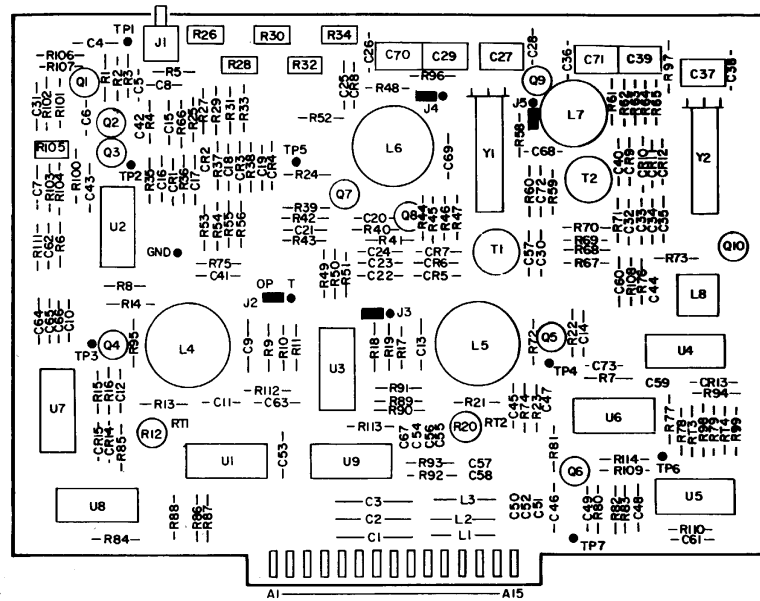
**A18**  
03585-66518



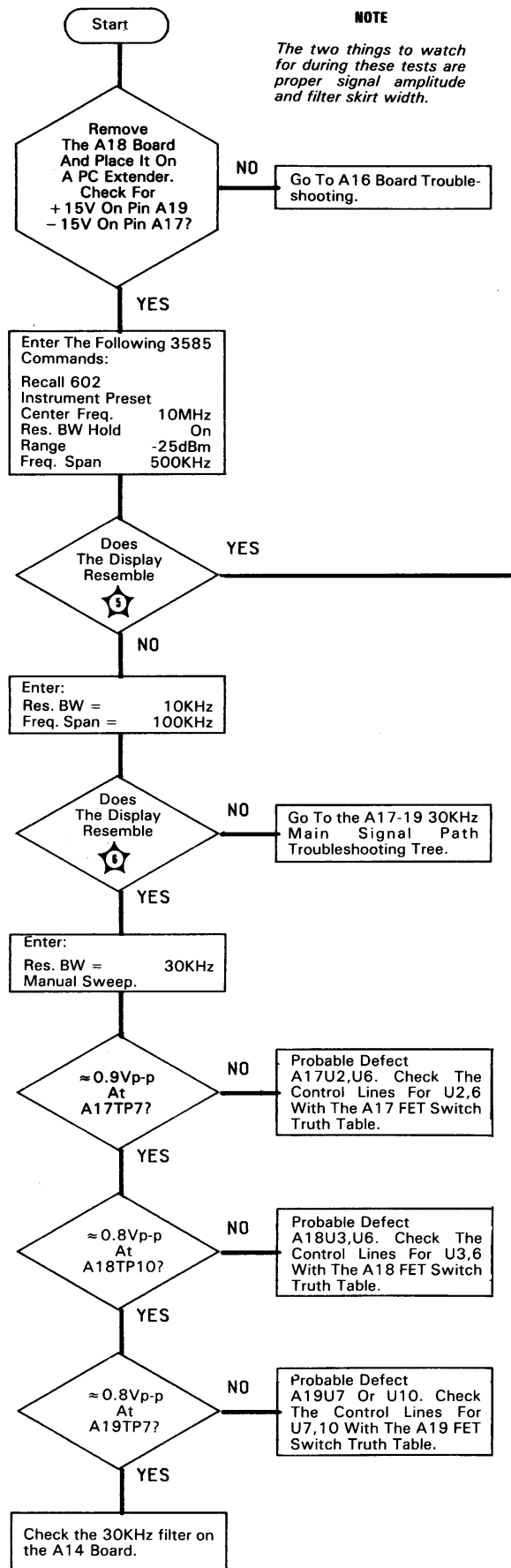
**A19**  
03585-66519



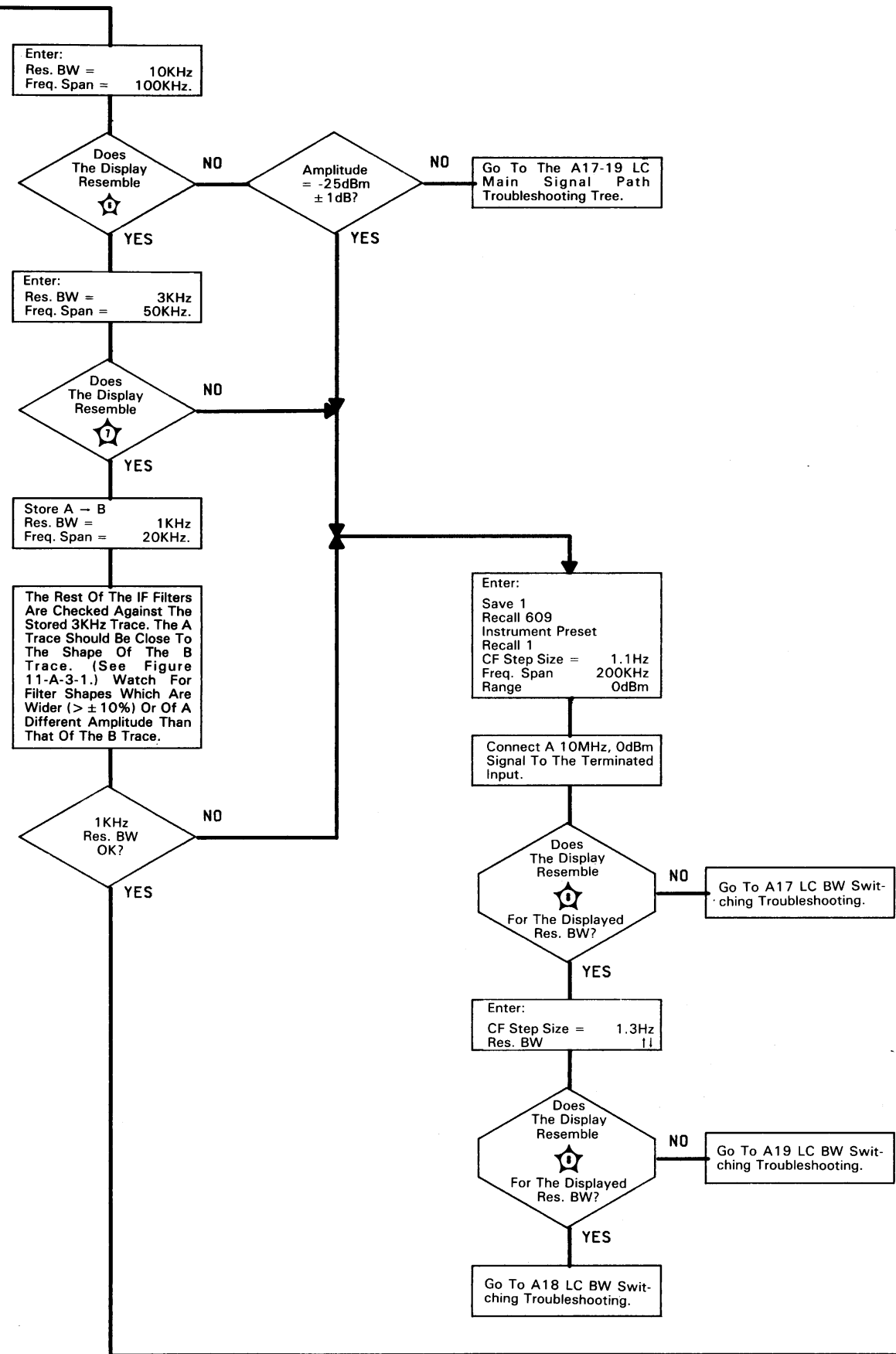
**NOTE**  
If the problem is not on the A17 board, A5T4,5 may be misadjusted.



A18  
03585-66518



**NOTE**  
If the problem is not on the A17 board, A5T4,5 may be misadjusted.



NO  
Go To The A17-19 LC Main Signal Path Troubleshooting Tree.

Enter:  
Save 1  
Recall 609  
Instrument Preset  
Recall 1  
CF Step Size = 1.1Hz  
Freq. Span 200KHz  
Range OdBm

Connect A 10MHz, OdBm Signal To The Terminated Input.

Does The Display Resemble  
For The Displayed Res. BW?  
0

NO  
Go To A17 LC BW Switching Troubleshooting.

Enter:  
CF Step Size = 1.3Hz  
Res. BW 11

Does The Display Resemble  
For The Displayed Res. BW?  
1

NO  
Go To A19 LC BW Switching Troubleshooting.

Go To A18 LC BW Switching Troubleshooting.

Enter:  
Res. BW = 300Hz  
Freq. Span = 5KHz  
Sweep Time = 0.8sec.

300Hz Res. BW OK?  
14

NO

YES

Enter:  
Res. BW = 100Hz  
Freq. Span = 2KHz.

100Hz Res. BW OK?  
15

NO

YES

Enter:  
Res. BW = 30Hz  
Freq. Span = 500Hz.

30Hz Res. BW OK?  
16

NO

YES

Enter:  
Res. BW = 10Hz  
Freq. Span = 200Hz

10Hz Res. BW OK?  
17

NO

YES

Enter:  
Res. BW = 3Hz  
Freq. Span = 50Hz.

3Hz Res. BW OK?  
18

NO

YES

Amplitude -25dBm ± 0.6dB?

NO

YES

Go To The A17-19 Crystal BW Main Signal Path Troubleshooting.

Set The 3585 For:  
Save 1  
Recall 609  
Instrument Preset  
Recall 1  
View B Off  
CF Step Size = 1.1Hz  
Range OdBm  
Frequency Span =  
20KHz For 300Hz RBW  
10KHz For 100Hz RBW  
5KHz For 30Hz RBW  
1KHz For 10Hz RBW  
200Hz For 3Hz RBW

NOTE  
To set the proper Frequency span, check the Res. BW value displayed on the CRT and enter the corresponding Frequency span.

Connect a 10MHz, OdBm Signal To The 3585's Terminated Input.

Find The Figure Which Corresponds To The Displayed Res. BW. Does The CRT Display Closely Resemble That Figure?  
14 15 16 17 18

NO

YES

Enter:  
CF Step Size 1.3Hz  
Res BW 11

Does The CRT Display Closely Resemble The Previously Selected Figure?

NO

YES

Go To A18 Crystal BW Switching Troubleshooting.

IF Attenuator Test.

1. Turn The 3585 Off.
2. Place The A15 Board On An Extender.
3. Ground The Top Of A15R12.

Enter:  
Recall 603  
Instrument Preset  
Range -25dBm  
Ref. Level -15dBm  
Center Freq. 20MHz  
Freq. Span 0Hz  
Res. BW 100Hz  
Video BW 10Hz  
Sweep Time 35sec

Press The Manual Sweep And Clear A Keys. The Marker Amplitude Should Now Read -75dBm ± 5dB.

Press The "CF" Key (In The Marker/Continuous Entry Block) And Adjust The Center Frequency To Obtain A Marker Reading Of -95dBm.  
19

Activate:  
Ref Lvl (Marker/Continuous Entry Block)  
Single Sweep  
Clear A  
The Sweep Is Now Armed. When You Start The Sweep Rotate The Continuous Entry Knob Slowly And Smoothly Counter-Clockwise. This Will Produce A Stair Step Display Similar To The One Shown In  
20

Start The Sweep By Pressing Single Sweep.

Activate The Marker Key (Marker/Continuous Entry Block) And Move The Marker To The Bottom Of The Stairstep Response.

Press:  
Offset On  
Enter Offset.

Move The Marker To A Flat Portion Of Each Step And Observe The Offset Marker Amplitude Reading. The Readings Should Correspond To Those In Table 11-A-3-1 ± 0.5dB.

Do Your Readings Agree With The Marker Readings Shown In Table 11-A-3-1 ± 0.5dB?

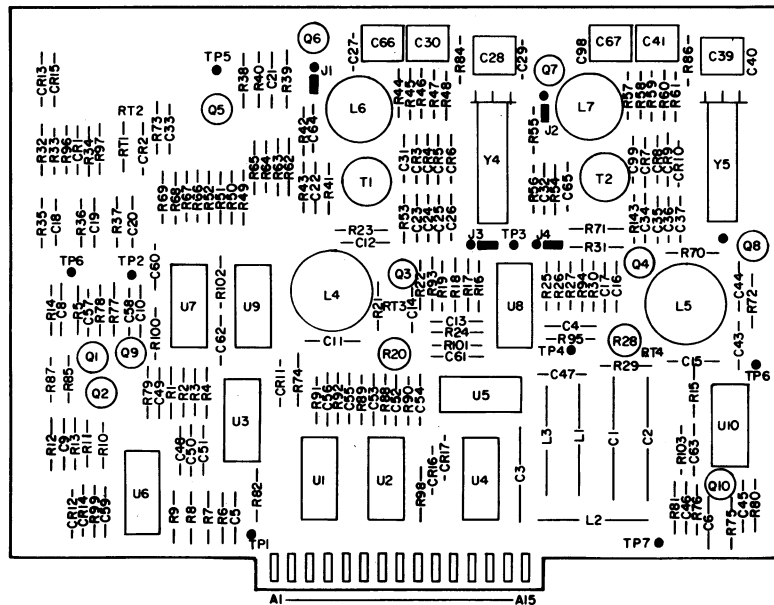
NO

YES

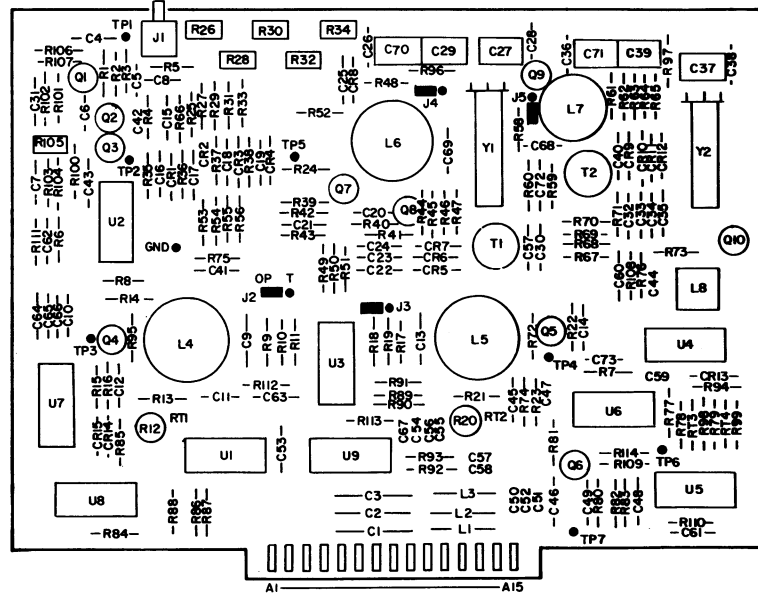
Return To The Main Troubleshooting Tree.

Table 11-A-3-1. Stairstep Offset Amplitude Readings

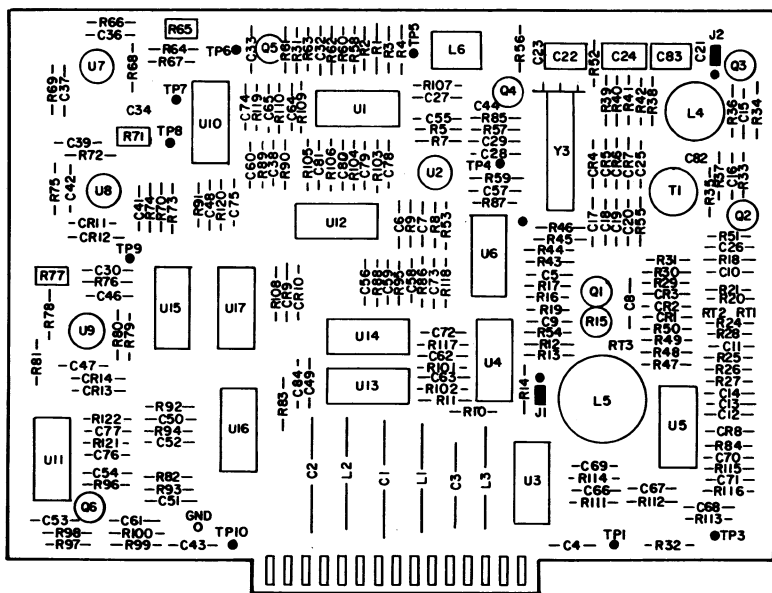
Step#	Marker Reading	Step#	Marker Reading
1	4	20	40
2	8	11	44
3	12	12	48
4	16	13	52
5	20	14	56
6	24	15	60
7	28	16	64
8	32	17	68
9	36		



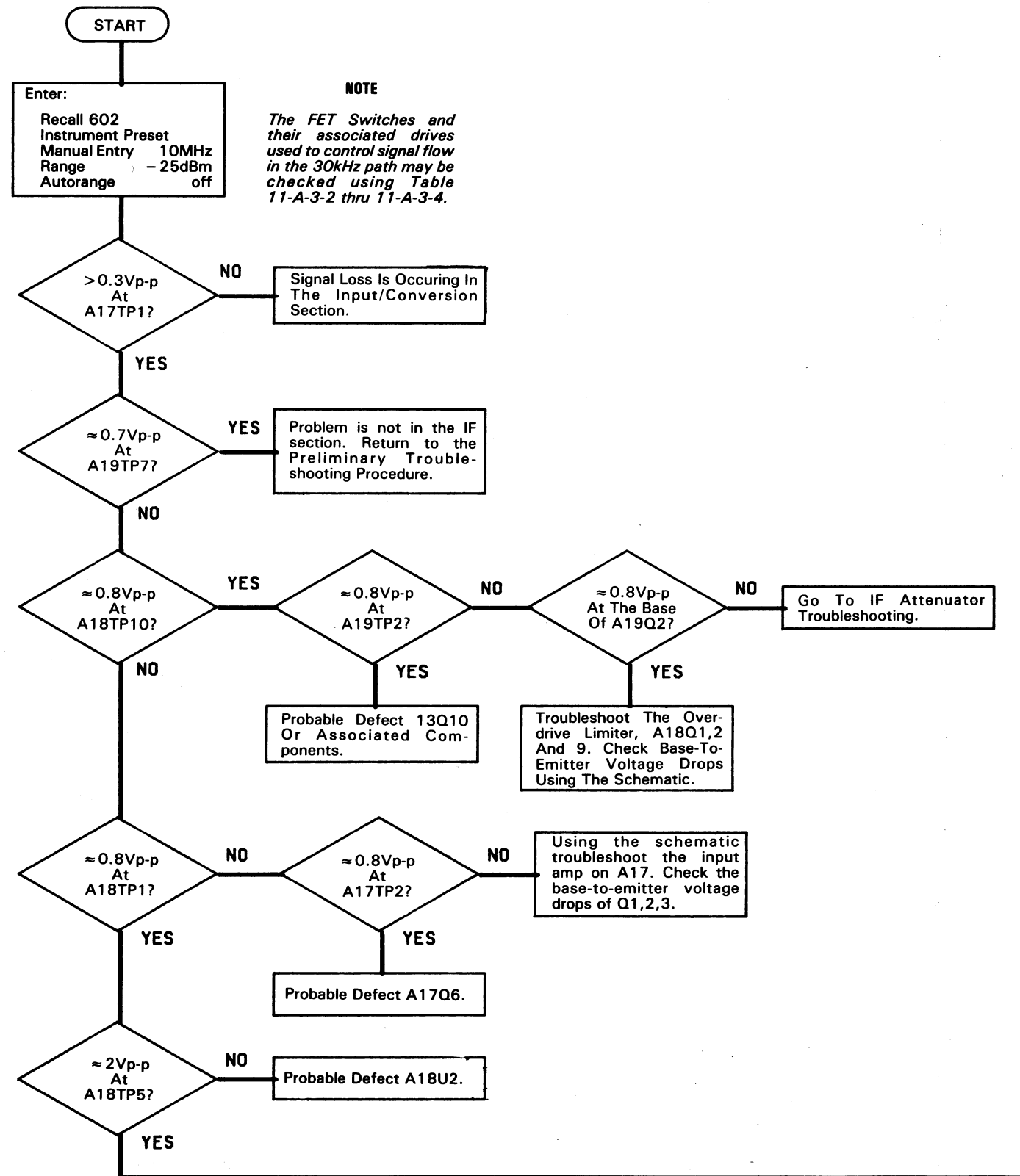
A17  
03585-86517

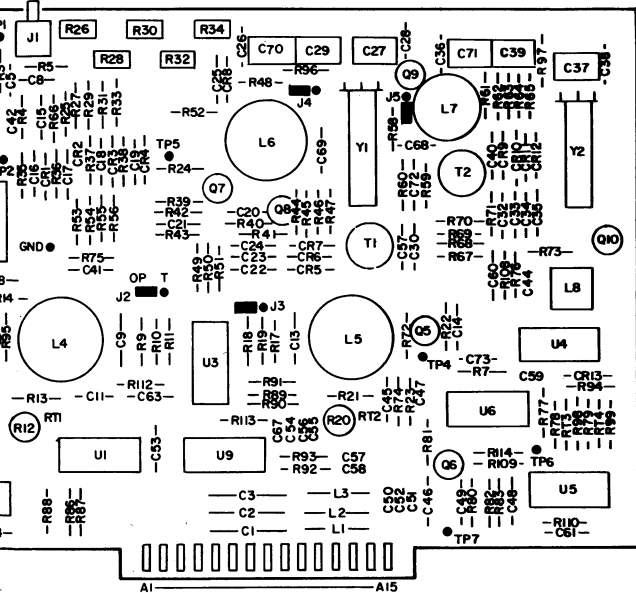


A18  
03585-86518

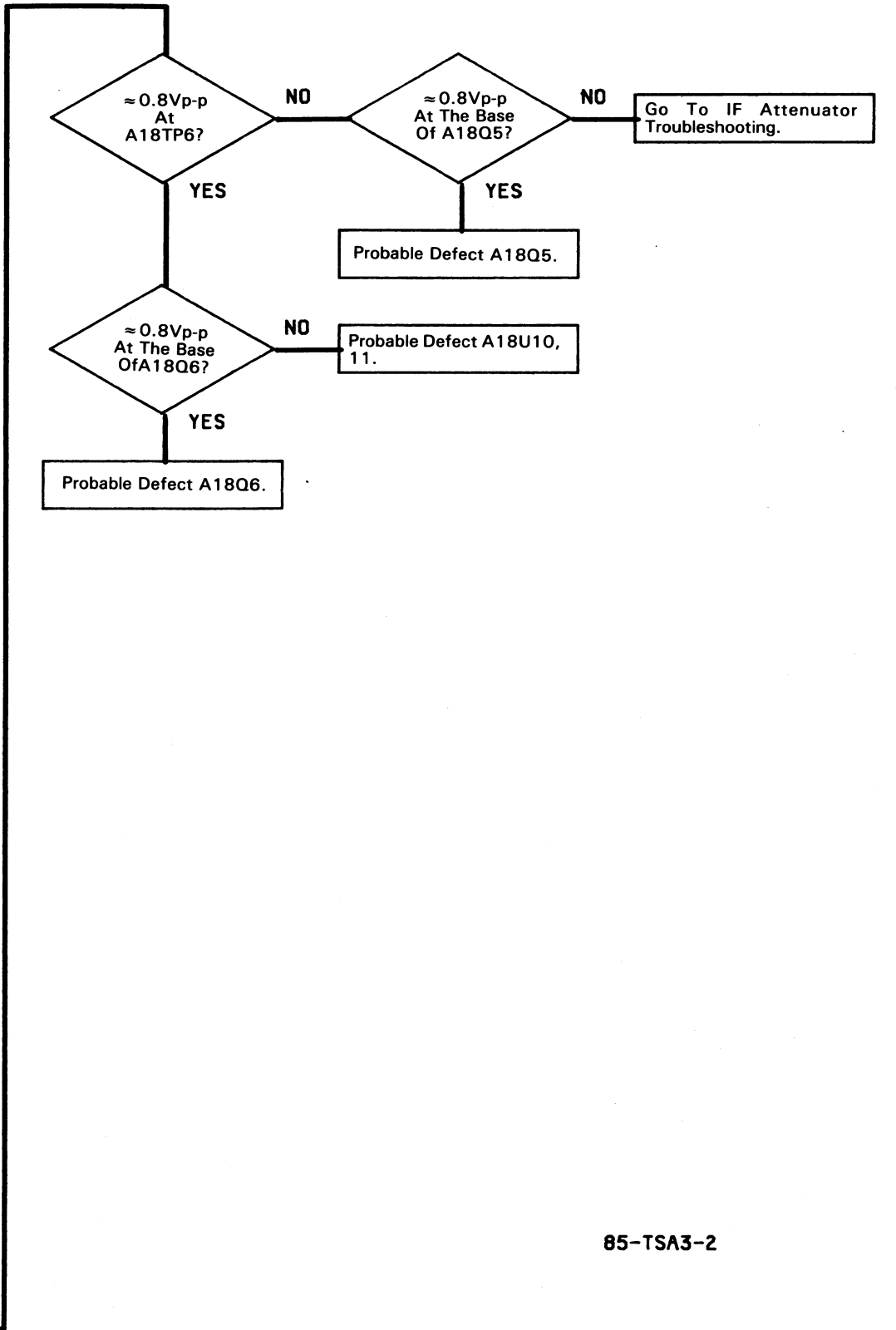
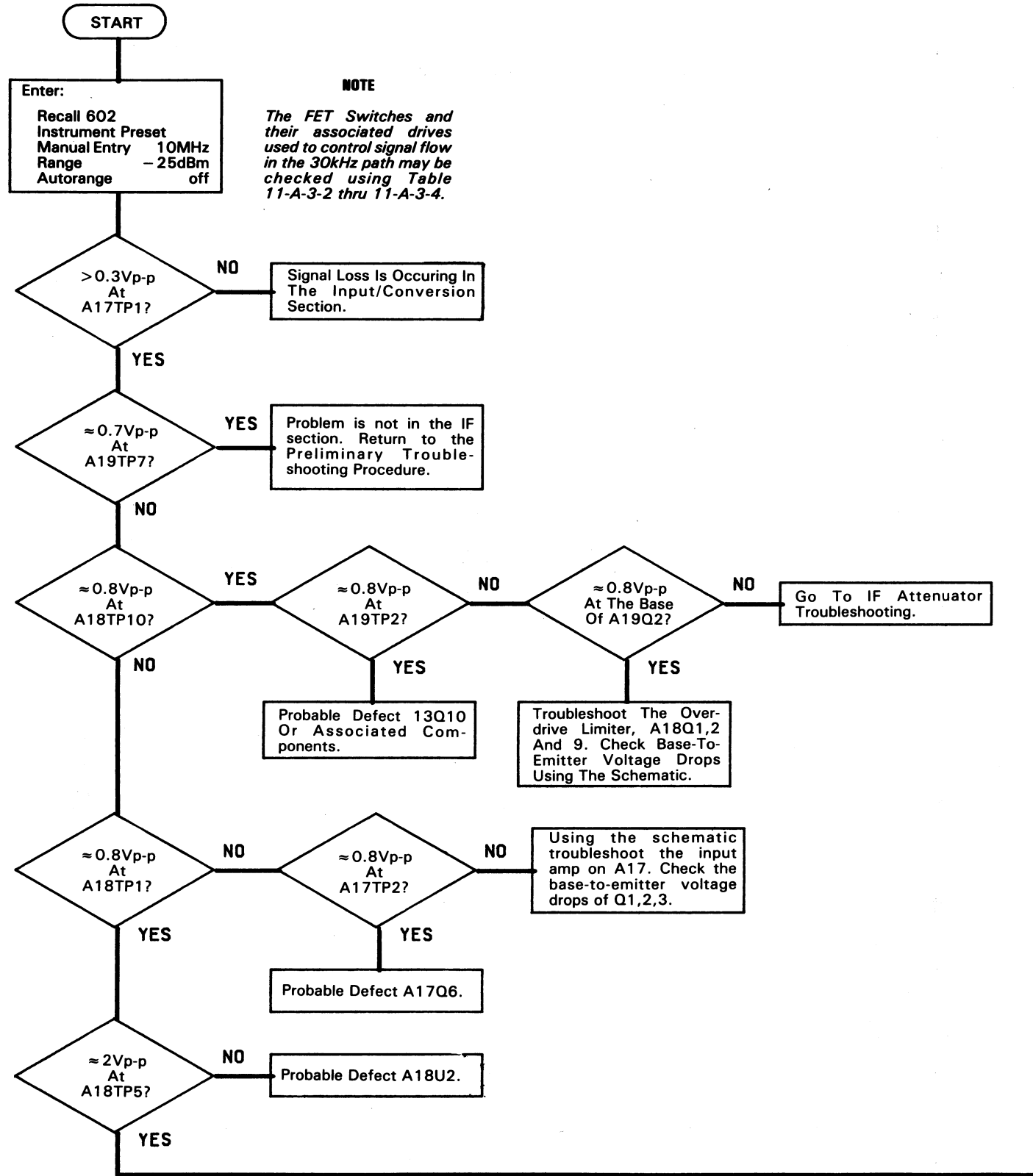


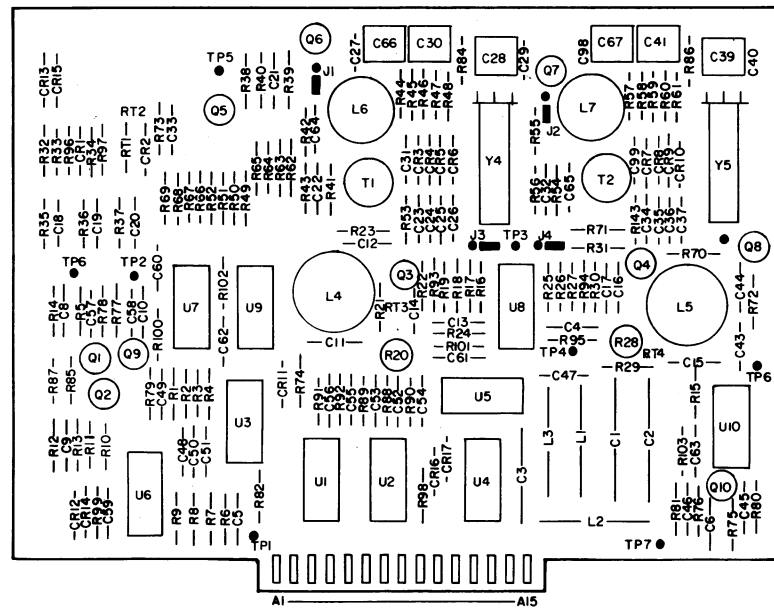
A19  
03585-86519



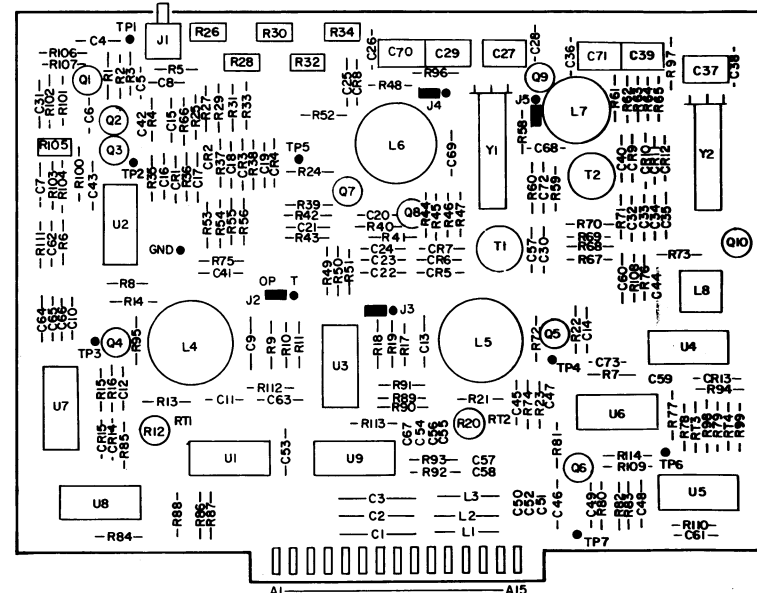


A18  
03585-86518

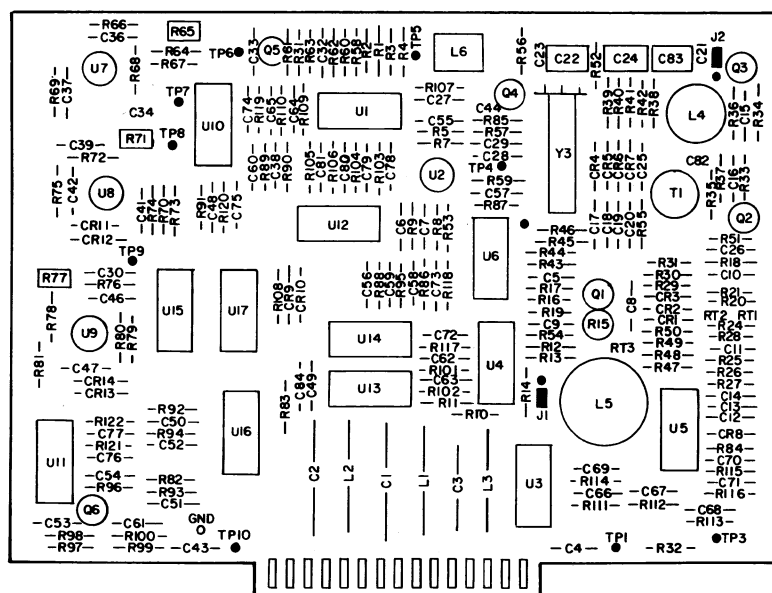




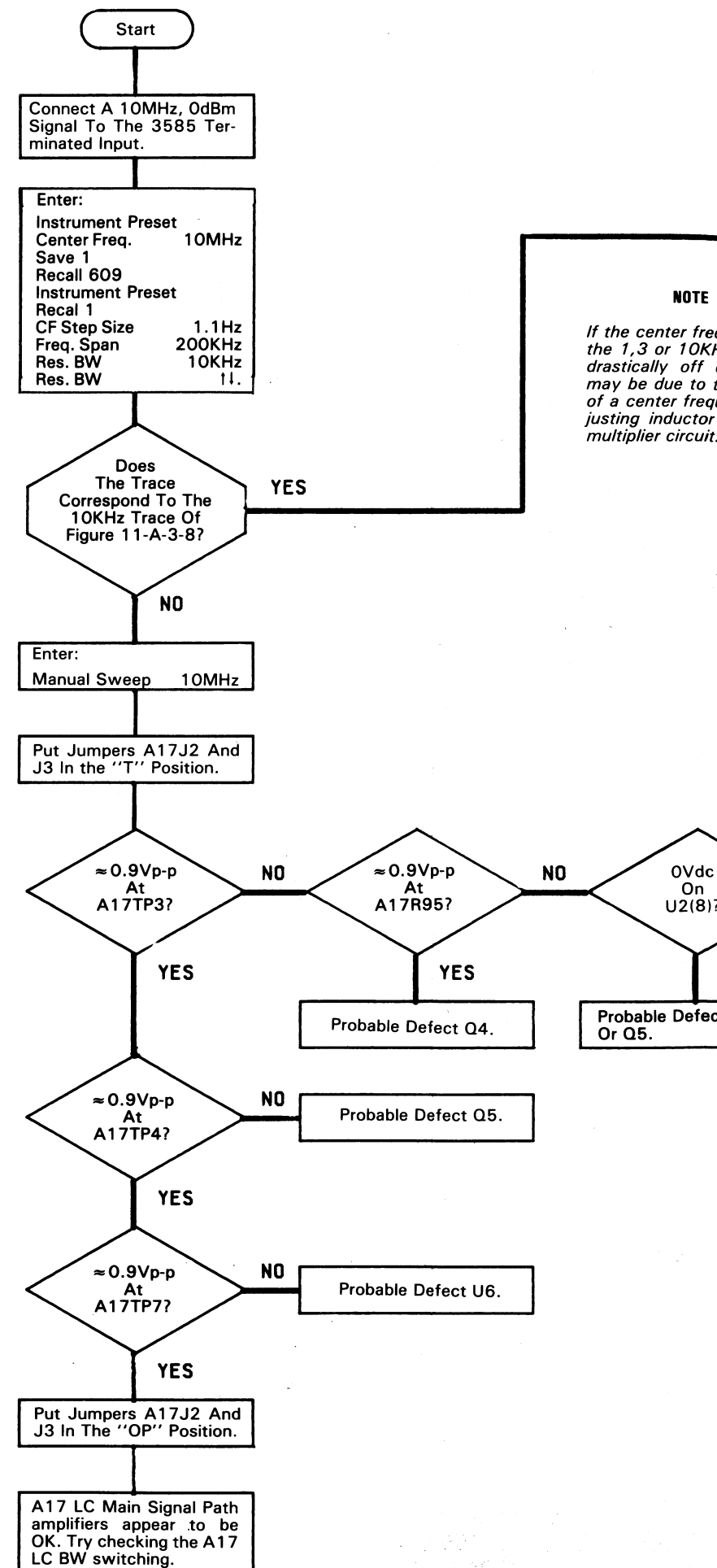
A17  
03585-86517



A18  
03585-86518



A19  
03585-86519



**NOTE**  
If the center frequency is drastically off the 10KHz trace, it may be due to a misadjusted center frequency multiplier circuit.

Start

Connect A 10MHz, 0dBm Signal To The 3585 Terminated Input.

Enter:  
Instrument Preset  
Center Freq. 10MHz  
Save 1  
Recall 609  
Instrument Preset  
Recal 1  
CF Step Size 1.1Hz  
Freq. Span 200KHz  
Res. BW 10KHz  
Res. BW 11.

Does The Trace Correspond To The 10KHz Trace Of Figure 11-A-3-8?

YES

NO

Enter:  
Manual Sweep 10MHz

Put Jumpers A17J2 And J3 In The "T" Position.

≈ 0.9Vp-p At A17TP3?

NO

YES

≈ 0.9Vp-p At A17TP4?

NO

YES

≈ 0.9Vp-p At A17TP7?

NO

YES

Put Jumpers A17J2 And J3 In The "OP" Position.

A17 LC Main Signal Path amplifiers appear to be OK. Try checking the A17 LC BW switching.

**NOTE**  
If the center frequency of the 1,3 or 10KHz filter is drastically off center, it may be due to the failure of a center frequency adjusting inductor in the Q multiplier circuit.

Enter The Following Commands:  
CF Step Size 1.3Hz  
Res. BW 11.

Does The Trace Correspond To The 10KHz Trace Of Figure 11-A-3-8?

NO

YES

Enter:  
Manual Sweep 10MHz  
CF Step Size 1.2Hz  
RES BW 11

Put Jumper A18J1 In The "T" Position.

≈ 0.9Vp-p At A18TP2?

NO

YES

2.25Vp-p At A18TP5?

NO

YES

Put Jumper A18J1 In The "OP" Position.

A18 LC Main Signal Path amplifiers appear to be OK. Try checking the A18 LC BW switching Troubleshooting.

Enter:  
Manual Sweep 10MHz

Put jumpers A19J3 J4 In The "T" Position.

≈ 0.9Vp-p At A19TP3?

YES

≈ 0.9Vp-p At A19TP4?

YES

≈ 0.9Vp-p At A19TP7?

YES

Put Jumpers A19J3 J4 In The "OP" Position.

A19 LC Main signal amplifiers appear to be OK. Try checking the LC BW switching.

Go To IF DSA Troubleshooting. If The Signatures Are Correct, Probable Defect Is U1.

Go To IF DSA Troubleshooting If The Signatures Are Correct, The Probable Defect Is U14.

Probable Defect Q4.

Probable Defect U2, Q4 Or Q5.

Probable Defect Q1.

Probable Defect U3 Or Q1.

Probable Defect Q5.

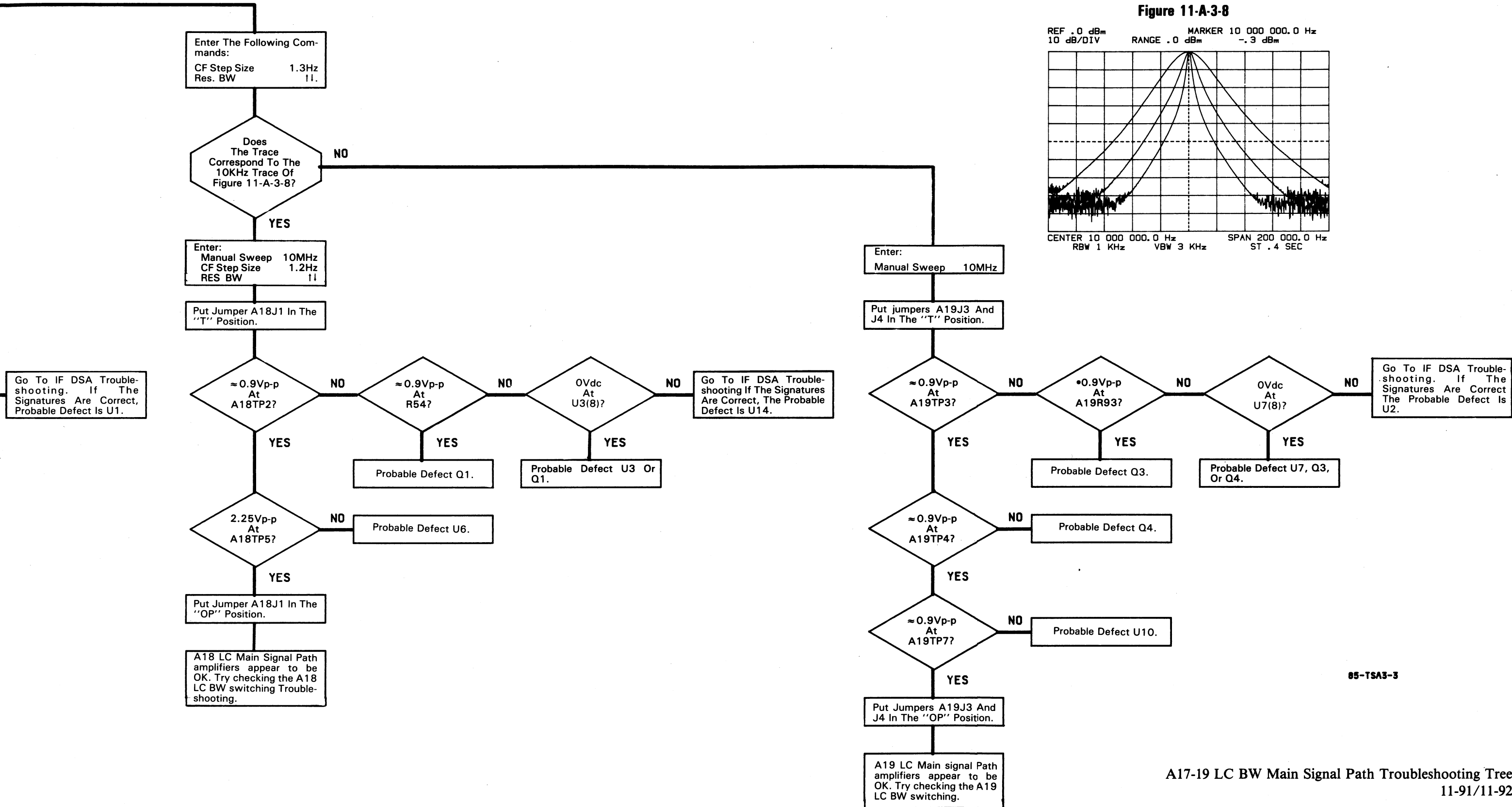
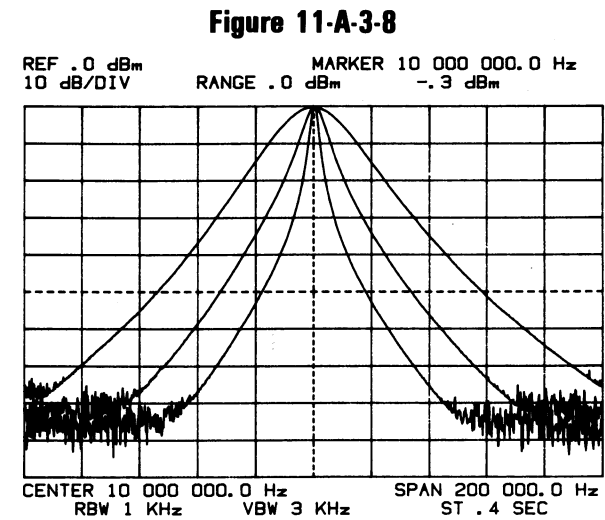
Probable Defect U6.

Probable Defect U6.

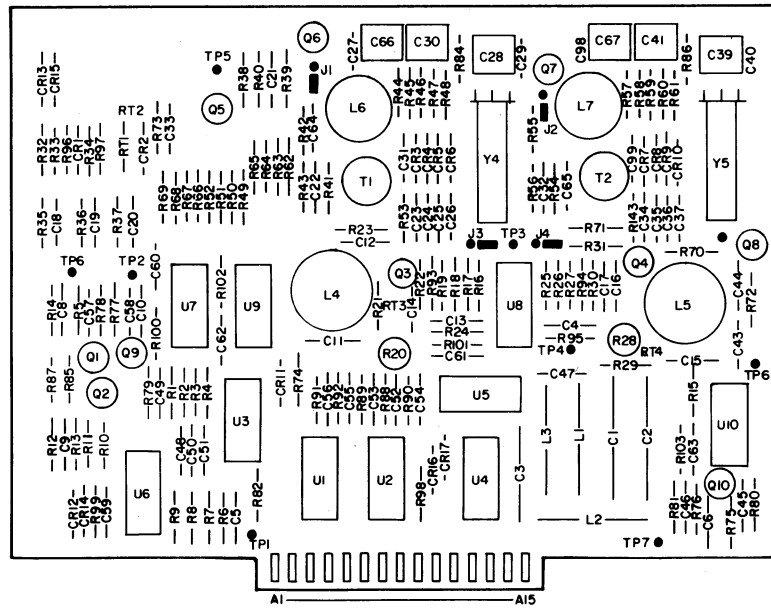
Probable Defect Q1.

Probable Defect U6.

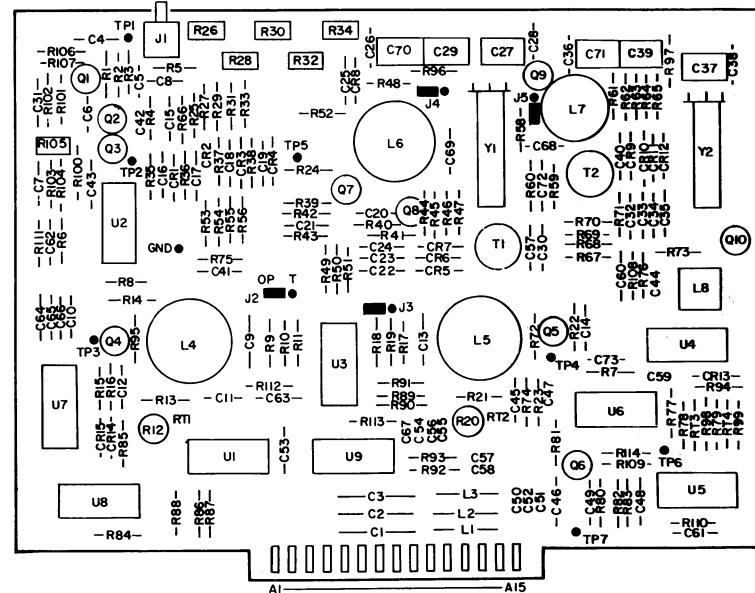




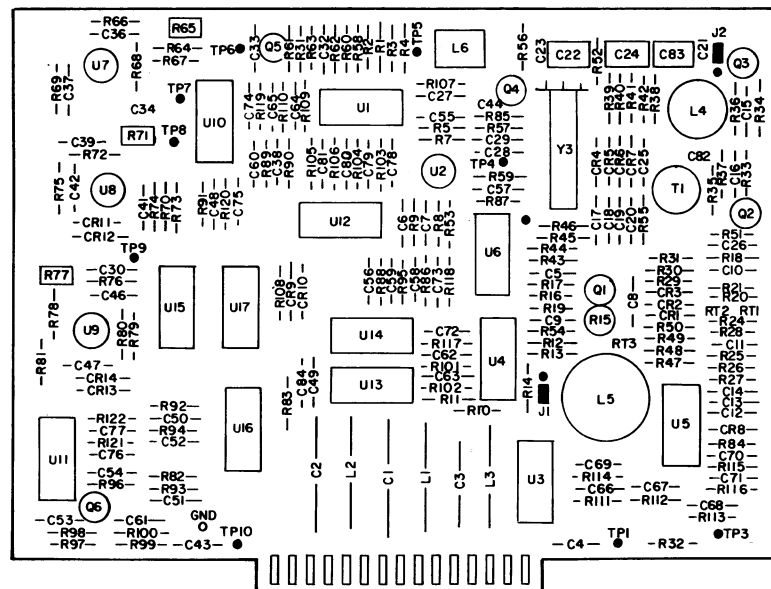
85-TSA3-3



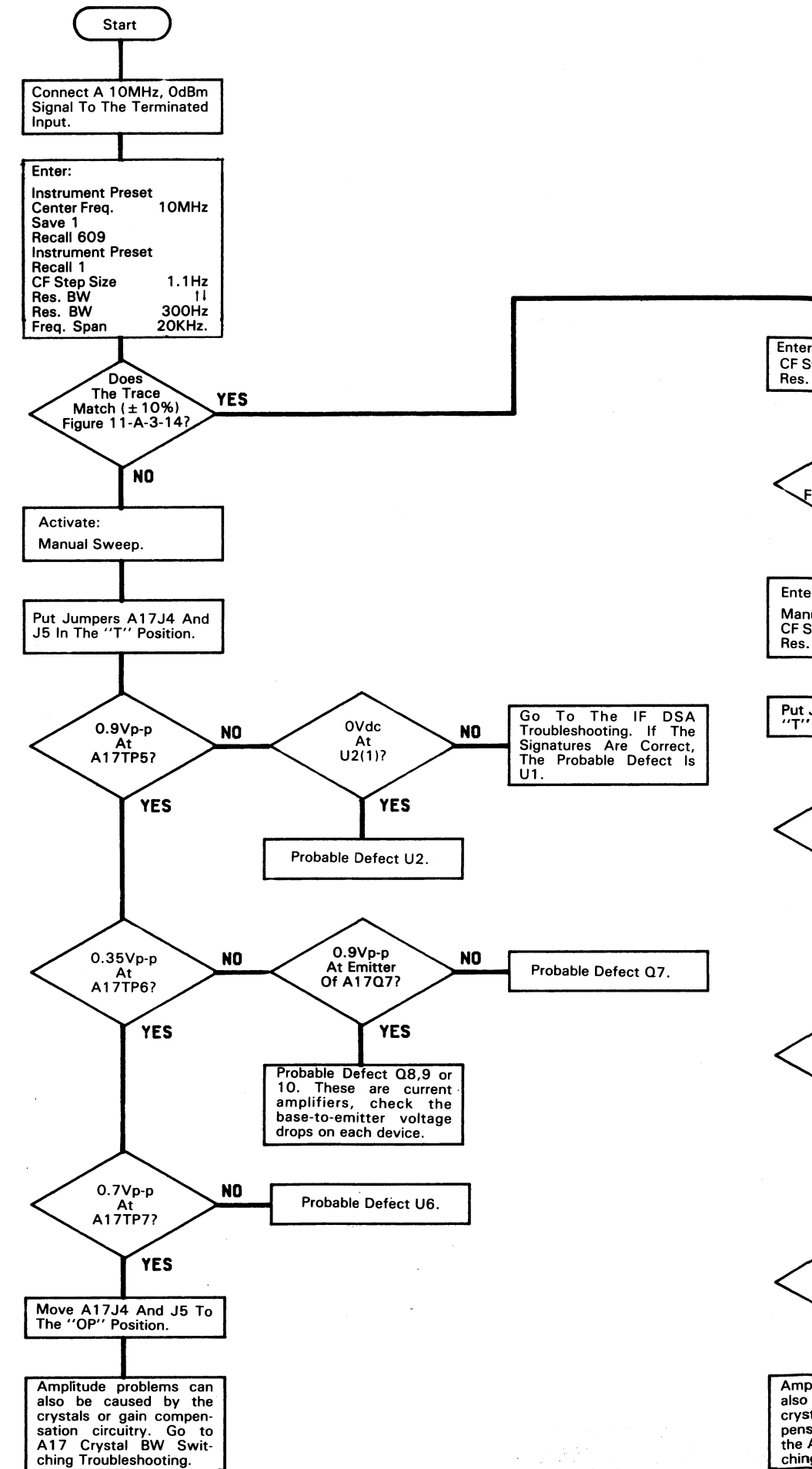
**A17**  
03585-66517



**A18**  
03585-66518



**A19**  
03585-66519



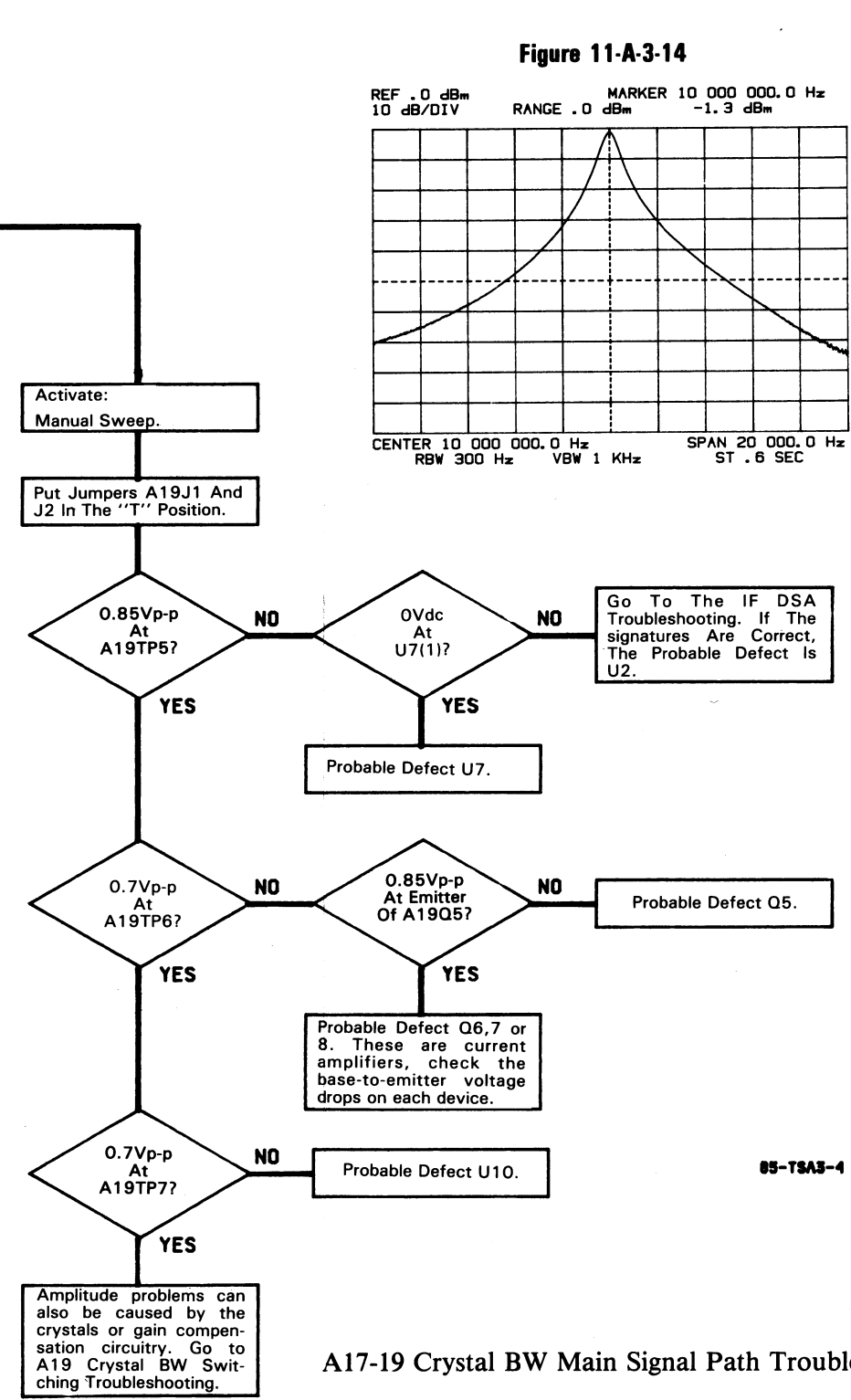
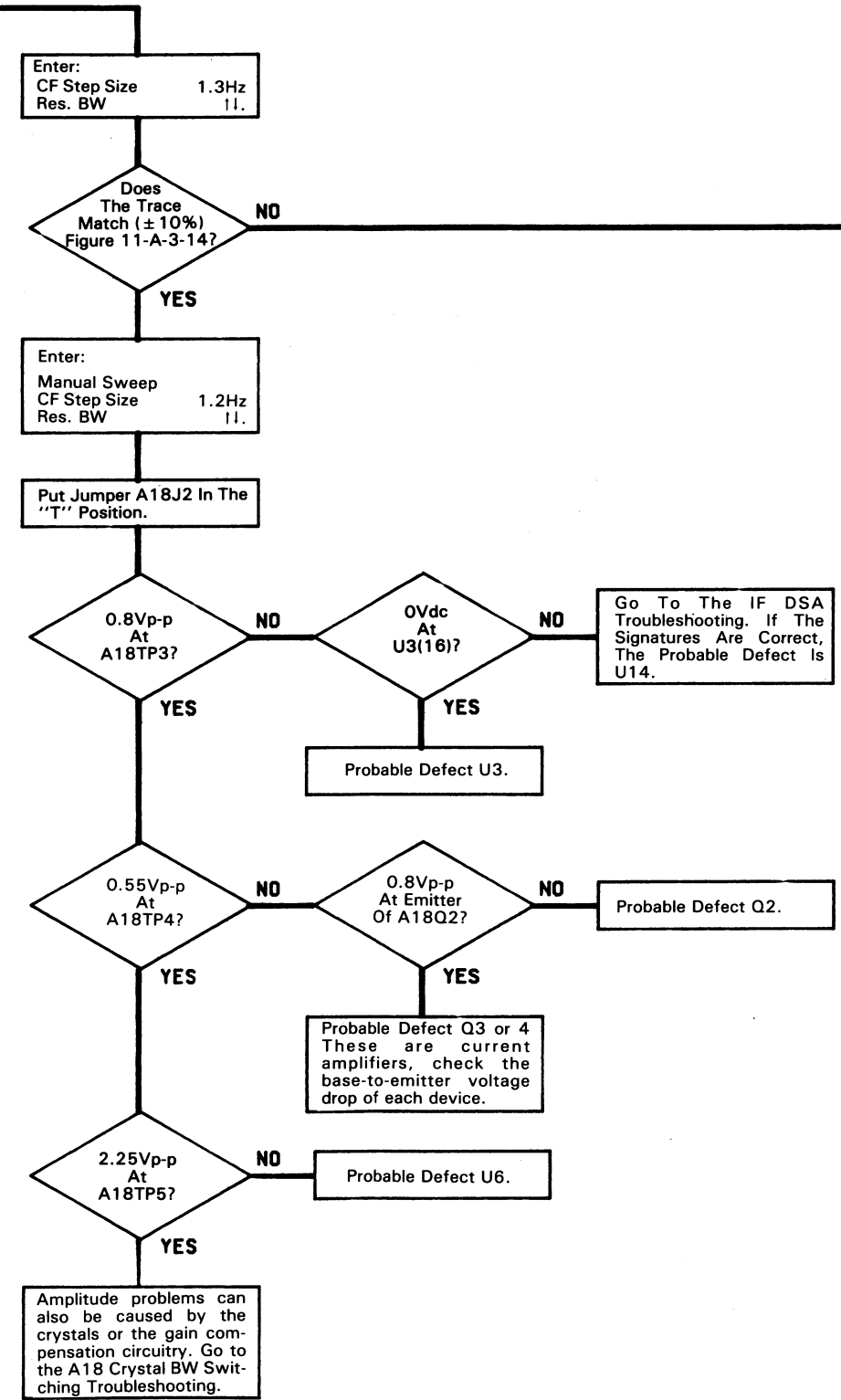
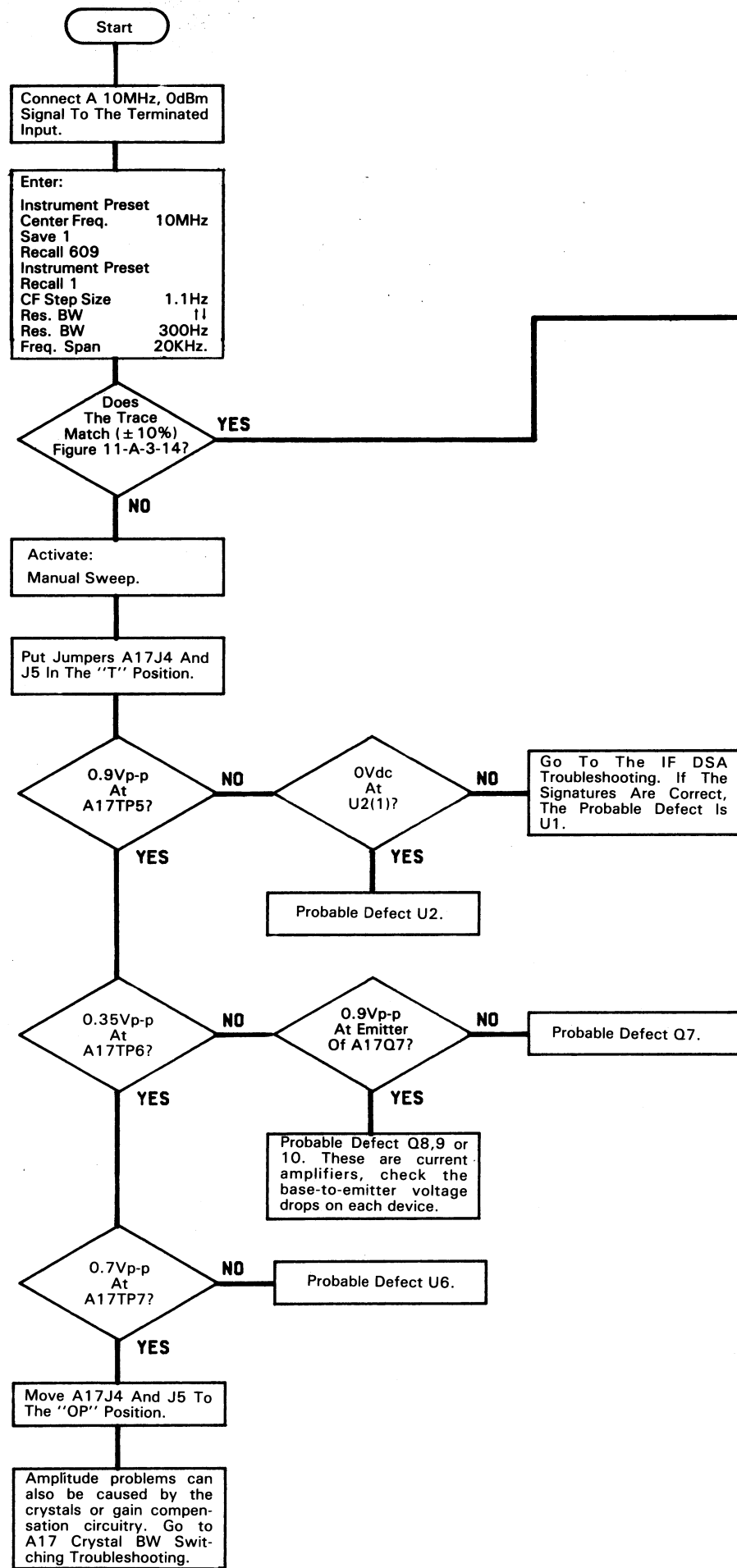
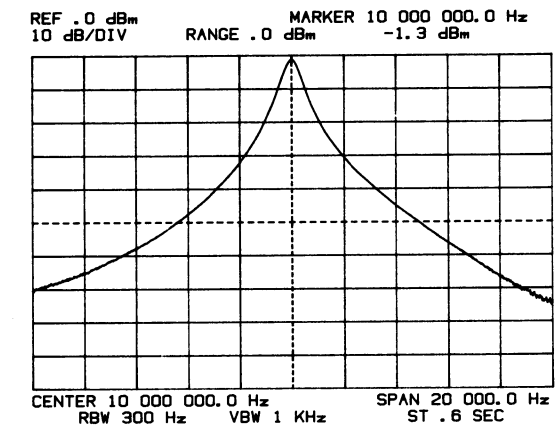
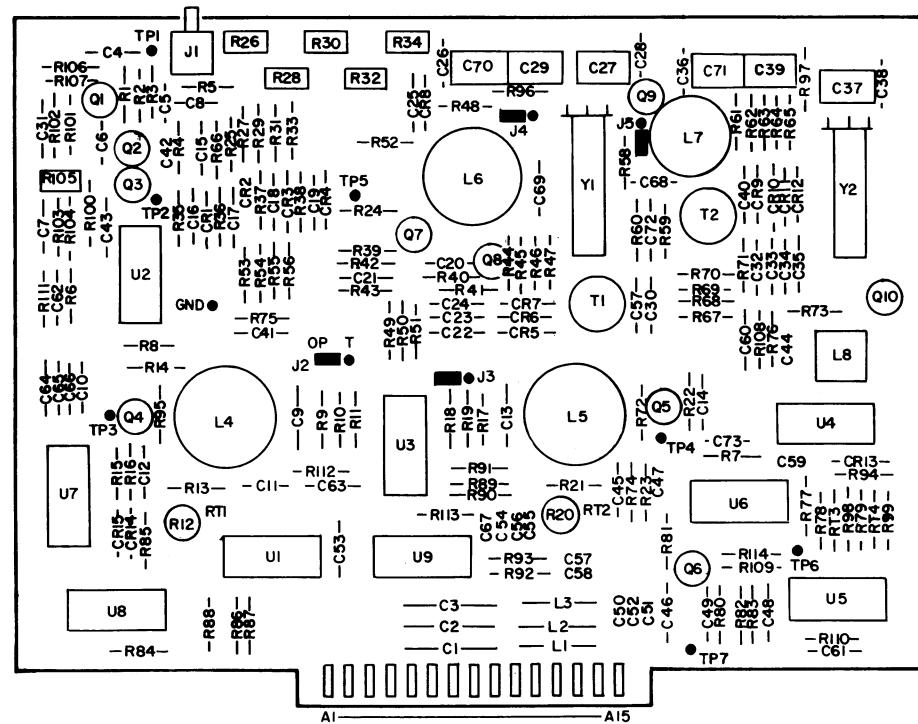


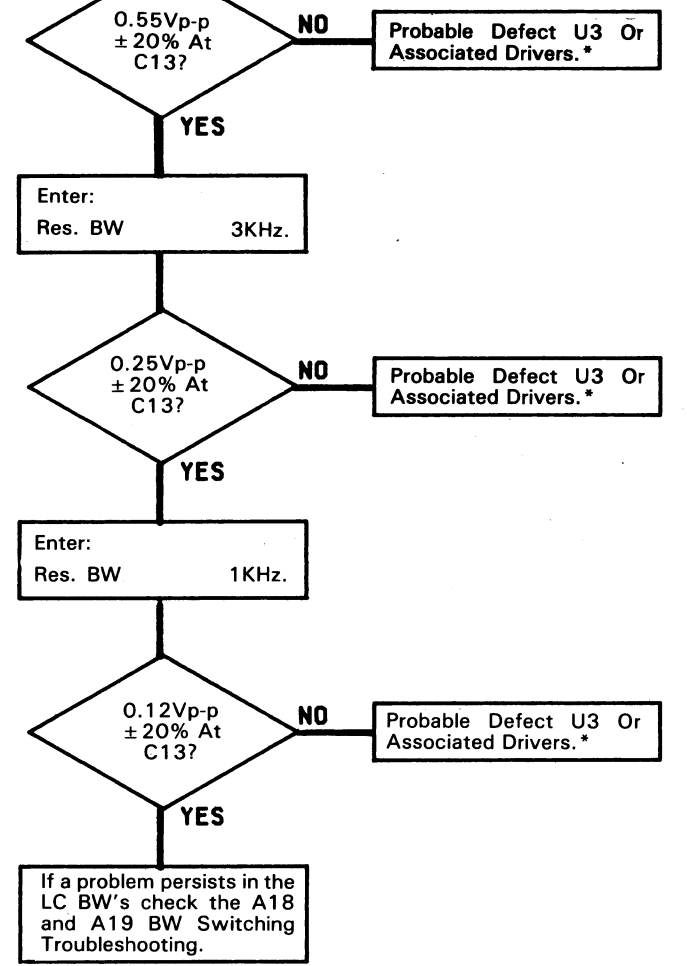
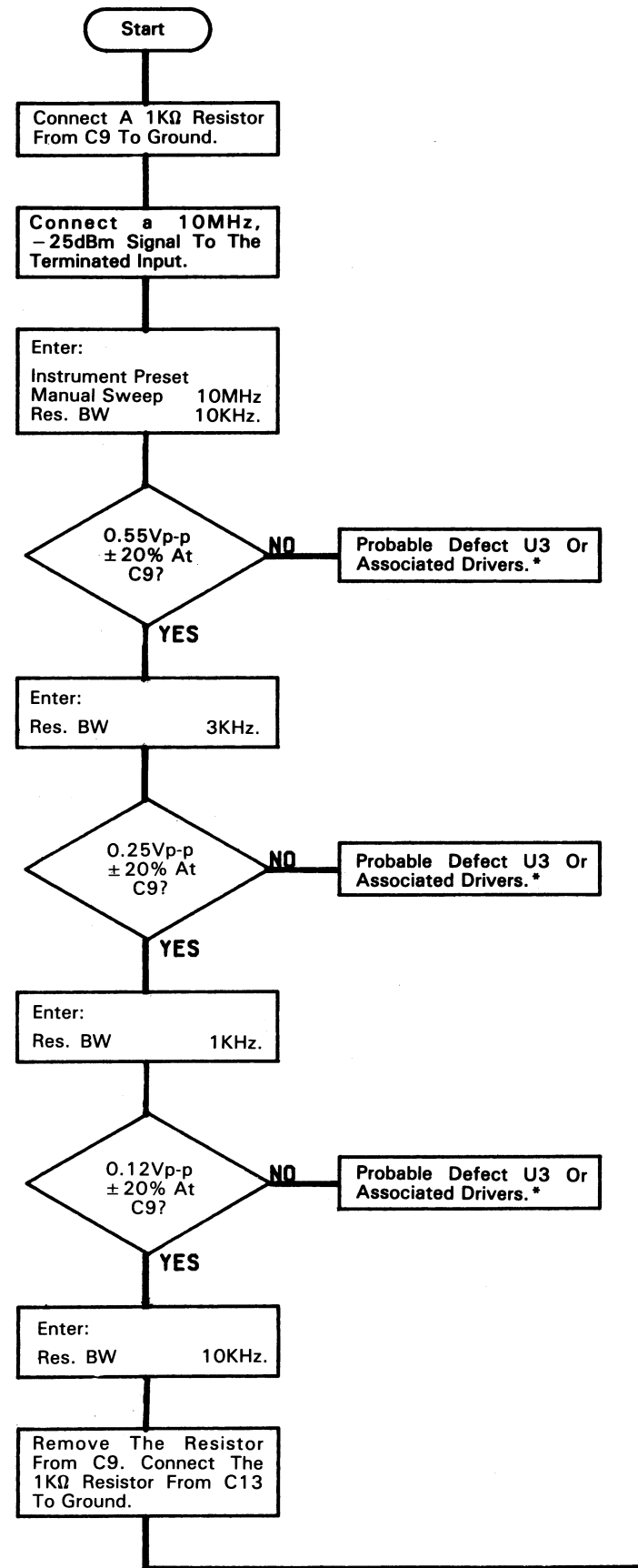
Figure 11-A-3-14



85-TSAS-4

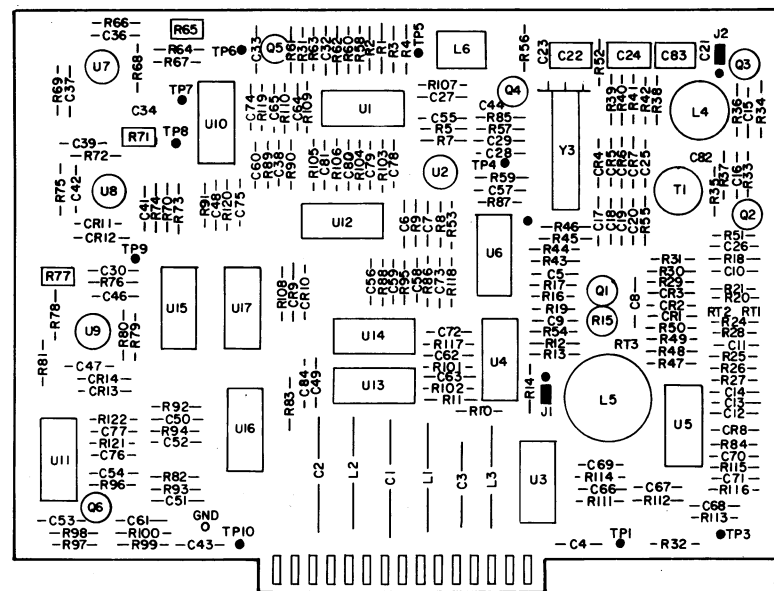


A17  
03585-66517

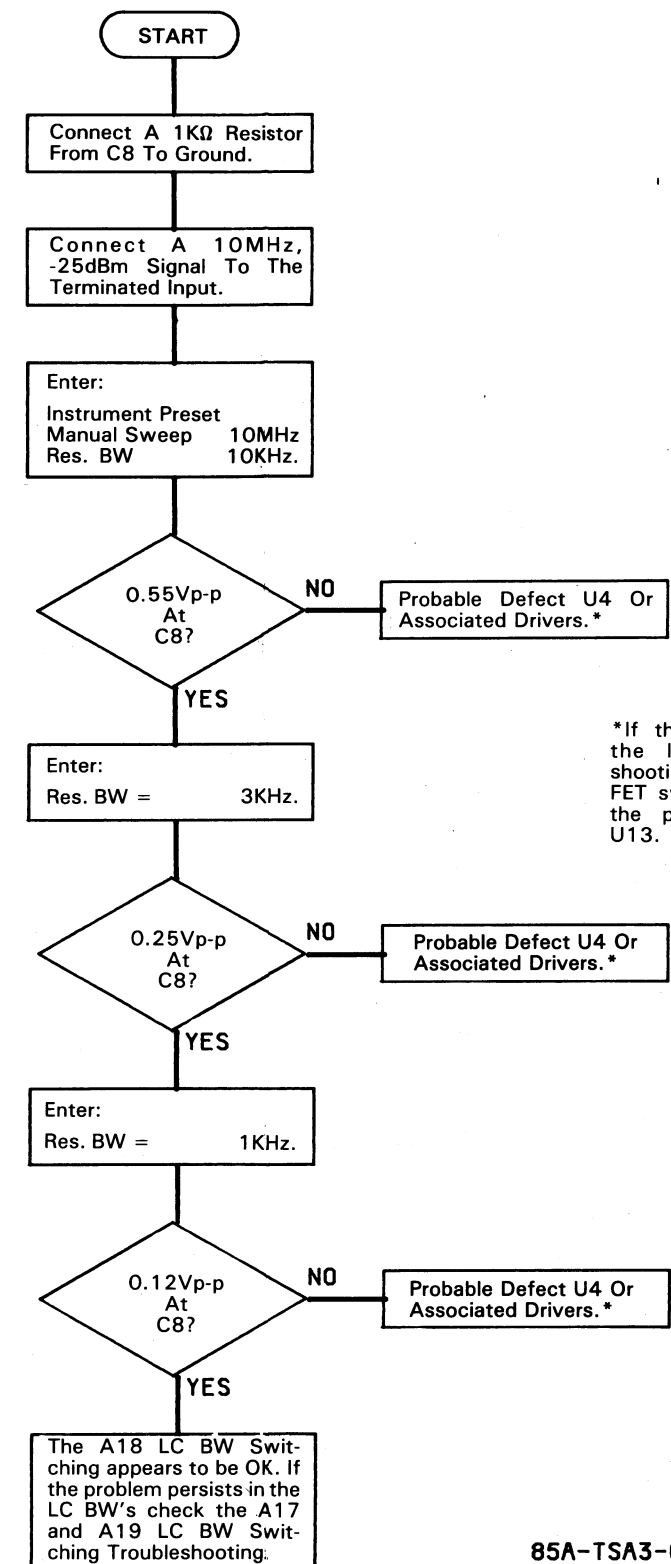


\*If the signatures from the IF DSA troubleshooting are correct to the FET Switch control lines, the probable defect is U9.

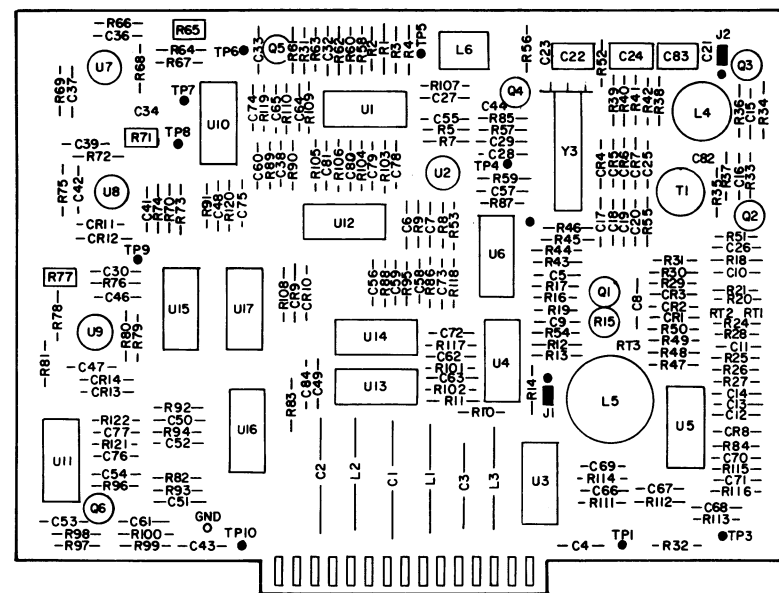
95-TSA3-6



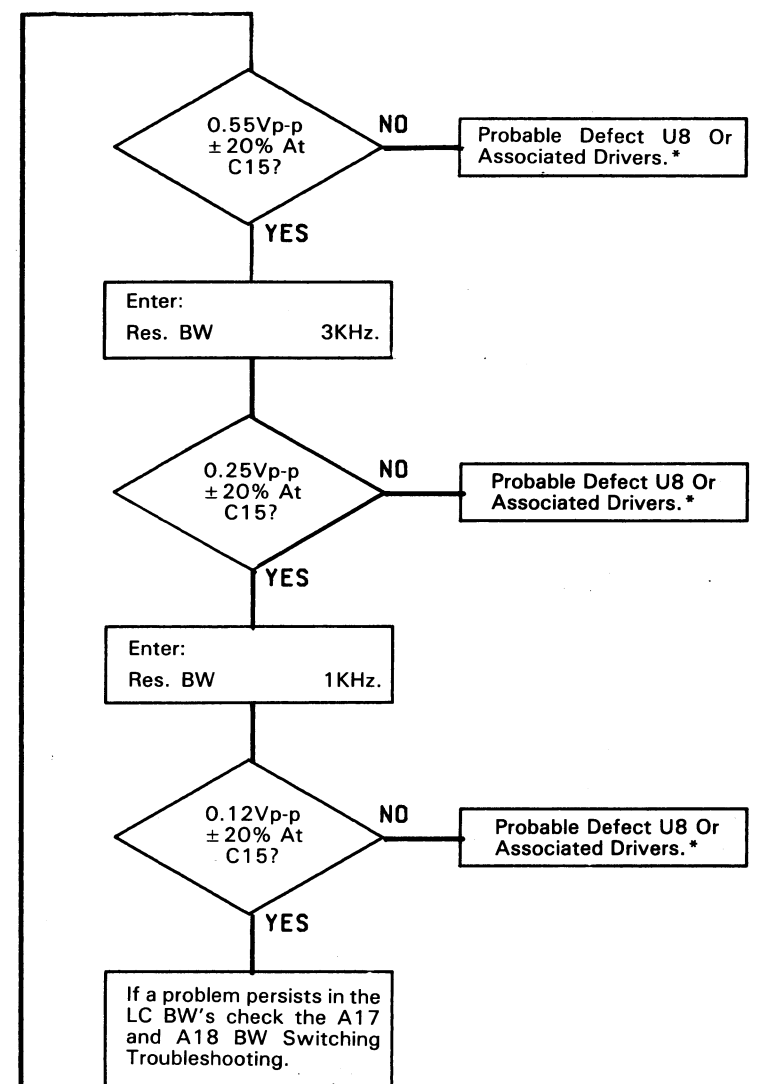
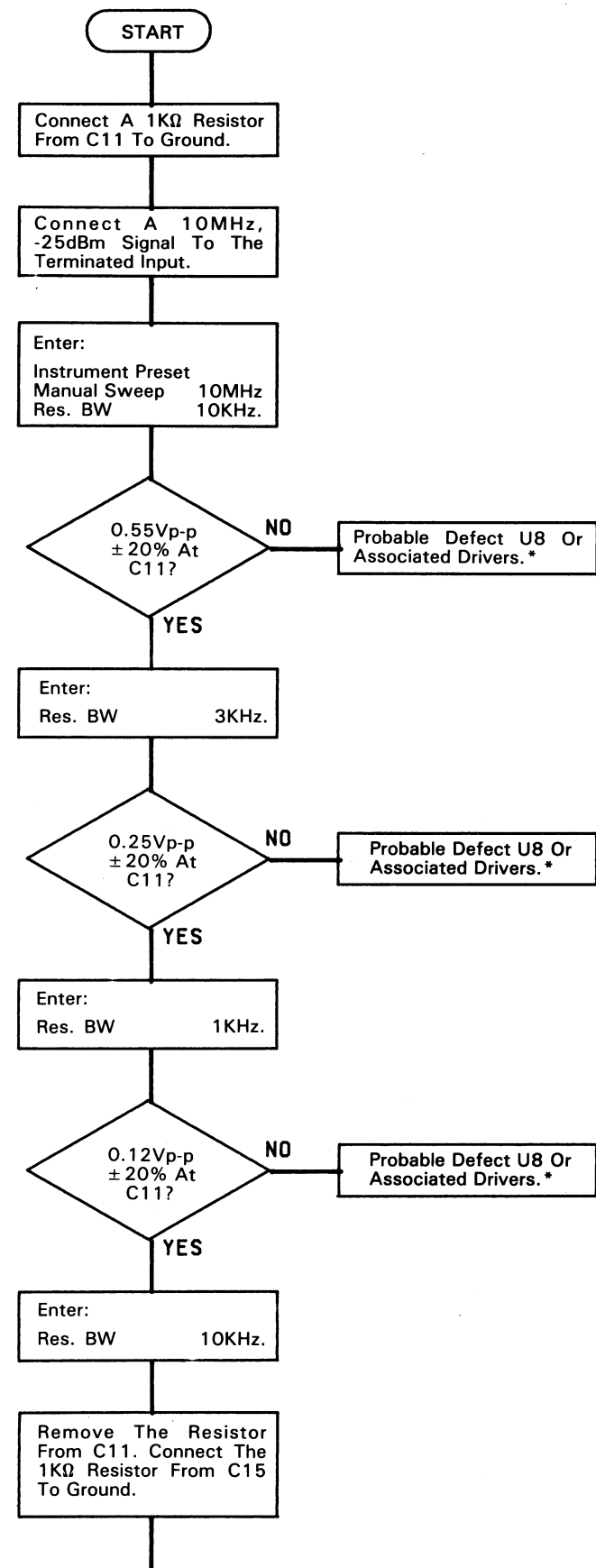
A18  
03585-88518



\*If the signatures from the IF DSA Troubleshooting are correct to the FET switch control lines, the probable defect is U13.

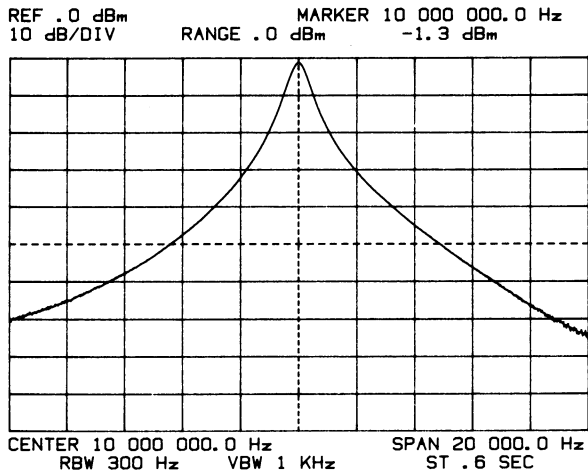


A18  
03585-66518

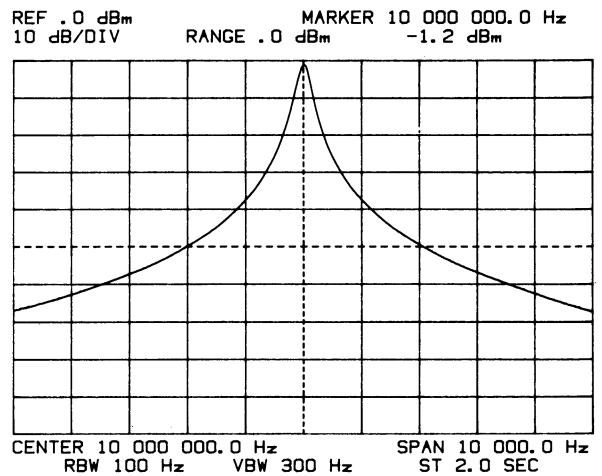


\*If the signatures from the IF DSA Troubleshooting are correct to the FET Switch control lines, the probable defect is U1.

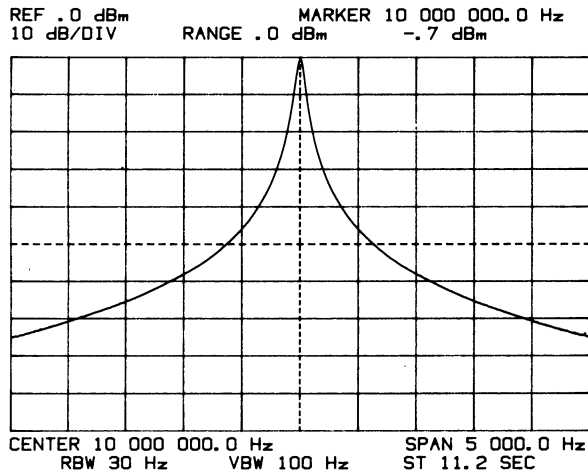
**Figure 11-A-3-14**



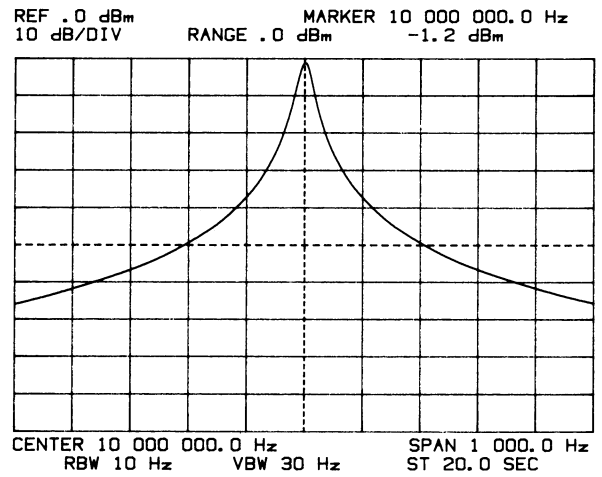
**Figure 11-A-3-15**



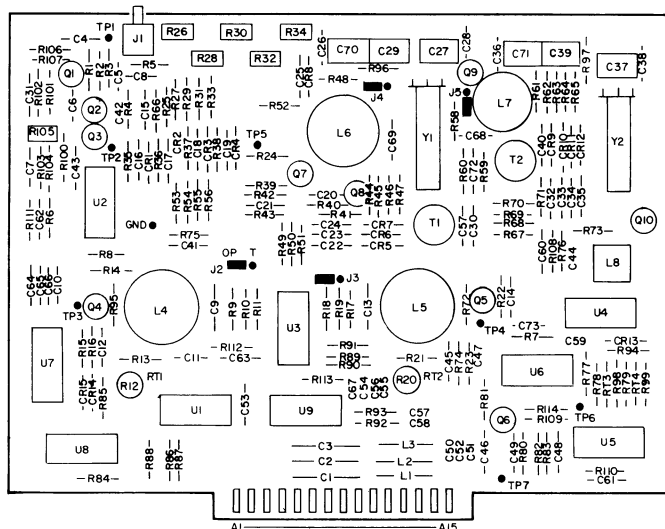
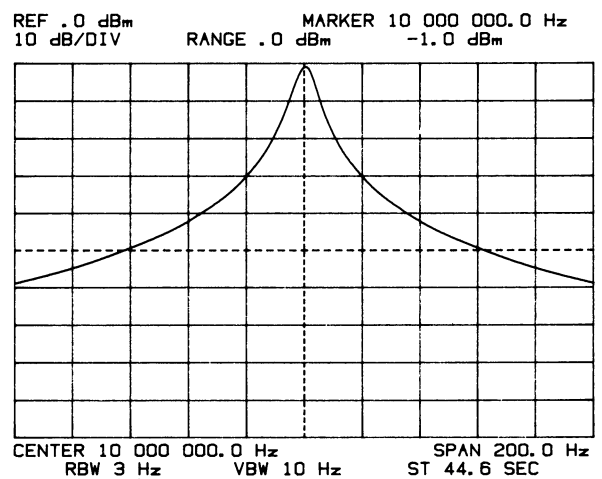
**Figure 11-A-3-16**

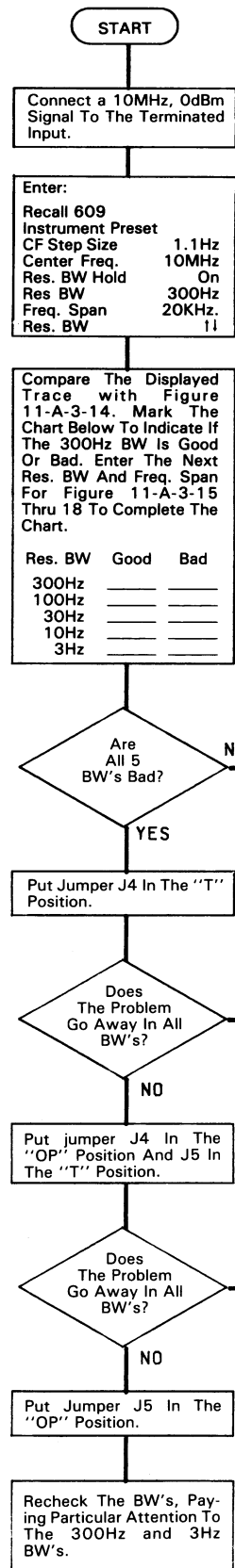


**Figure 11-A-3-17**

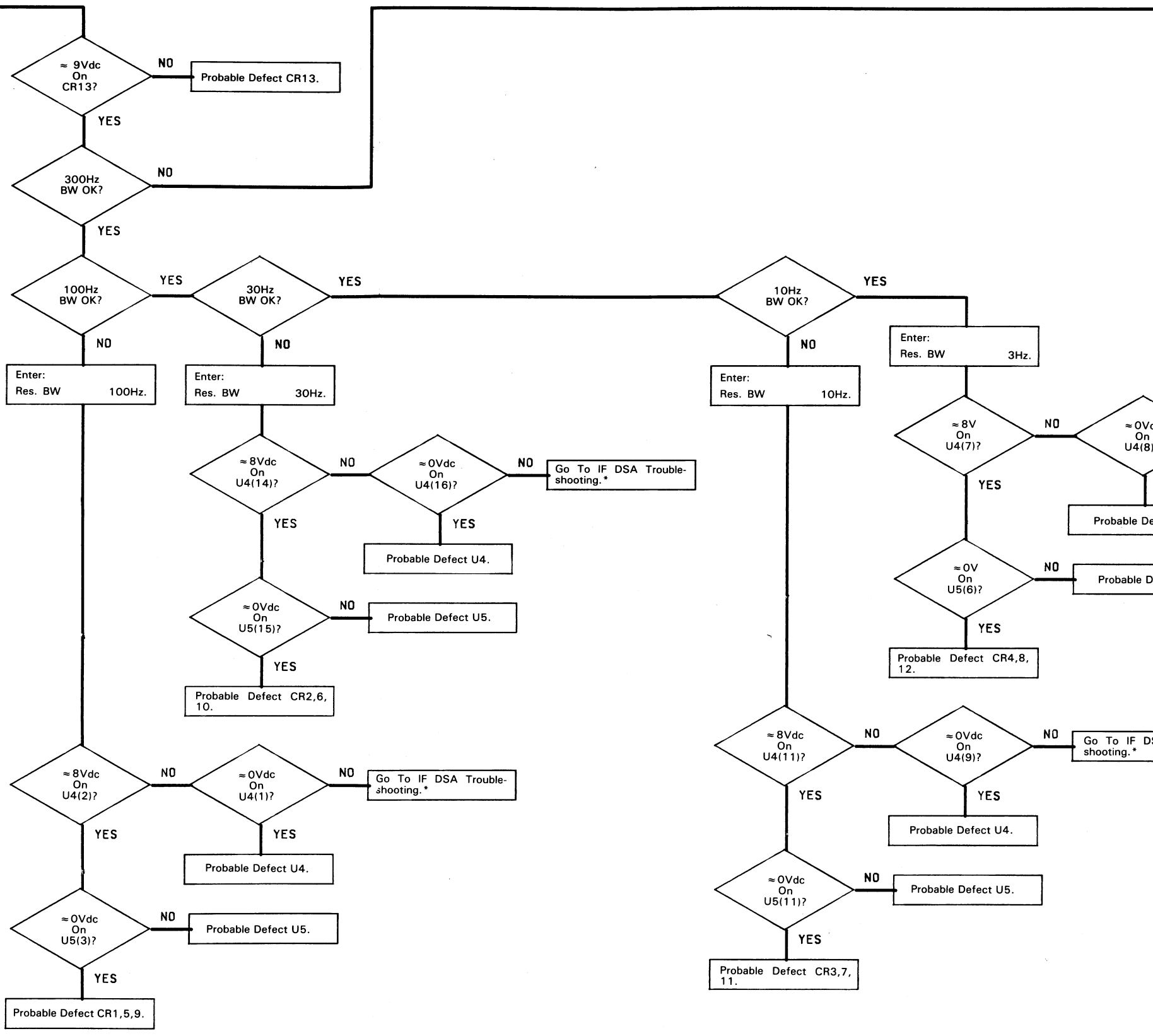


**Figure 11-A-3-18**

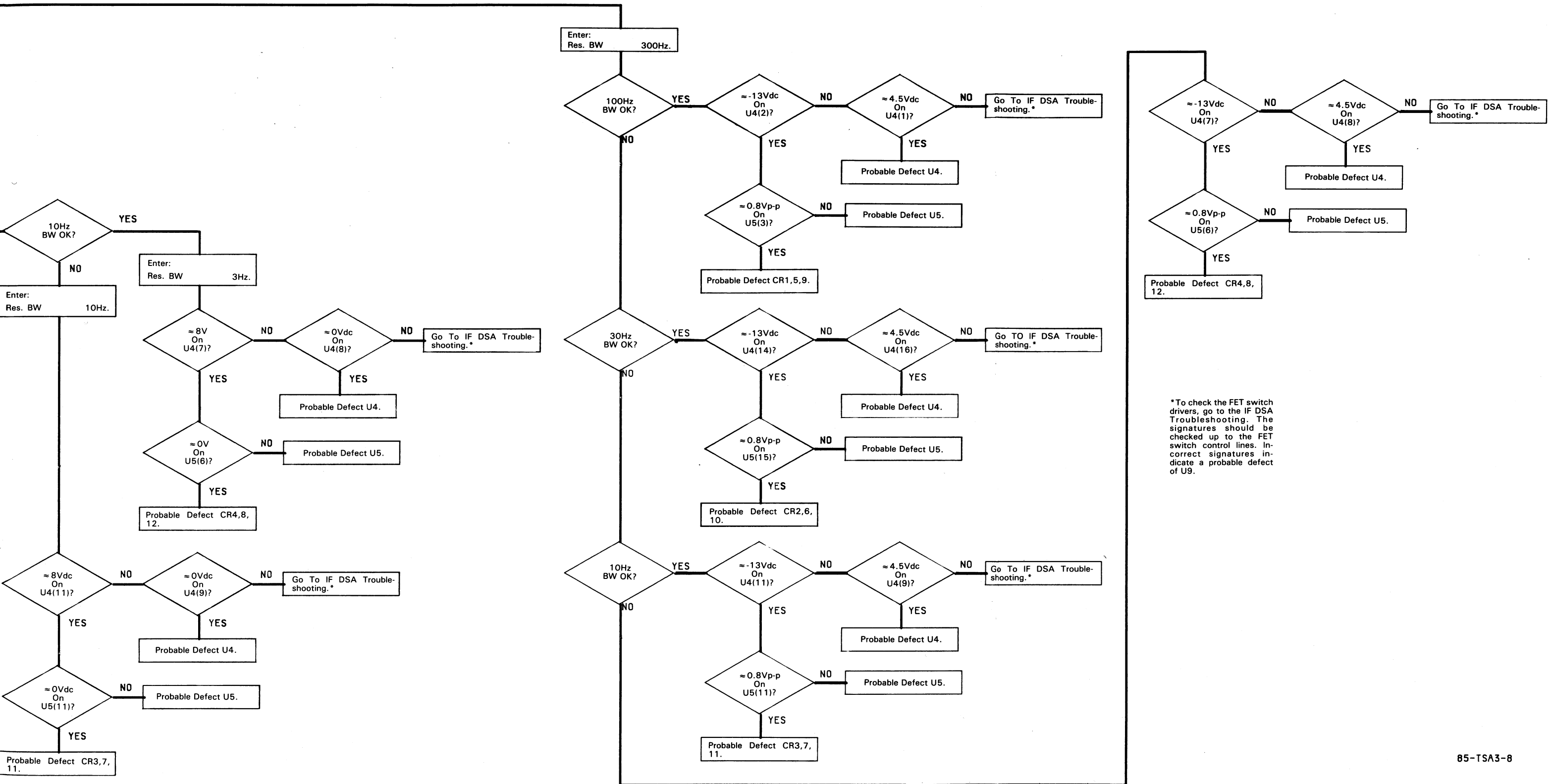




**NOTE**  
 The filter skirts will be wider than those shown in Figure 11-A-3-14 thru 18 when A17J4 or J5 are in the "T" position.

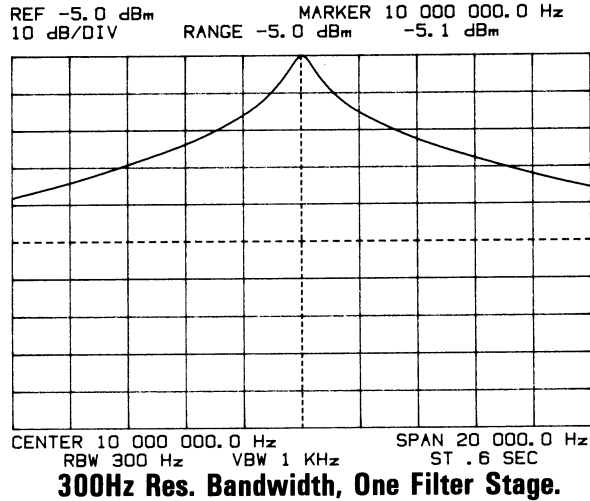




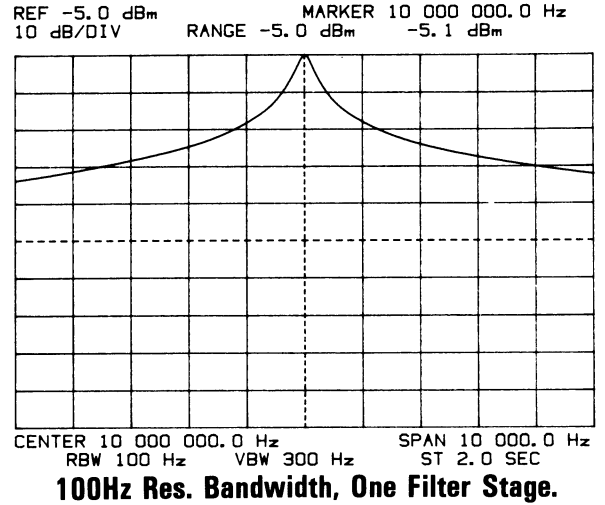


\*To check the FET switch drivers, go to the IF DSA Troubleshooting. The signatures should be checked up to the FET switch control lines. Incorrect signatures indicate a probable defect of U9.

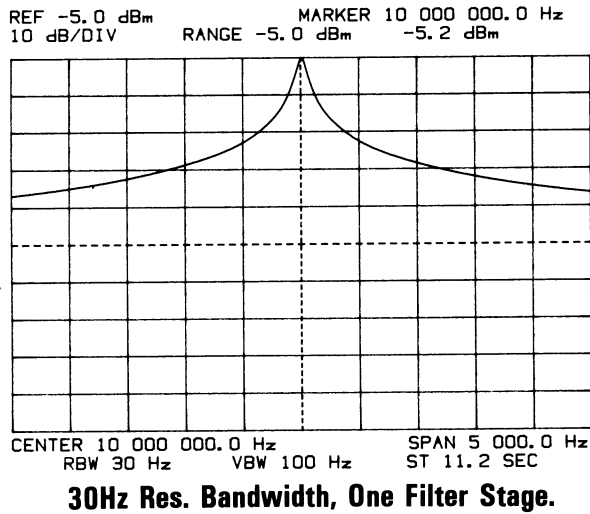
**Figure 11-A-3-21**



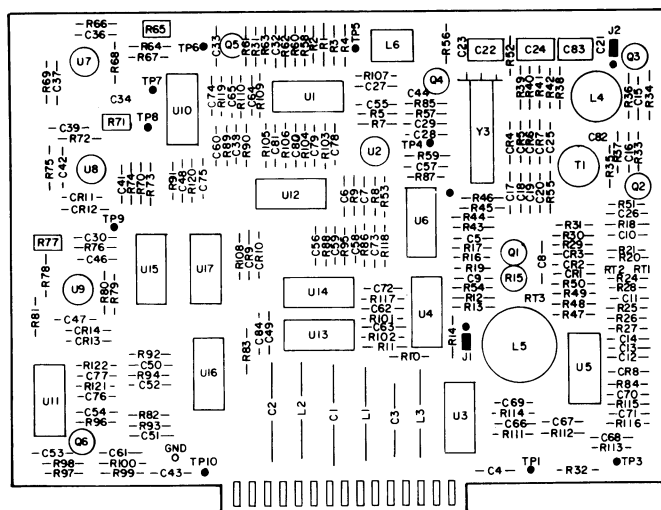
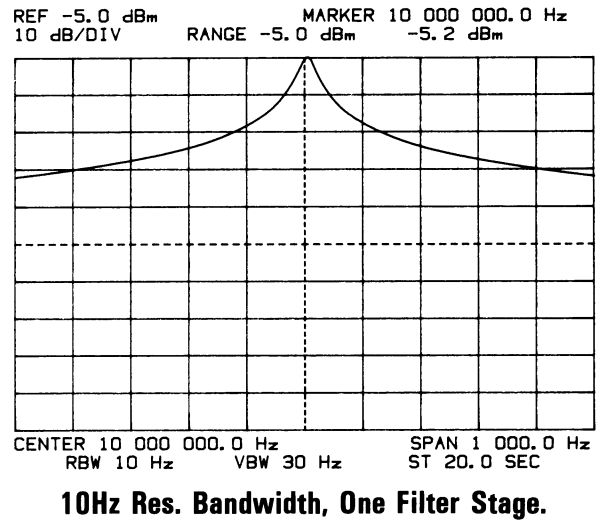
**Figure 11-A-3-22**



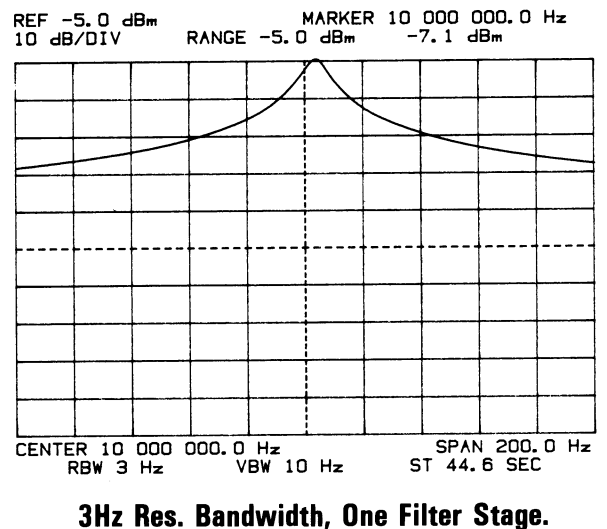
**Figure 11-A-3-23**



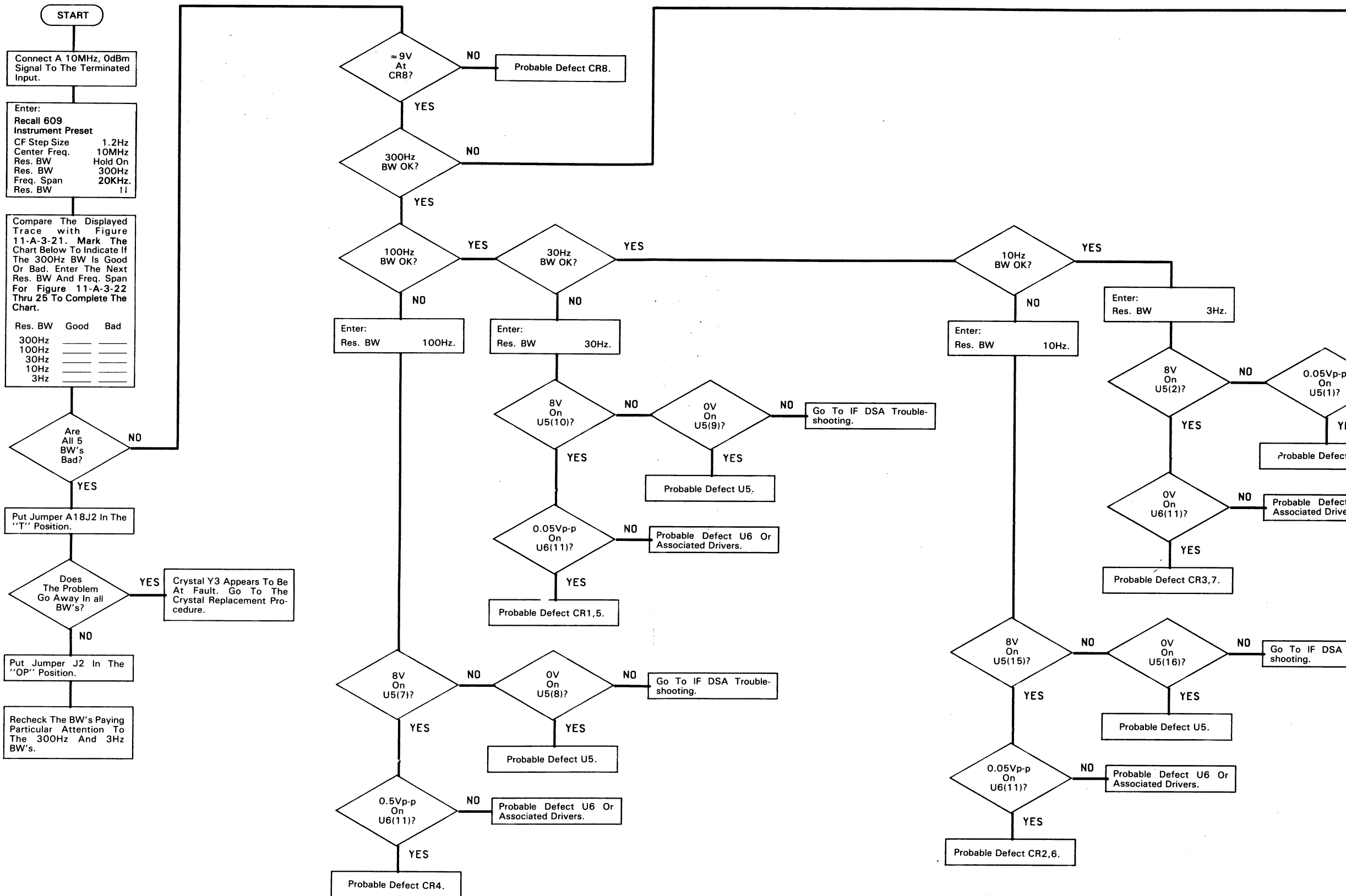
**Figure 11-A-3-24**

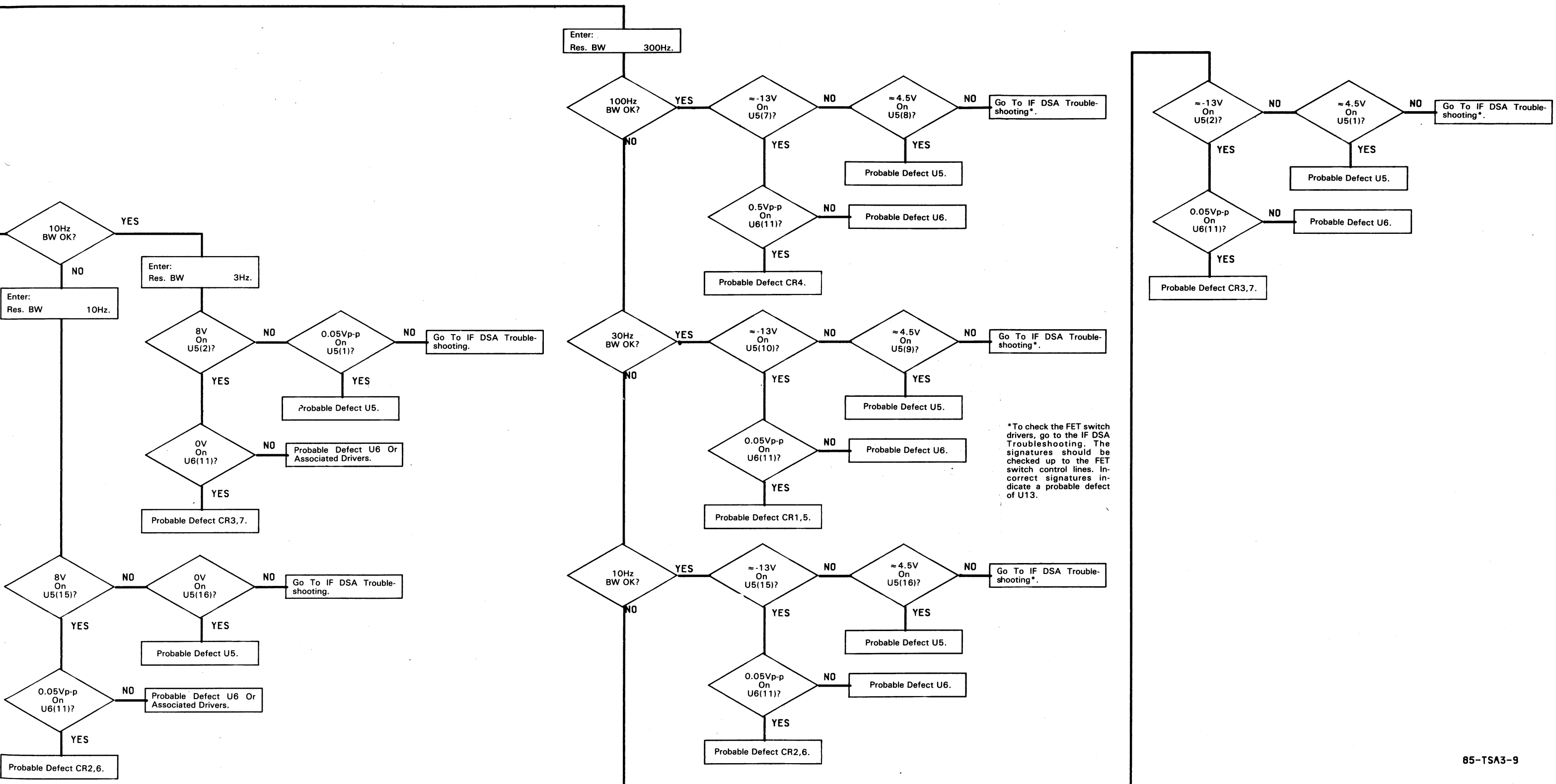


**Figure 11-A-3-25**

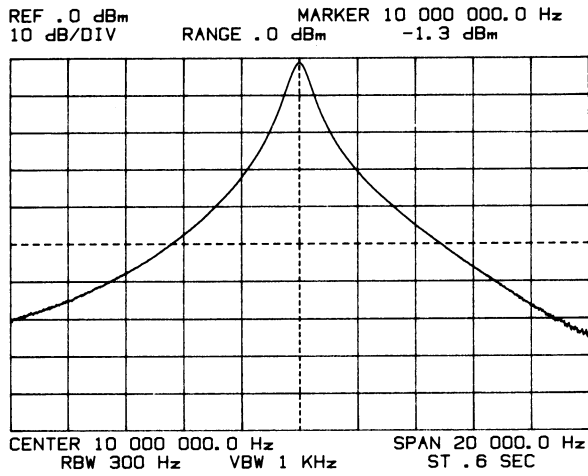


A18  
 03585-66518

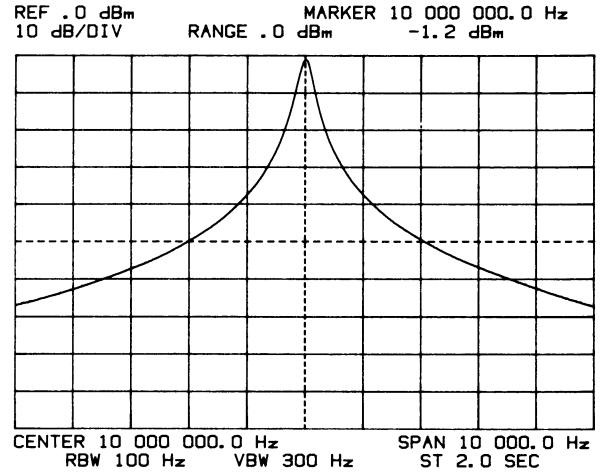




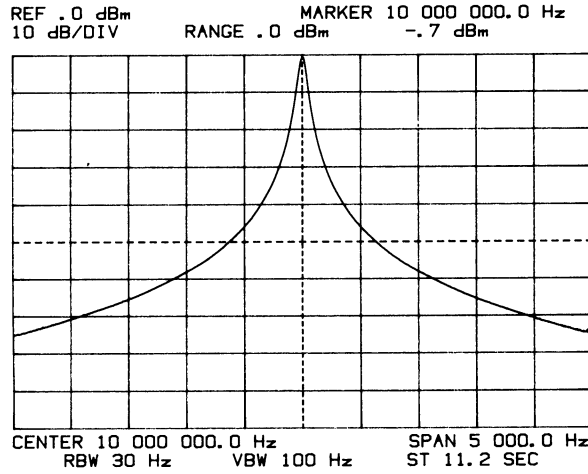
**Figure 11-A-3-14**



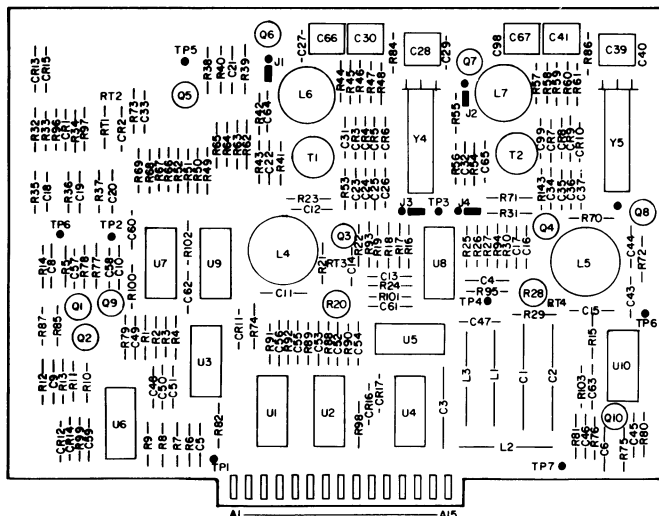
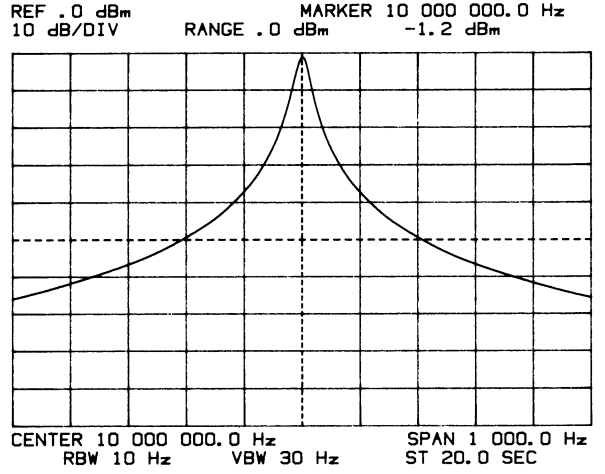
**Figure 11-A-3-15**



**Figure 11-A-3-16**

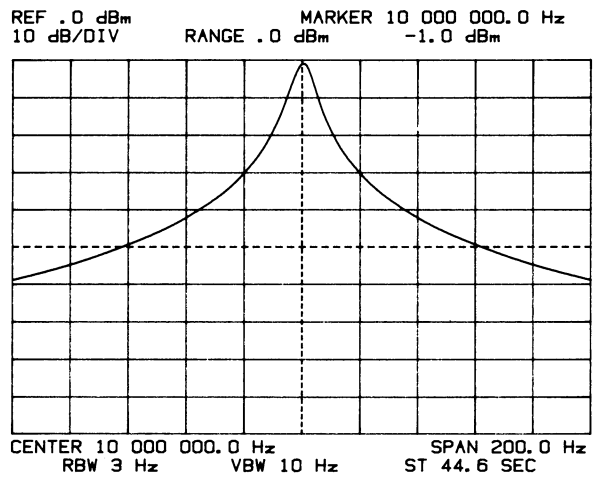


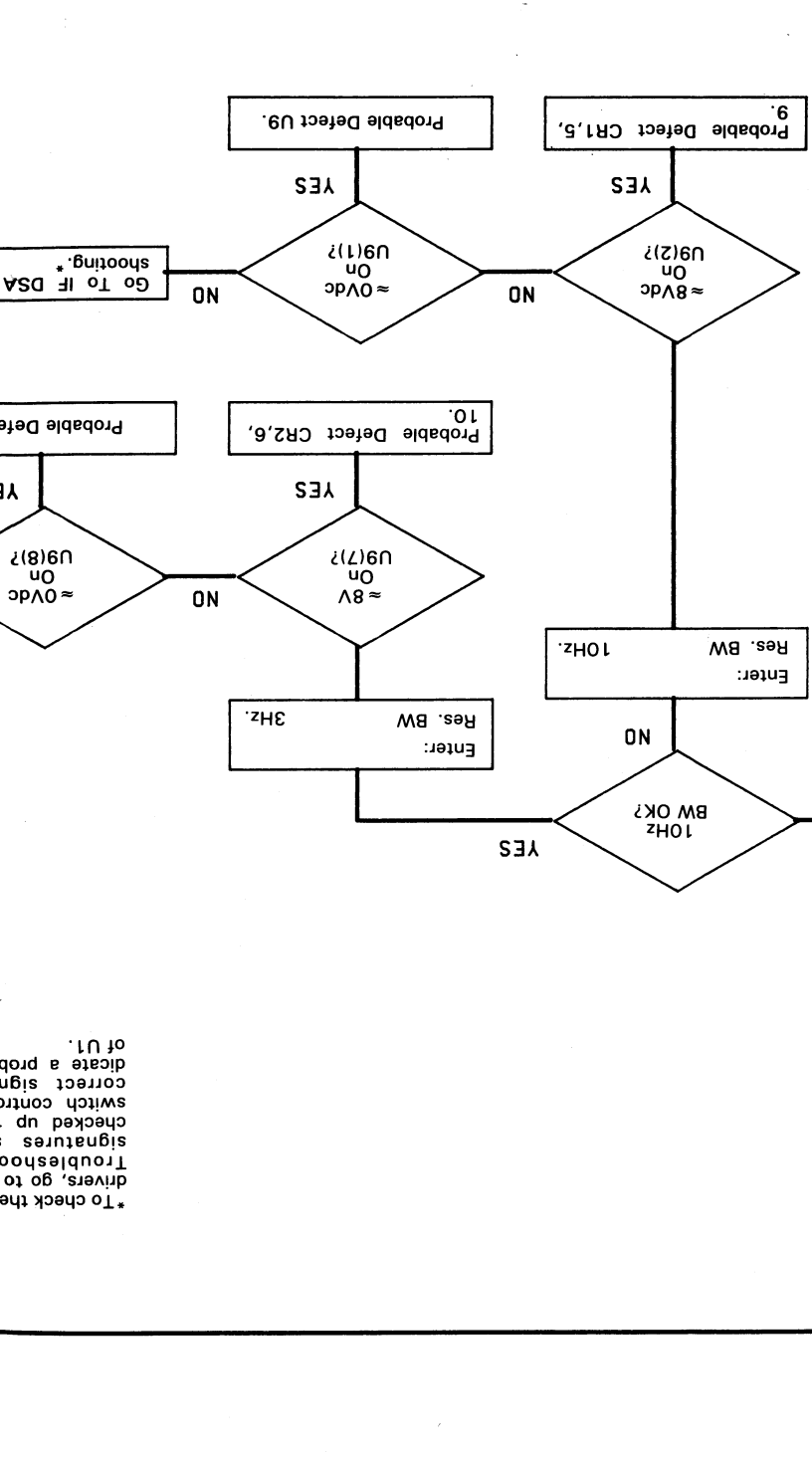
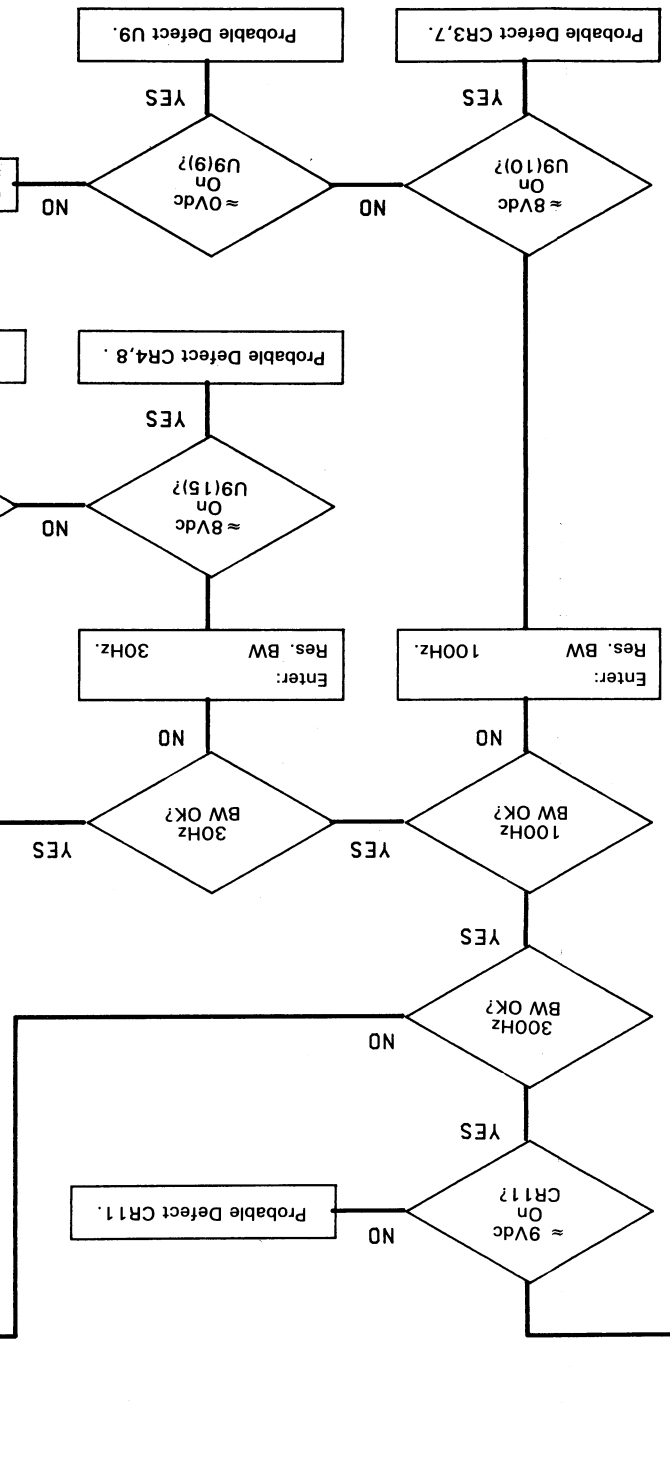
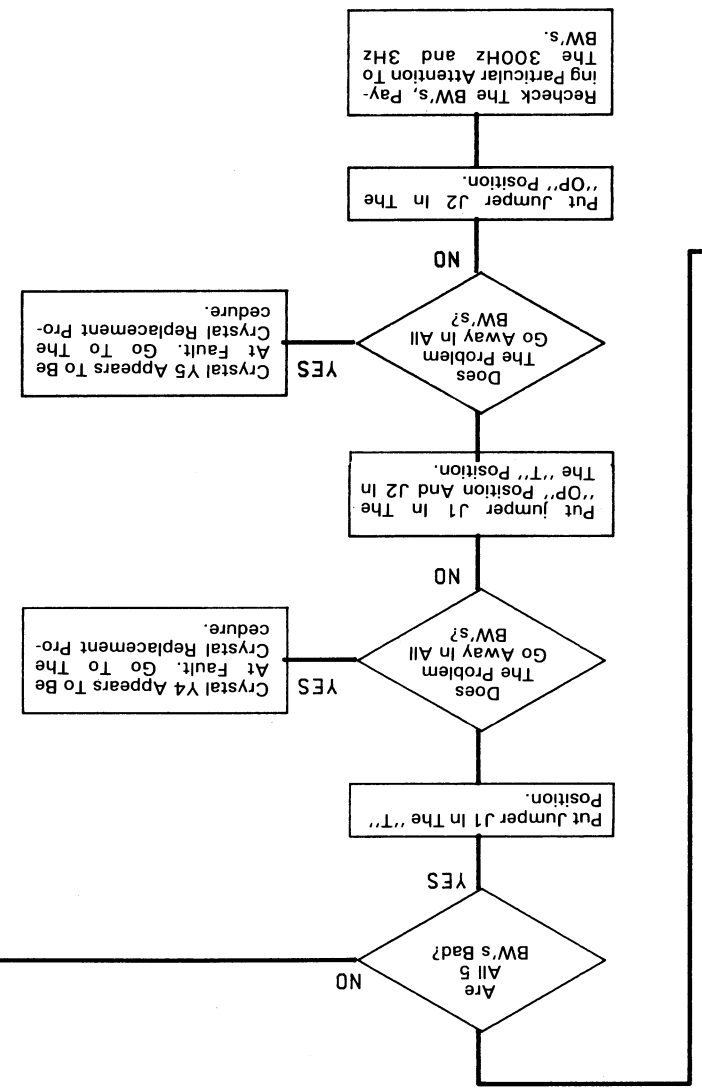
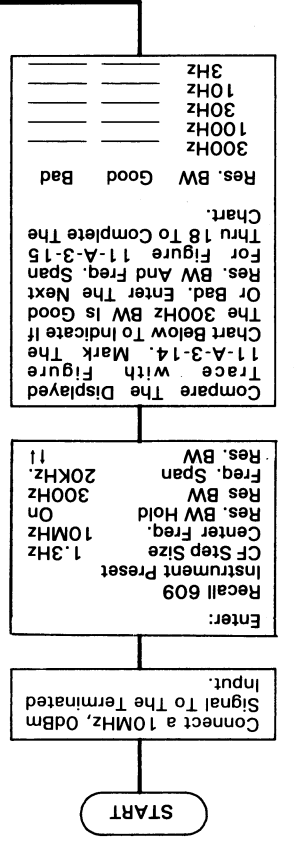
**Figure 11-A-3-17**



A19  
 03585-66519

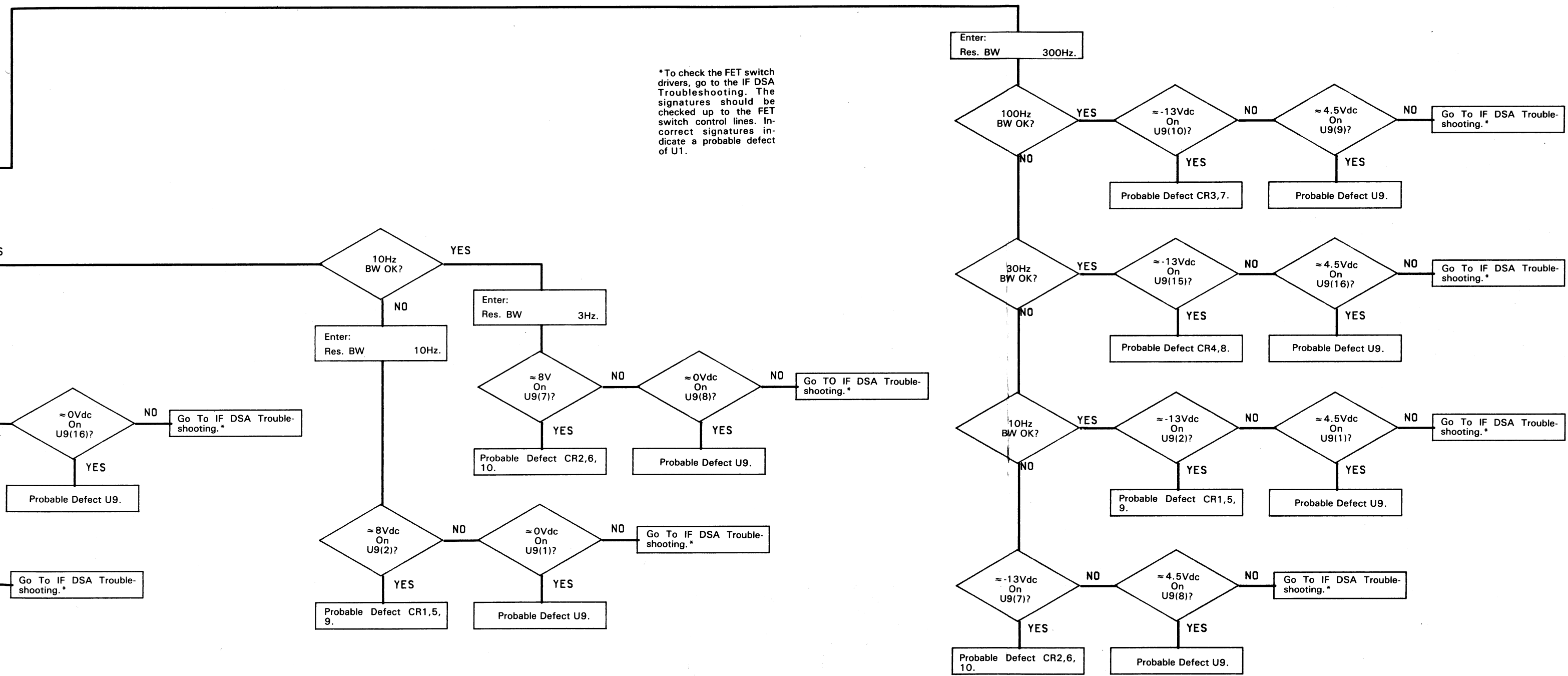
**Figure 11-A-3-18**

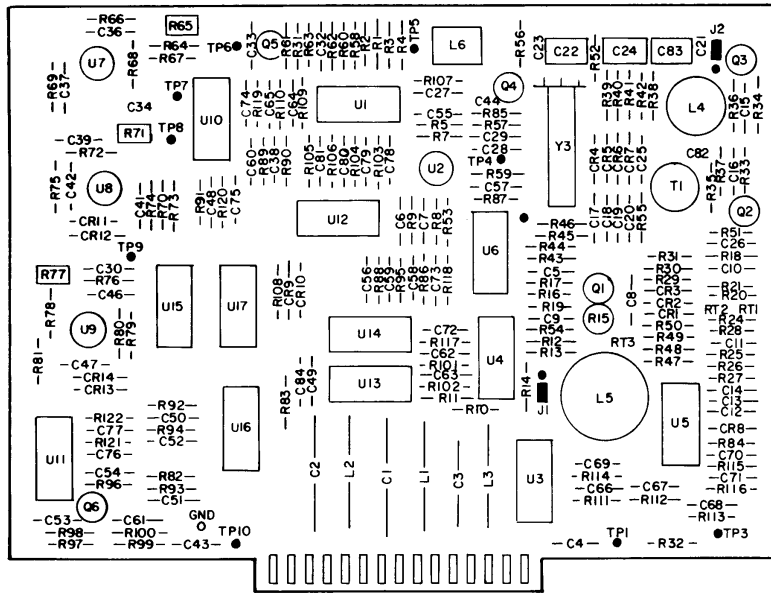




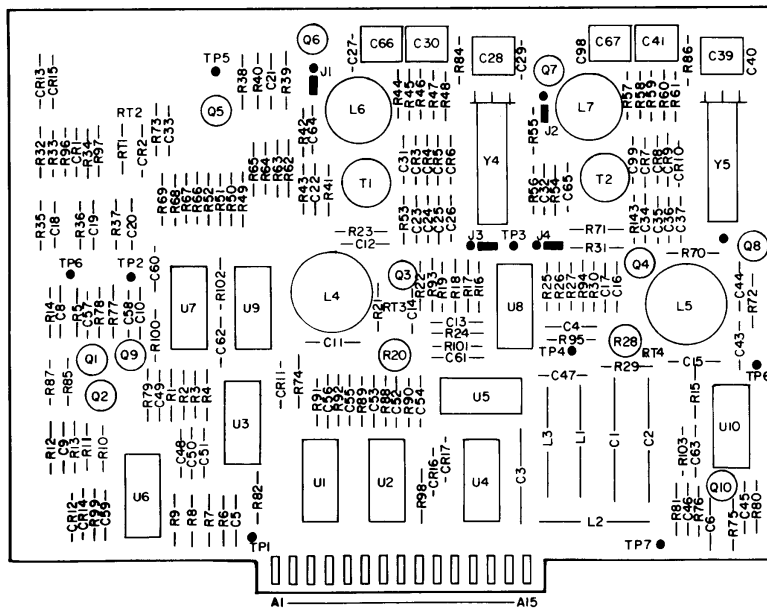
\* To check the drivers, go to Troubleshooting signatures. If checked up, correct switch correct sign indicate a problem of U1.

\*To check the FET switch drivers, go to the IF DSA Troubleshooting. The signatures should be checked up to the FET switch control lines. Incorrect signatures indicate a probable defect of U1.



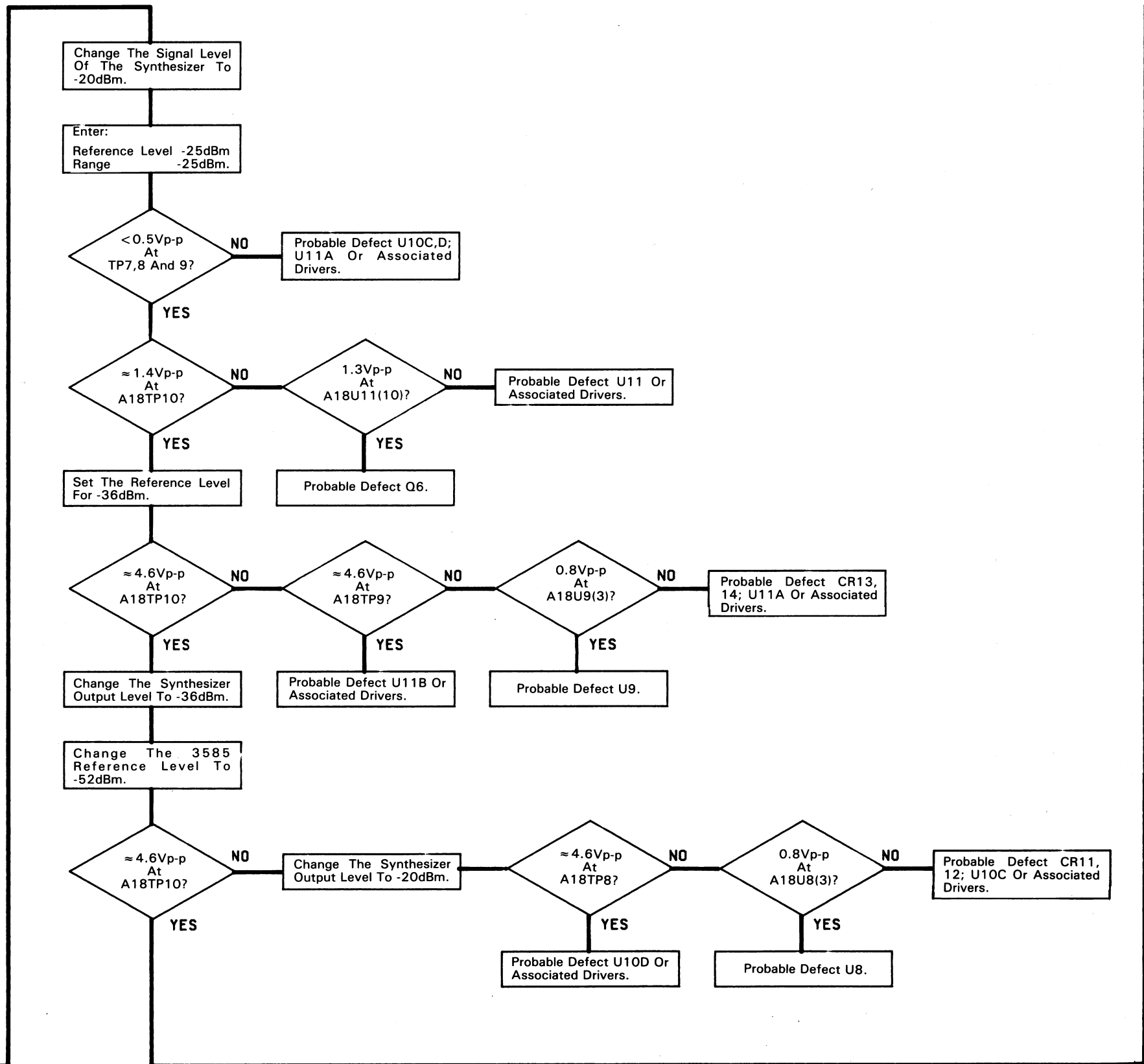
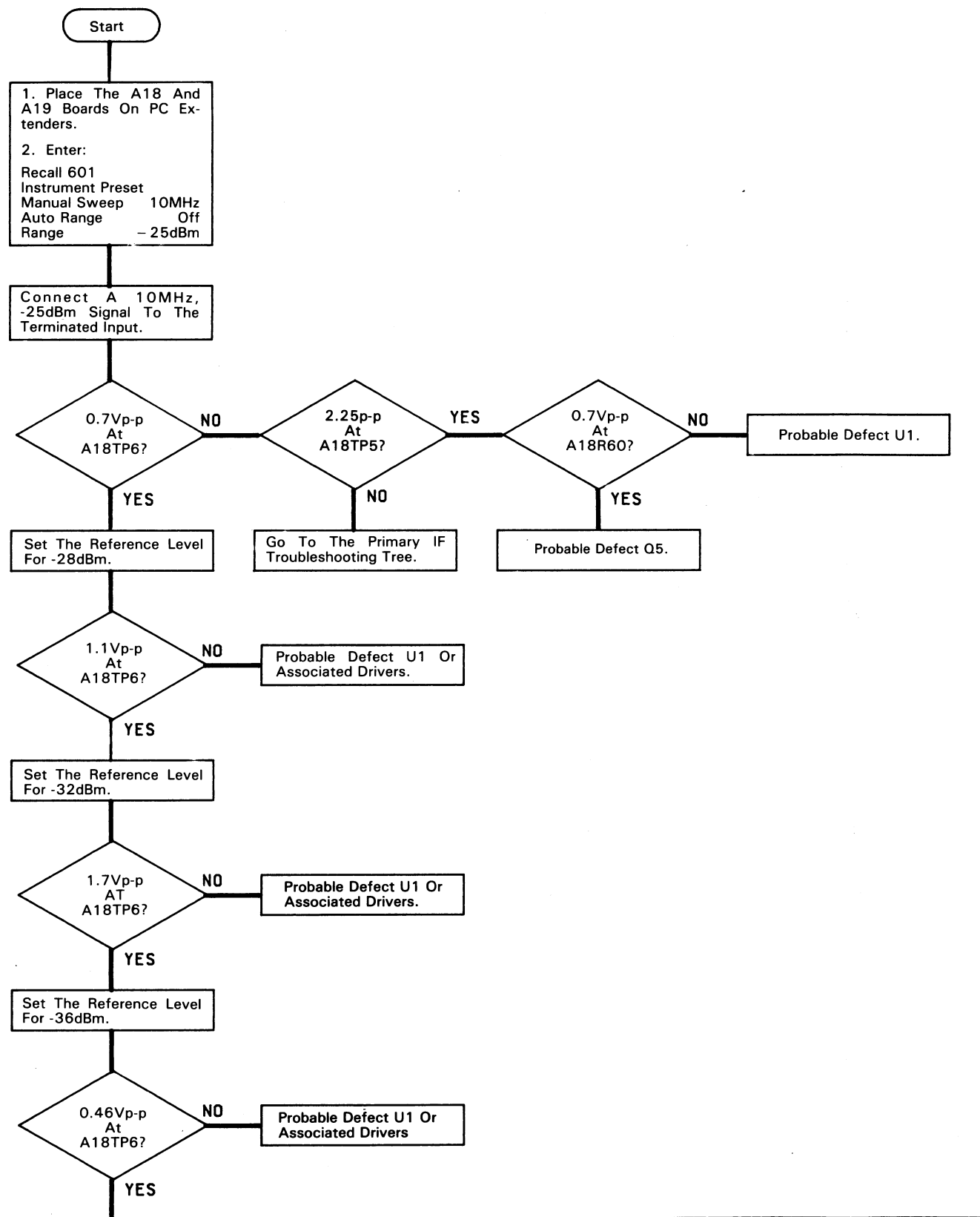


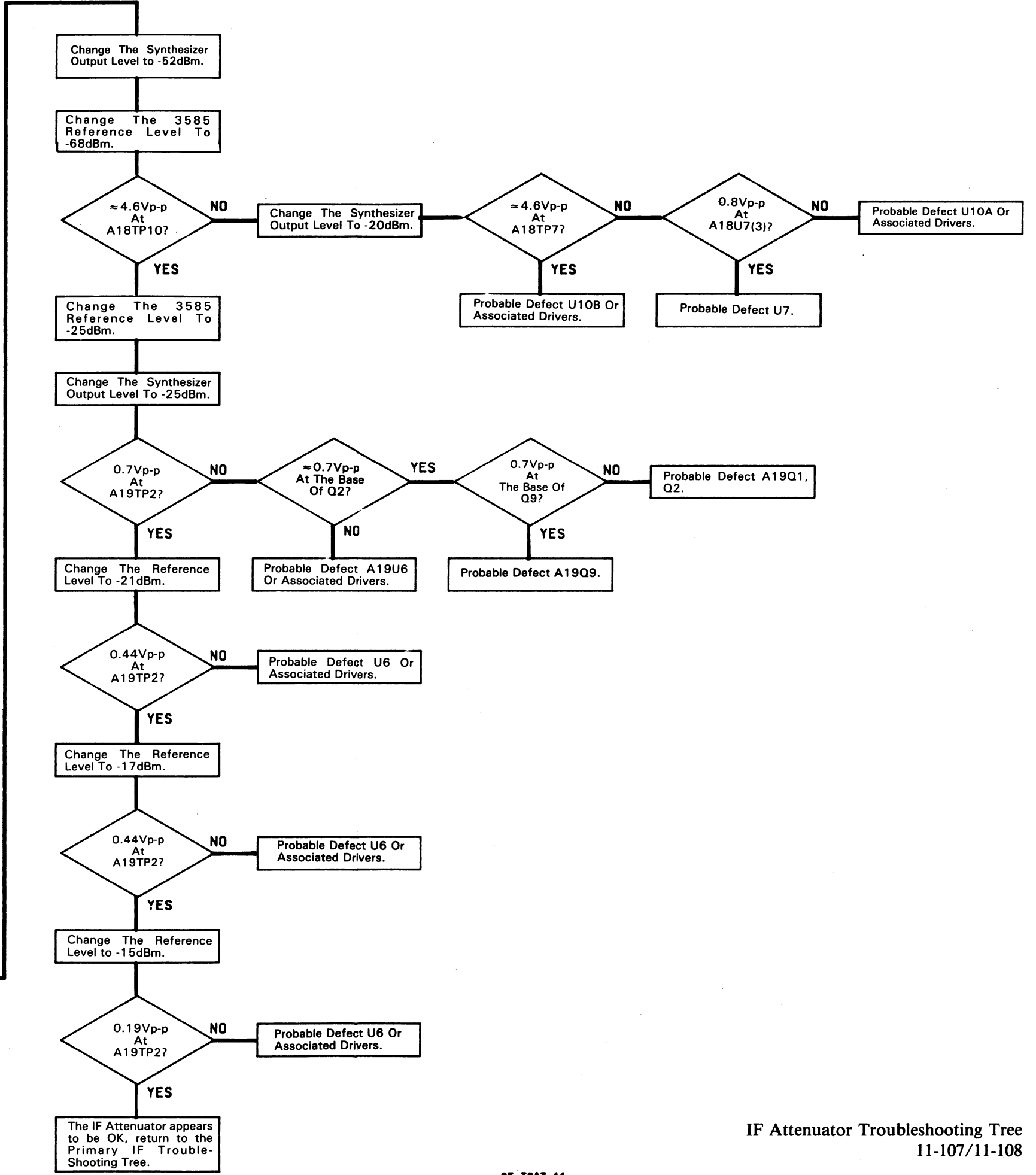
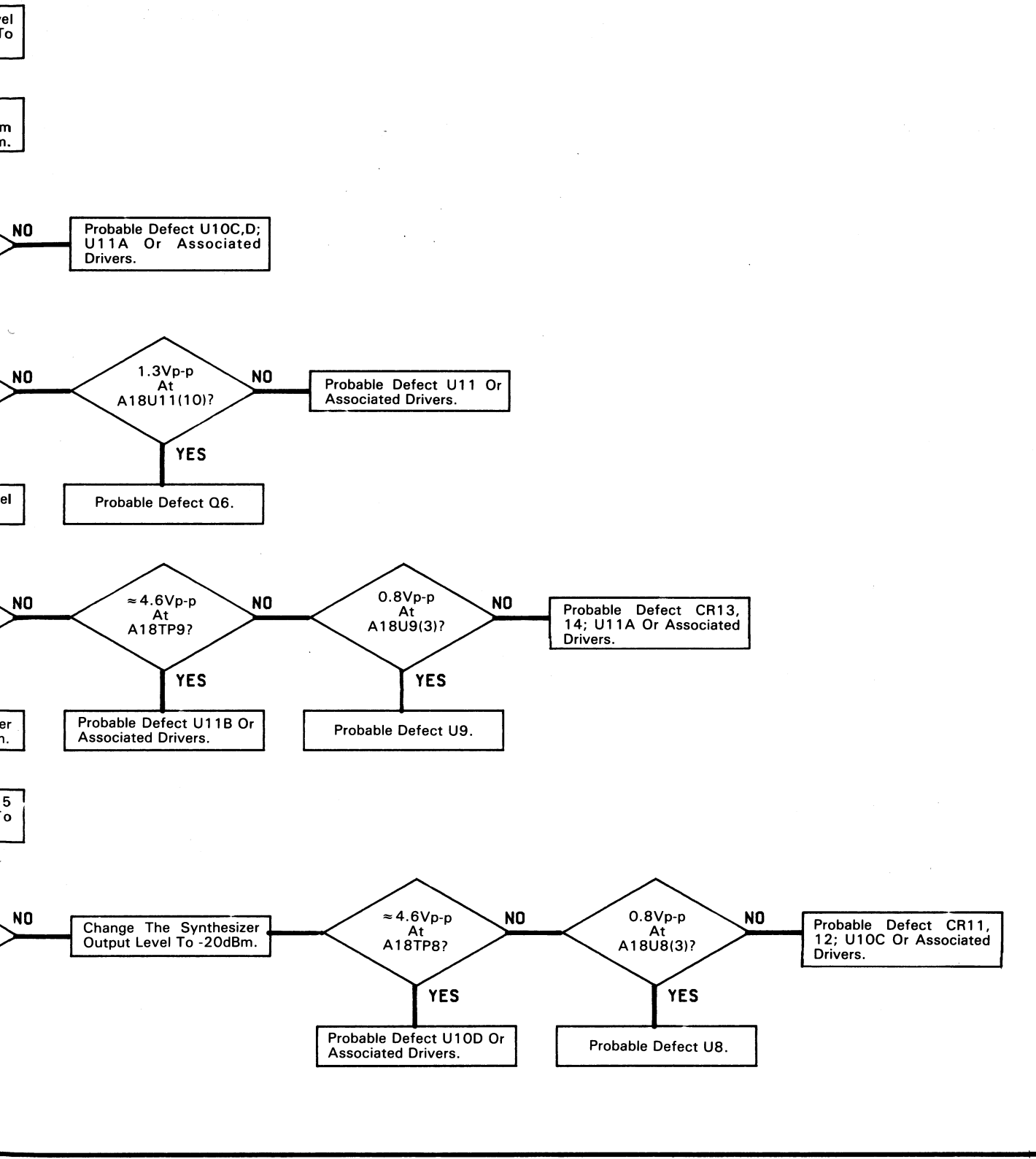
A18  
03585-66518



A19  
03585-66519







**Table 11-A-3-1. A17 FET Switch Truth Table**

Res. Bandwidth	Filter Path Selection						Bandwidth Selection											
	U2			U6			U3				U4				U5			
	(1)	(8)	(9)	(1)	(9)	(16)	(1)	(8)	(9)	(16)	(1)	(8)	(9)	(16)	(1)	(8)	(9)	(16)
30KHz	H	H	L	H	H	L	H	H	H	H	H	H	H	H	H	H	H	H
10KHz	H	L	H	L	H	H	L	H	H	L	H	H	H	H	H	H	H	H
3KHz	H	L	H	L	H	H	H	L	L	H	H	H	H	H	H	H	H	H
1KHz	H	L	H	L	H	H	H	H	H	H	H	H	H	H	H	H	H	H
300Hz	L	H	H	H	L	H	H	H	H	H	H	H	H	H	H	H	H	H
100Hz	L	H	H	H	L	H	H	H	H	L	H	H	H	H	L	H	H	H
30Hz	L	H	H	H	L	H	H	H	H	H	H	H	L	H	H	H	H	L
10Hz	L	H	H	H	L	H	H	H	H	H	H	L	H	H	H	H	L	H
3Hz	L	H	H	H	L	H	H	H	H	H	L	H	H	H	H	L	H	H

H = 3.5V to 5V  
L = 0V to 0.6V

**Table 11-A-3-2. A18 FET Switch Truth Table**

Res. Bandwidth	Filter Path Selection						Bandwidth Selection									
	U3			U6			U4		U5				U6			
	(1)	(8)	(16)	(1)	(8)	(16)	(9)	(16)	(1)	(8)	(9)	(16)	(9)			
30KHz	L	H	H	H	L	H	H	H	H	H	H	H	H			
10KHz	H	L	H	L	H	H	L	H	H	H	H	H	H			
3KHz	H	L	H	L	H	H	H	L	H	H	H	H	H			
1KHz	H	L	H	L	H	H	H	H	H	H	H	H	H			
300Hz	H	H	L	H	H	L	H	H	H	H	H	H	H			
100Hz	H	H	L	H	H	L	H	H	H	L	H	H	H			
30Hz	H	H	L	H	H	L	H	H	H	H	L	H	L			
10Hz	H	H	L	H	H	L	H	H	H	H	H	L	L			
3Hz	H	H	L	H	H	L	H	H	L	H	H	H	L			

Reference Level	4dB/Step Attenuator U1				16dB Gain Steps							
	(1)	(8)	(9)	(16)	U10				U11			
	(1)	(8)	(9)	(16)	(1)	(8)	(9)	(16)	(1)	(8)	(9)	(16)
-25dBm	H	L	H	H	H	H	H	H	H	H	L	L
-28dBm	H	H	H	L	H	H	H	H	H	H	L	L
-32dBm	H	H	L	H	H	H	H	H	H	H	L	L
-36dBm	L	H	H	H	H	H	H	H	L	L	H	H
-52dBm	L	H	H	H	H	L	L	H	H	L	H	H
-68dBm	L	H	H	H	L	L	H	L	H	L	H	H

H = 3.5V to 5V  
L = 0V to 0.6V

**Table 11-A-3-3. A19 FET Switch Truth Table**

Res. Bandwidth	Filter Path Selection						Bandwidth Selection							
	U7			U10			U8				U9			
	(1)	(8)	(16)	(1)	(8)	(16)	(1)	(8)	(9)	(16)	(1)	(8)	(9)	(16)
30KHz	H	H	L	L	H	H	H	H	H	H	H	H	H	H
10KHz	H	L	H	H	L	H	H	L	L	H	H	H	H	H
3KHz	H	L	H	H	L	H	L	H	H	L	H	H	H	H
1KHz	H	L	H	H	L	H	H	H	H	H	H	H	H	H
300Hz	L	H	H	H	H	L	H	H	H	H	H	H	H	H
100Hz	L	H	H	H	H	L	H	H	H	H	L	H	H	H
30Hz	L	H	H	H	H	L	H	H	H	H	H	L	H	H
10Hz	L	H	H	H	H	L	H	H	H	H	H	H	L	H
3Hz	L	H	H	H	H	L	H	H	H	H	H	H	H	L

Overdrive Attenuator FET Switch Truth Table (Instrument Test Mode 01).				
Reference Level	U6			
	(1)	(8)	(9)	(16)
-15dBm	H	H	H	L
-17dBm	H	H	L	H
-21dBm	L	H	H	H
-25dBm	H	L	H	H

H = 3.5V to 5  
L = 0V to 0.6V

**Test Procedure For IF Filters.**

1. Input a full scale signal to the Terminated input. For example, use a -25dBm signal with the Range and Reference Level equaling -25dBm.

**NOTE**

*When checking the IF section, it is best to use a synthesized signal source. This becomes essential when checking the Crystal Bandwidths.*

2. Using MANUAL ENTRY, enter the frequency of your signal source on the 3585A.
3. Select the desired RES. BW.
4. Signal tracing may now be done on any of the IF boards. Signal level should be slightly less than unity from the IF input to the IF output ( $\approx 1.5\text{dB}$  loss).

**Test Procedure For An Individual IF Stage.**

1. Input a full scale signal to the Terminated Input.
2. Place the A17, 18 or 19 board on a PC extender. Using Table 11-A-3-4, place the test jumper specified in the "test" position.

**Table 11-A-3-4. Jumper Test Positions**

To Test IF Filter Stage	Jumper To Place In Test Position	
	LC BW's	Crystal BW's
1	A17J3	A17J5
2	A17J2	A17J4
3	Jumpers bypass the entire third stage	
4	A19J4	A19J2
5	A19J3	A19J1



3. Enter:

Recall 609

Instrument Press

Center Frequency.....signal source frequency

CF Step Size.....1.1,1.2 or 1.3Hz (board # corresponds to the CF Step Size entry)

Res. BW.....  



Res. BW.....desired value

Res. BW Hold.....on

Frequency Span.....adjust to a value which will allow you to view either the 3dB or 60db points.

4. To change Res. BW, enter a new value for the Res. BW (remember to change the jumpers according to Table 11-A-3-4 if you change from LC to crystal BW's or vice versa). To check a different boards filters enter:

CF Step Size.....1.1,1.2 or 1.3Hz

Res. BW.....  

Res BW.....selected value

**A17-A19 Board Signature Analysis Tests.**

Equipment Required: Signature Analyzer (-hp- Model 5004A).

- a. Turn the instrument off.
- b. On the A45 board (tabs = Yellow/Green), set DIP test switches 2, 3 and 6 to the "on" (inboard) position. Verify that all other A45 test switches are in the "OPEN" (outboard) position.
- c. Connect the Signature Analyzer as follows:

START and STOP-----A45 TP1  
 CLOCK-----A45 TP2  
 GND-----A45 "GND" Test Point

- d. Set the Signature Analyzer controls as follows:

START----- / (out)  
 STOP----- \ (in)  
 CLOCK----- / (out)  
 HOLD----- off(out)  
 SELF TEST----- off(out)

- e. Turn the 3585A (and Signature Analyzer) on.
- f. At this point, the CRT screen should be blank, the front-panel LED indicators should be flashing and the red LED on the A45 board should be flashing.

To verify that your test setup is correct and the test routine is running properly, touch the Signature Analysis test probe to A17, 18 or 19, pin B13).

The signature should be "C2HH".

- g. Check for the following signatures at A17, 18 or 19, pins A3 thru A10:

A17,18 or 19 Pin	Signature
A3	68U1
A4	873H
A5	A14U
A6	U429
A7	4P86
A8	1430
A9	0593
A10	PF5F

- 1. If signatures are correct, go to Step h.

2. If signatures are incorrect, trouble is on I/O board (A45, Service Group C, DSA Test 11-C-3-1) or lines are being loaded by A15 board or A17-A19 IF boards.

**NOTE**

*The following procedures are for each individual IF board. Use the Signature Analysis Tests which pertain to the board you are troubleshooting.*

**A17 Board Signature Analysis Tests.**

- h. Check the following signatures:

IC# (pin)	Signature
U7( 7)	A165
U7( 9)	92H2
U7(12)	4U08
U1( 9)	6U07

1. If signatures are correct, no further Signature Analysis Tests are required. Disconnect the Signature Analyzer, set the A45 test switches to the "OPEN" position and correct the defect indicated on the A17 Troubleshooting Tree.
2. If signatures are incorrect, go to Step i.

**Further A17 Board Signature Analysis Tests.**

- Bandwidth Selector U9.

U7 Pin	Signature	Bandwidth
2	55C8	10KHz
5	AHF5	3KHz
7	6P28	30Hz
10	7146	3Hz
12	8A32	100Hz
15	5192	10Hz

- Filter (30KHz, LC or Xtal) Selector U1.

U1 Pin	Signature
7	U99U
10	FFUF
15	3U21

**A18 Board Signature Analysis Tests.**

h. Check the following signatures:

IC#(Pin)	Signature
U17( 7)	A165
U17( 9)	92H2
U17(11)	6PFP
U17(13)	AF09
U17(14)	7A32
U14( 9)	4PF1

1. If signatures are correct, no further Signature Analysis Tests are required. Disconnect the Signature Analyzer, set the A45 test switches to the "OPEN" position and correct the defect indicated on the A18 Troubleshooting Tree.

2. If signatures are incorrect, go to Step i.

Further A18 Board Signature Analysis Tests.

- Bandwidth Selector U13.

U13 Pin	Signature	Bandwidth
2	55C8	10KHz
5	AHF5	3KHz
7	6P28	30Hz
10	7146	3Hz
12	8A32	100Hz
15	5192	10Hz

- Filter (30KHz, LC or Xtal) Selector U14.

U14 Pin	Signature
7	6767
10	3C3C
12	H9HC
15	FPH8

- 4dB Step Attenuator Control U12.

U12 Pin	Signature	Attenuation
15	0A8C	0dB
10	AF2A	4dB
5	3ACO	8dB
7	H585	12dB



- 16dB Gain Step Control U15.

U15 Pin	Signature	Controlled Switch
2	HF20	U11B
5	P102	U11A
7	0813	U11C,D
10	409H	U10B
12	04P9	U10C
15	274U	U10A,D

**A19 Board Signature Analysis Tests.**

- h. Check the following signatures:

IC#(Pin)	Signature
U4( 7)	A165
U4( 9)	92H2
U4(10)	4746
U4(15)	543C
U2( 9)	6749

1. If signatures are correct, no further Signature Analysis Tests are required. Disconnect the Signature Analyzer, set the A45 test switches to the “OPEN” position and correct the defect indicated on the A19 Troubleshooting Tree.
2. If signatures are incorrect, go to Step i.

Further A19 Board signature Analysis Tests.

- Bandwidth Selector U1.

U1 Pin	Signature	Bandwidth
2	5192	10Hz
5	8A32	100Hz
7	7146	3Hz
10	6P28	30Hz
12	AHF5	3KHz
15	55C8	10KHz

- Filter (30KHz, LC or Xtal) Selector U2.

U2 Pin	Signature
2	9A13
7	4P68
10	P9FH

- Overdrive Attenuator Control U3.

U3 Pin	Signature	Attenuation
7	U24F	0dB
10	HP49	4dB
15	9U79	8dB
12	UCF9	12dB

- i. Check for the following signatures at A17U7, A18U17 or A19U4, pins 1 thru 4:

Pin	Signature
1	027F
2	0100
3	446C
4	3ACC

1. If signatures are correct, Probable Defect is U2.
2. If signatures are incorrect, Probable Defect is U1 (or U1 outputs being loaded by U2).

**CRYSTAL REPLACEMENT PROCEDURE Δ4**

- a. The five crystals used in the IF section (A17-19 boards) are a matched set. If a defective crystal is discovered all five crystals must be replaced with a new matched set (-hp- Part Number 03585-82501).
- b. When you receive your new set of crystals you will also receive a sheet similar to the one below:

Comprise Set #184		
XTAL Number	Pad Value (Ω)	-hp- Part Number
219A	97.6	0698-4402
111B	73.2	0698-4395
214A	73.2	0698-4395
76A	73.2	0698-4395
12A	84.5	0698-4397

**Figure 11-A-3-4. Crystal Data Sheet Example**

- c. Each set is given a number. Each crystal is also identified with a small, numbered sticker on the crystal body. This number corresponds with the “XTAL Number” column in Figure 11-A-3-4.
- d. Select a crystal from the new set. Using the sheet which you received with your crystal set, find the listed value of resistance required for that crystal. Table 11-A-3-5 lists the -hp-part numbers for the padding resistors used for the crystals.

**Table 11-A-3-5. Crystal Padding Resistors**

Resistor Value ±1%	-hp- Part Number
0	8150-3375
12.1	0757-0379
24.3	0757-0386
36.5	0757-0390
48.7	0698-4381
60.4	0698-4387
73.2	0698-4393
84.5	0698-4397
97.6	0698-4402
110.0	0757-0402

- e. When you have obtained the correct padding resistor for the new crystal, replace the old crystal and associated padding resistor. The crystals and their associated padding resistors are listed in Table 11-A-3-6.

**Table 11-A-3-6. Crystal and Padding Resistor Numbers**

<b>Crystal</b>	<b>Padding Resistor</b>
Y1	A17R96
Y2	A17R97
Y3	A18R52
Y4	A19R84
Y5	A19R86

- f. Once the new set of crystals are installed they must be adjusted in the manner outlined in Paragraph 5-9, Volume 2.

# SERVICE GROUP A-4 LOG AMPLIFIER

**Board No. A14**

**(Part Number 03585-66514)**

**INDEX:**

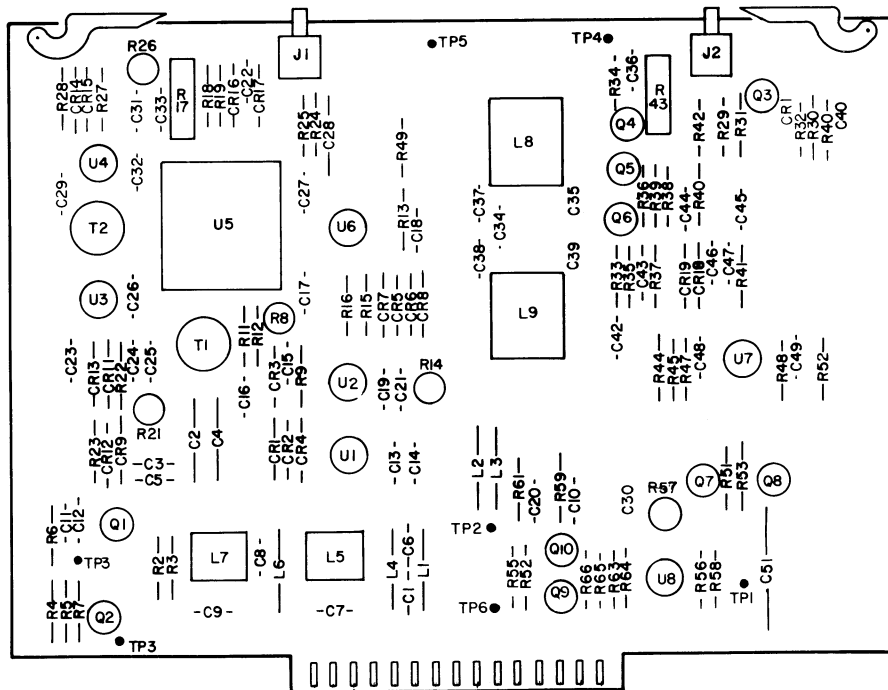
Title	Page
Log Amplifier (A14) Troubleshooting Tree .....	11-121/11-122

**ADJUSTMENTS:**

Component	Adjusted Parameter	Paragraph Location
A14L5	30KHz Filter	5-18
A14L7	30KHz Filter	5-18
A14R57	Log Amplifier Input Level	5-18
A14R17	- 10dB Log Linearity	5-18
A14R43	- 30dB Log Linearity	5-18
A14R8	- 50dB Log Linearity	5-18
A14R14	- 70dB Log Linearity	5-18
A14R21	- 90dB Log Linearity	5-18
A14R26	-100dB Log Linearity	5-18

**TROUBLESHOOTING NOTES:**

1. Do not adjust the Log Amplifier unless you have verified a misadjustment. All the adjustments for the A14-16 boards must be performed if the Log Amplifier is adjusted.



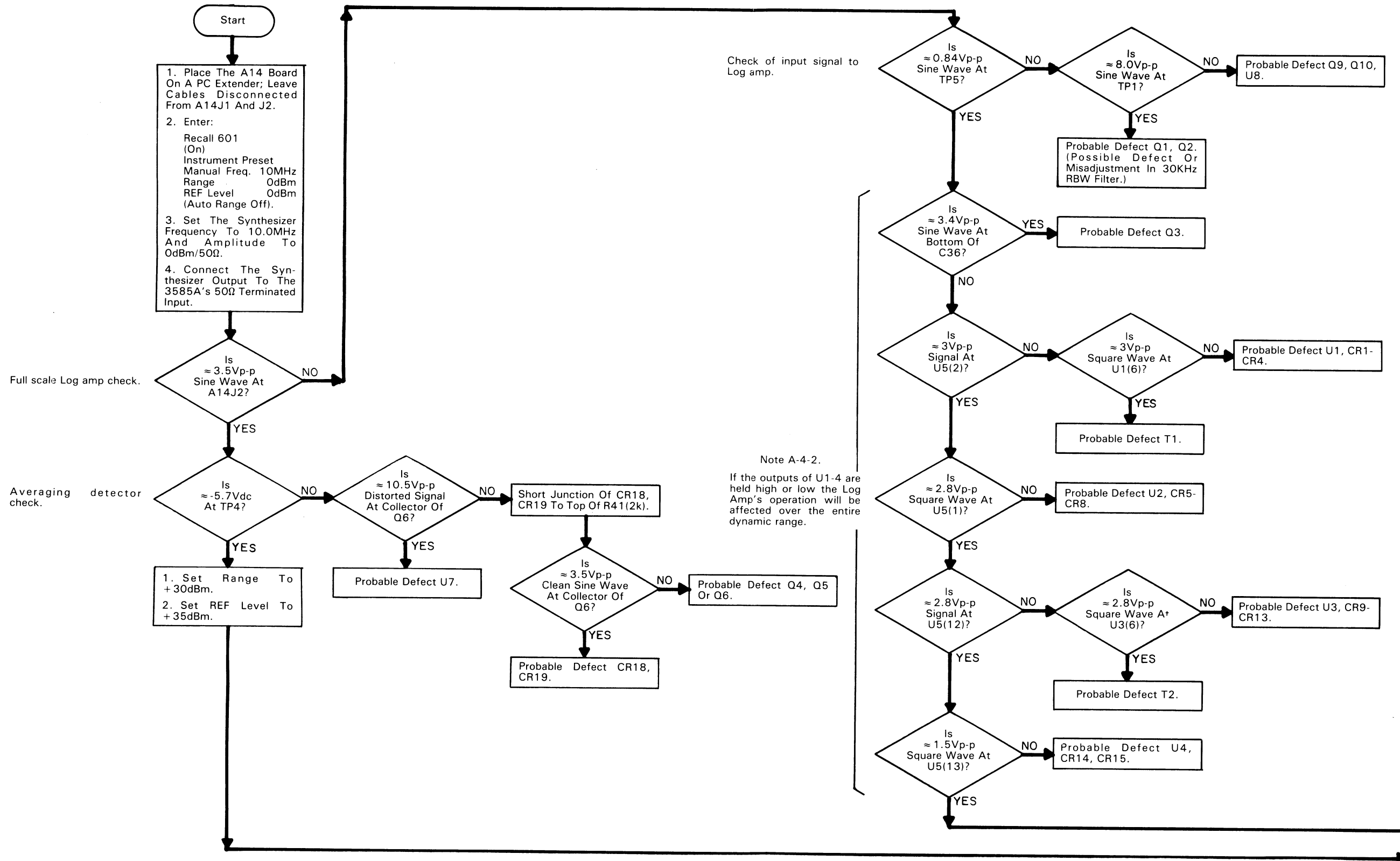
A14  
03585-66514

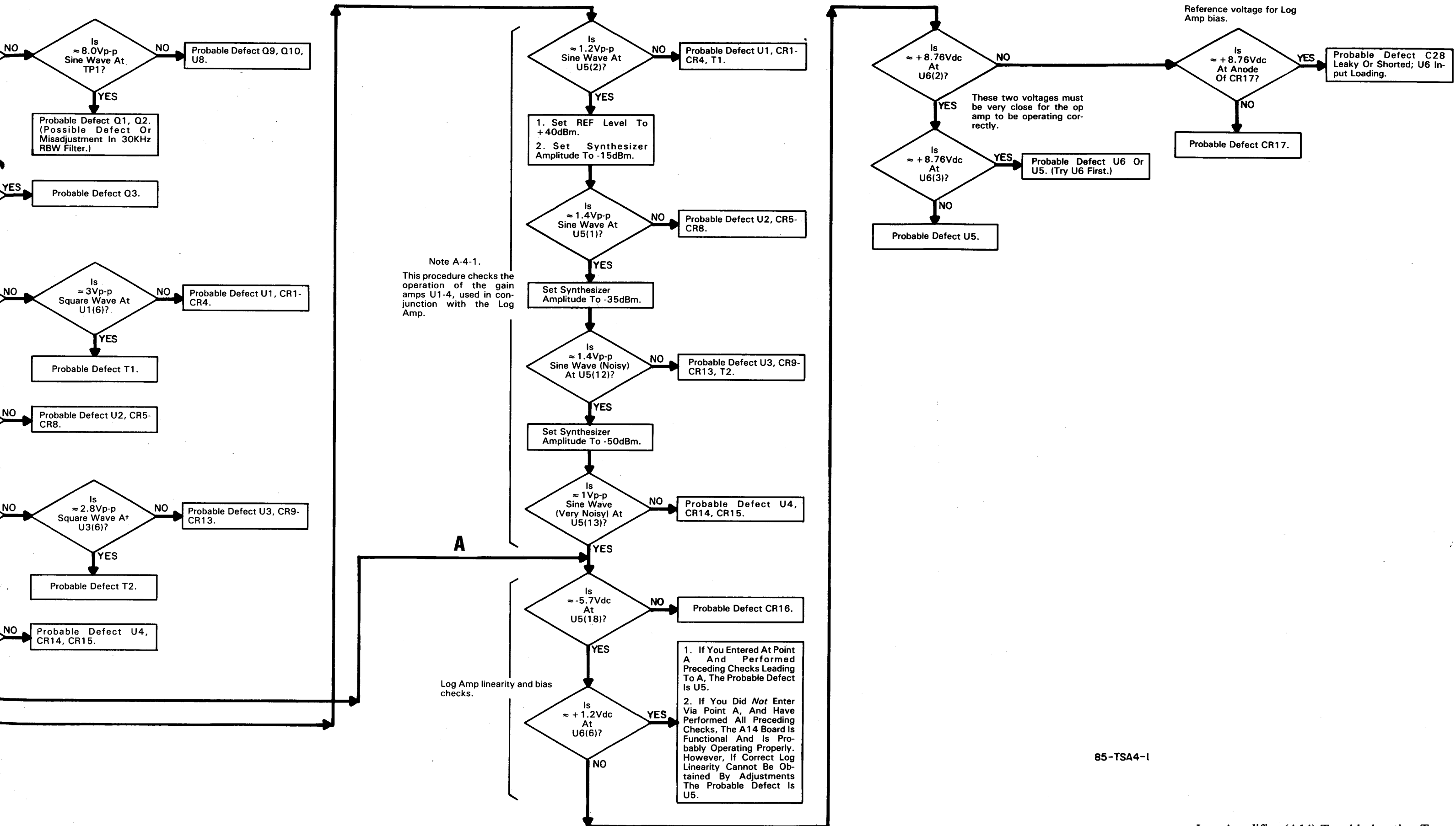
Full scale

Average check.

3886-B-16

Log Amp Board (A14) Troubleshooting.





85-TSA4-1



# SERVICE GROUP A-5

## VIDEO FILTER

Board No. A15

(Part Number 03585-66515)

### INDEX:

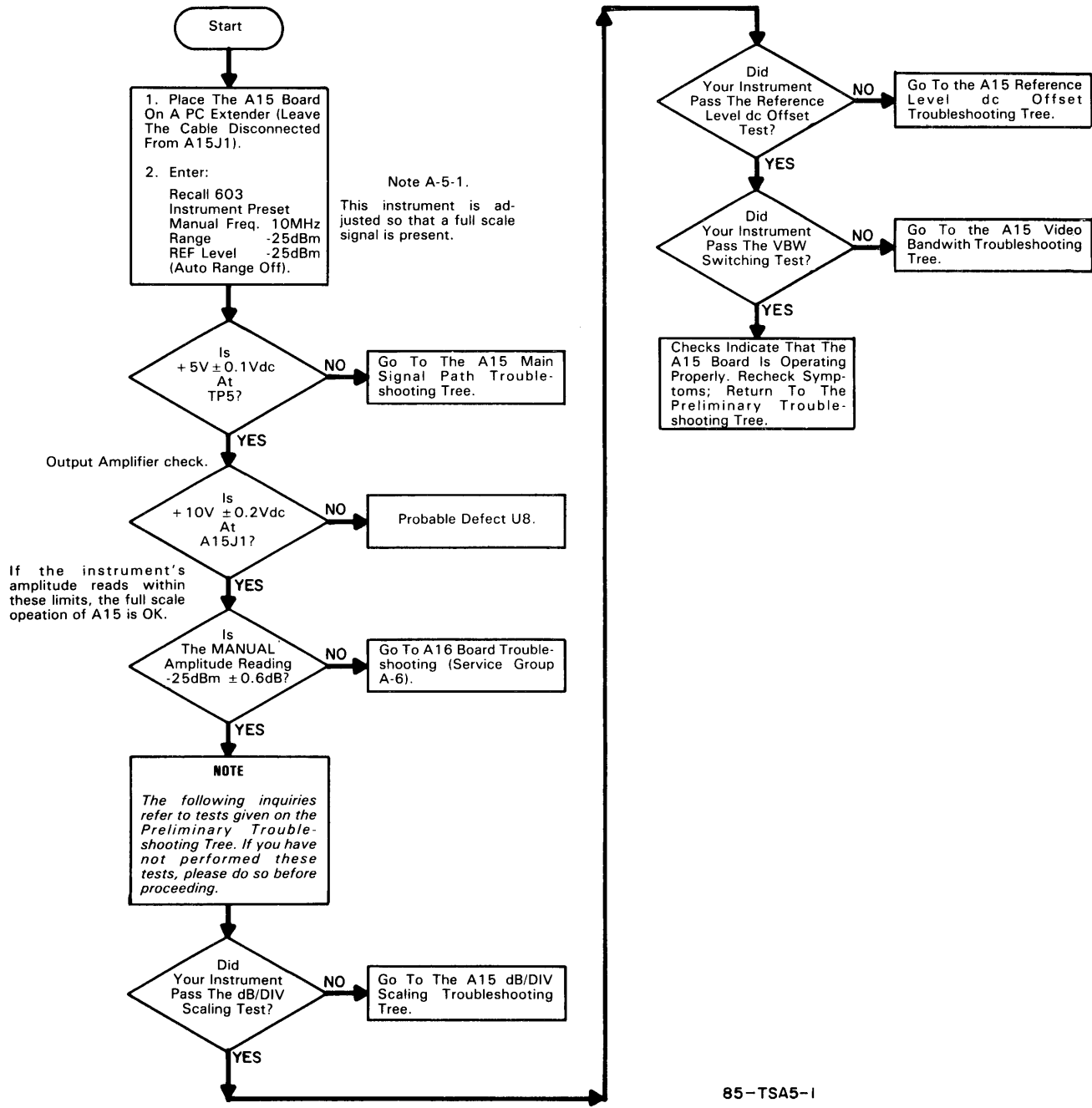
Title	Page
Video Filter (A15) Troubleshooting Tree.....	11-124
A15 Video Bandwidth Switching Troubleshooting Tree.....	11-125/11-126
A15 dB/DIV Scaling Troubleshooting Tree.....	11-127/11-128
A15 Main Signal Path Troubleshooting Tree.....	11-129/11-130
A15 Reference Level dc Offset Troubleshooting Tree.....	11-131/11-132
A15 Signature Analysis Tests.....	11-133

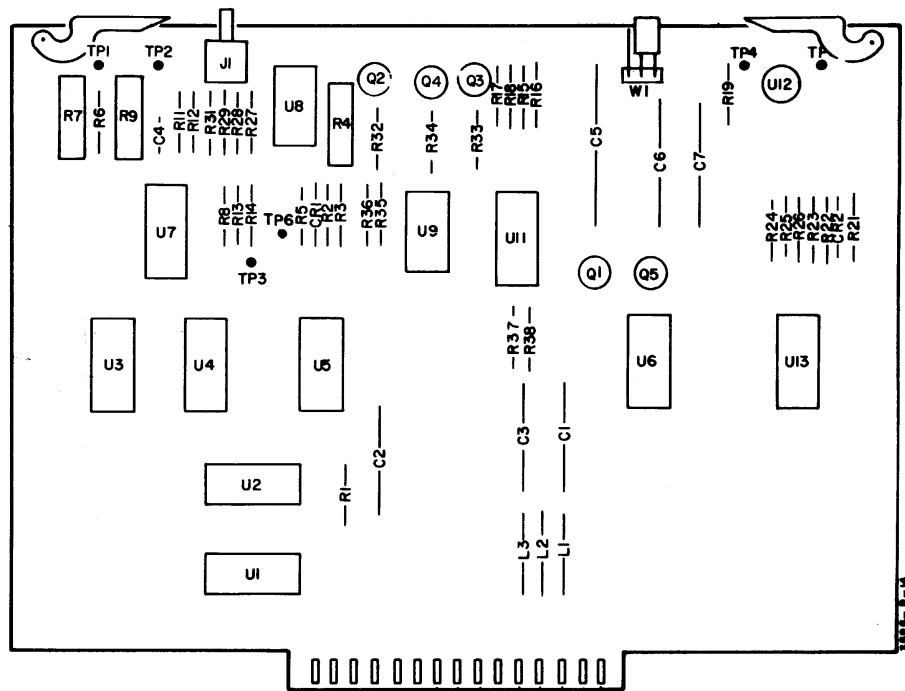
### ADJUSTMENTS:

Component	Adjusted Parameter	Paragraph Location
A15R4	5V Reference	5-16
A15R7	Top Of Screen Reference	5-16
A15R9	Reference Level dc Offset	5-16

### TROUBLESHOOTING NOTES:

None





A15  
03585-88515

Note A-5-5.  
These tests check the operation of the FET Switch drivers U9, 11.

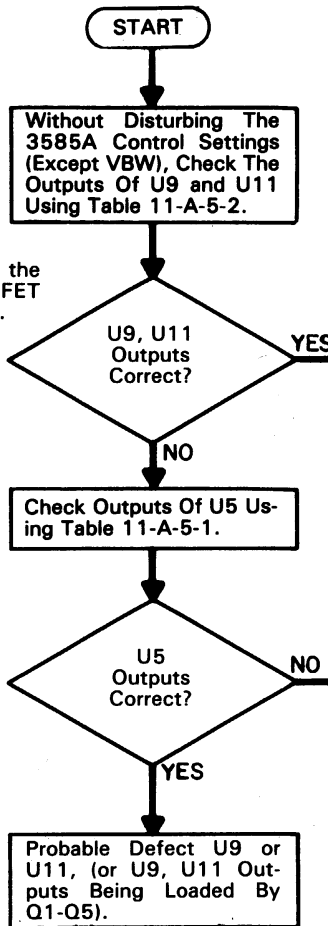


Table 11-A-5-1. U5 Output Checks

VBW	U5 Pin*				
	5	7	10	12	15
30kHz	H	H	L	H	H
10kHz	H	L	H	H	H
3kHz	L	H	H	H	H
1kHz	H	H	H	H	H
300Hz	H	L	H	H	L
100Hz	L	H	H	H	L
30Hz	H	H	H	H	L
10Hz	H	L	H	L	H
3Hz	L	H	H	L	H
1Hz	H	H	H	L	H

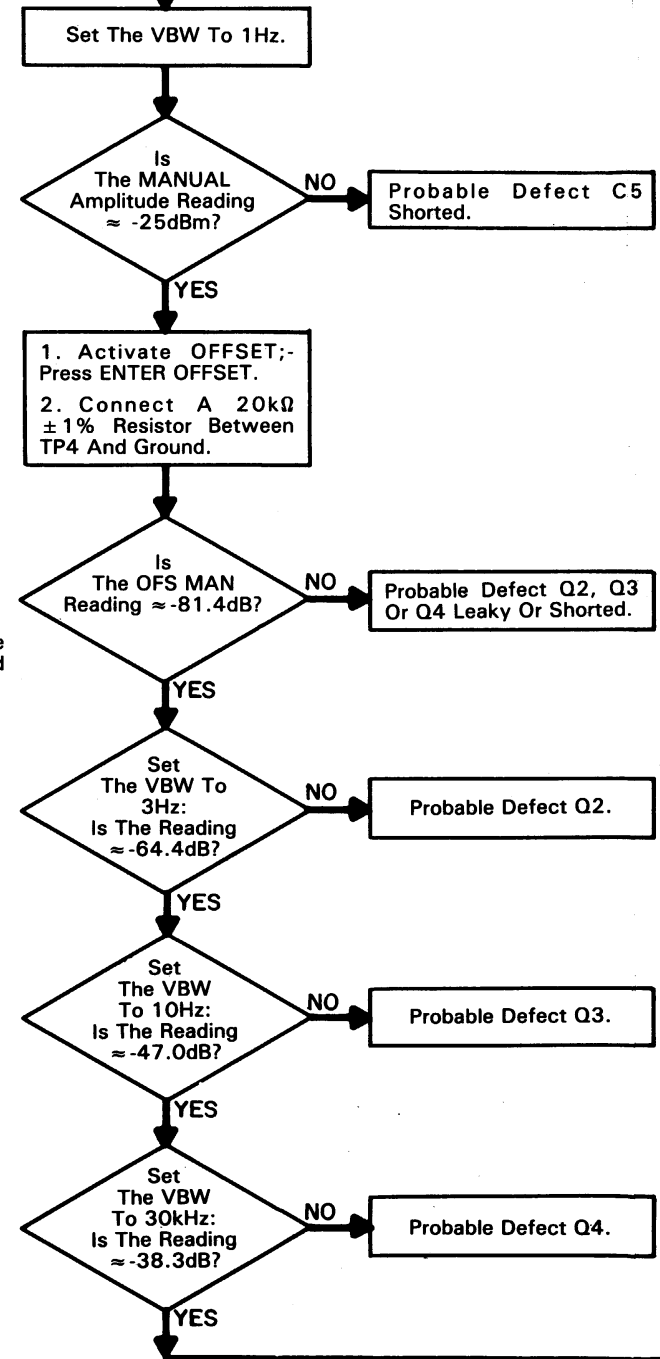
\*TTL: H = +3.5V to +5V;  
L = 0V to +0.6V

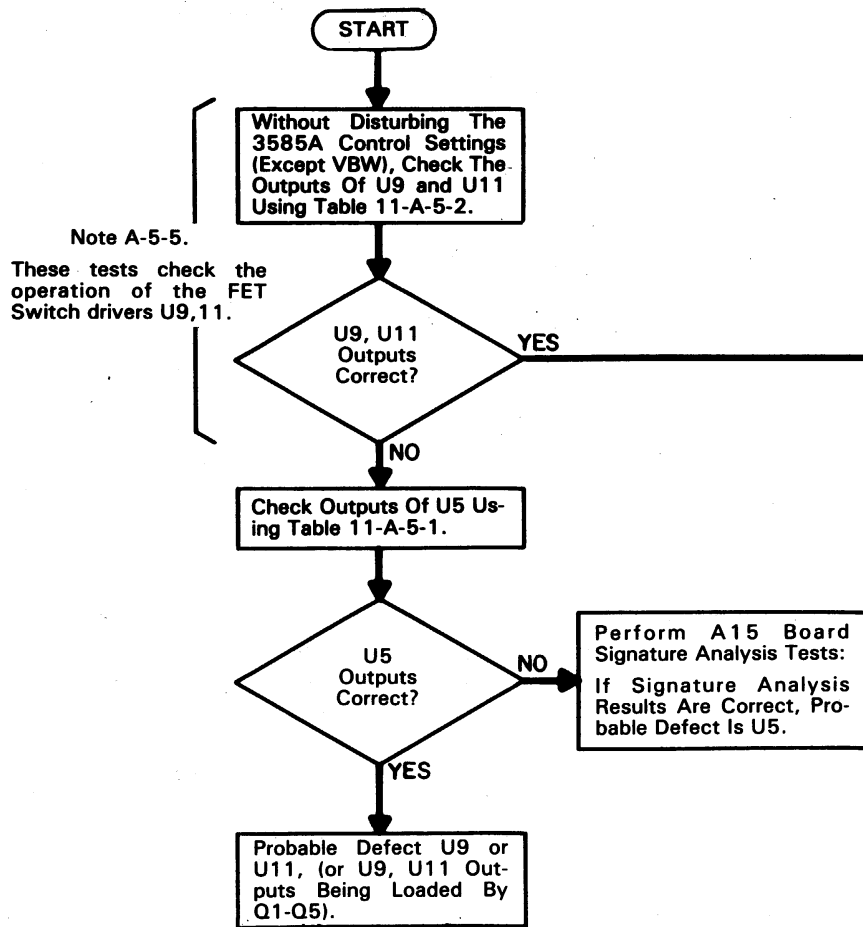
Table 11-A-5-2. U9, U11 Output Checks

VBW	U9Pin*			U11 Pin*	
	1	14	13	1	14
30kHz	L	L	H	L	L
10kHz	L	H	L	L	L
3kHz	H	L	L	L	L
1kHz	L	L	L	L	L
300Hz	L	H	L	L	H
100Hz	H	L	L	L	H
30Hz	L	L	L	L	H
10Hz	L	H	L	H	L
3Hz	H	L	L	H	L
1Hz	L	L	L	H	L

\*H = 0V to +1V;  
L = -15V (nominal)

Note A-5-6.  
These tests check the operation of Q2-4 and C5-7.





Note A-5-5.

These tests check the operation of the FET Switch drivers U9,11.

**Table 11-A-5-1. U5 Output Checks**

VBW	U5 Pin*				
	5	7	10	12	15
30kHz	H	H	L	H	H
10kHz	H	L	H	H	H
3kHz	L	H	H	H	H
1kHz	H	H	H	H	H
300Hz	H	L	H	H	L
100Hz	L	H	H	H	L
30Hz	H	H	H	H	L
10Hz	H	L	H	L	H
3Hz	L	H	H	L	H
1Hz	H	H	H	L	H

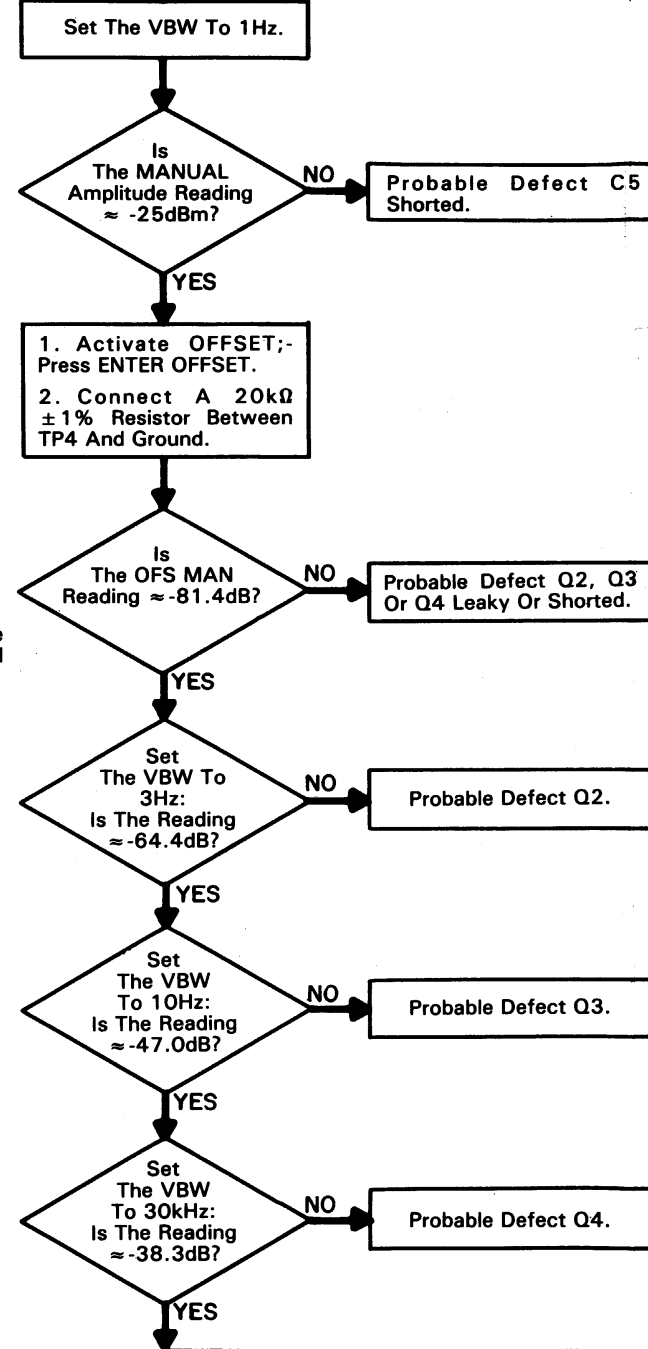
TTL: H = +3.5V to +5V;  
L = 0V to +0.6V

**Table 11-A-5-2. U9, U11 Output Checks**

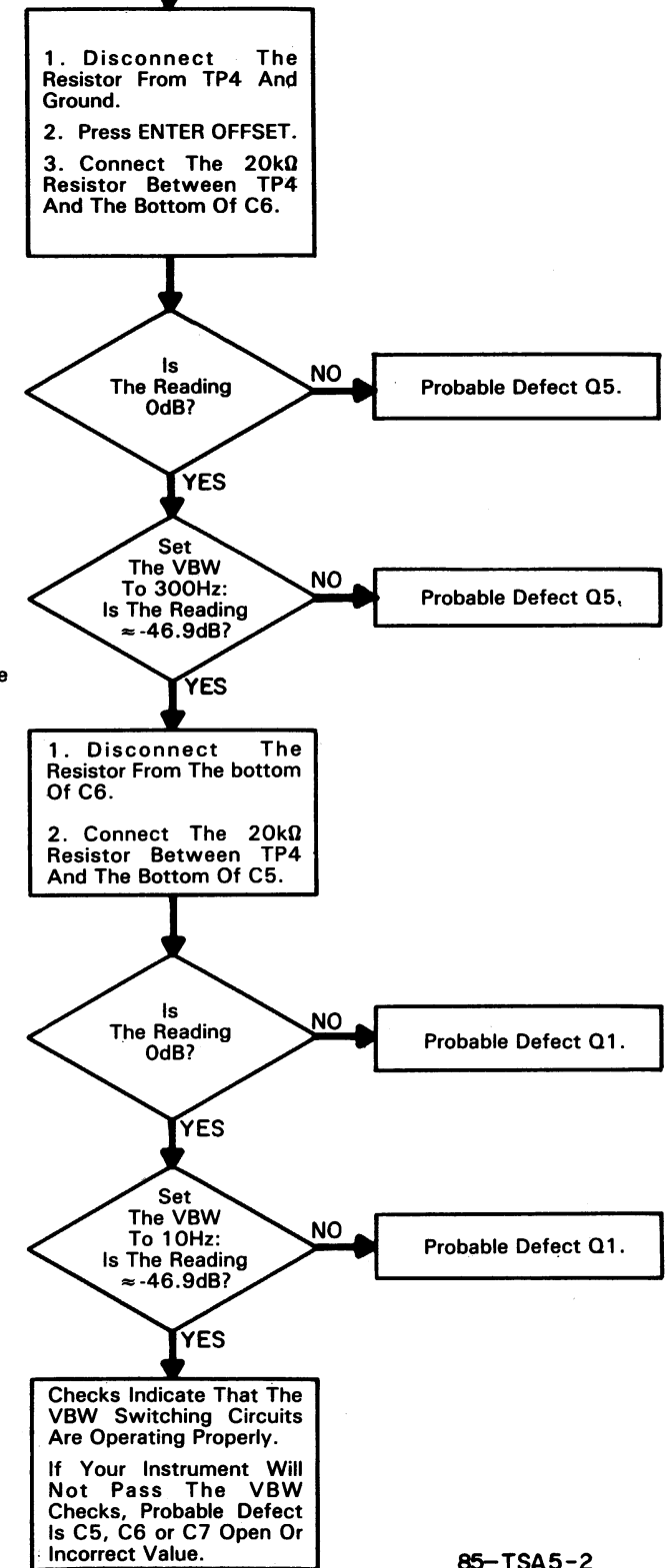
VBW	U9 Pin*			U11 Pin*	
	1	14	13	1	14
30kHz	L	L	H	L	L
10kHz	L	H	L	L	L
3kHz	H	L	L	L	L
1kHz	L	L	L	L	L
300Hz	L	H	L	L	H
100Hz	H	L	L	L	H
30Hz	L	L	L	L	H
10Hz	L	H	L	H	L
3Hz	H	L	L	H	L
1Hz	L	L	L	H	L

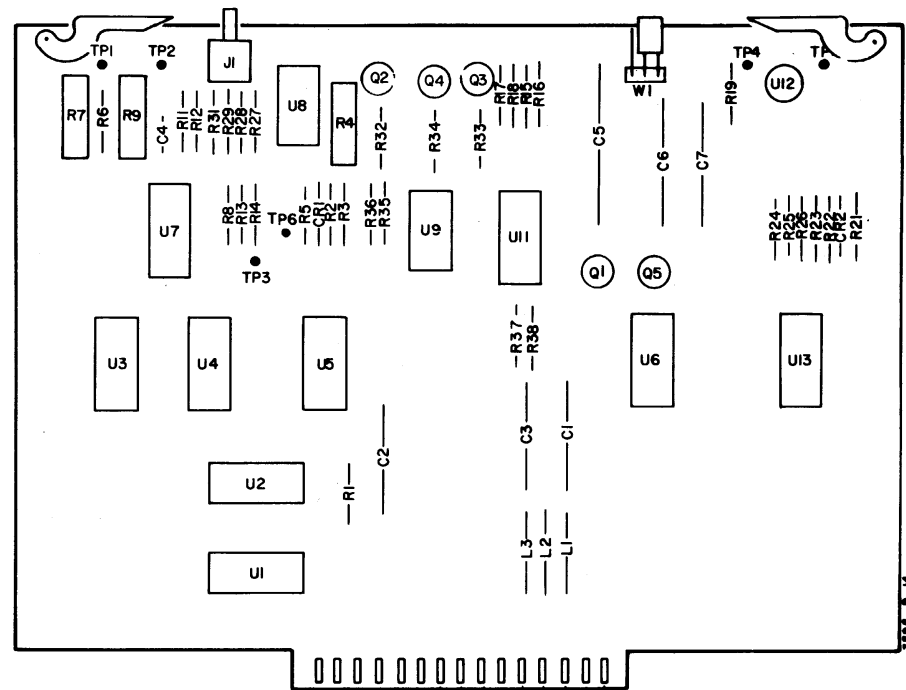
\*H = 0V to +1V;  
L = -15V (nominal)

Note A-5-6.  
These tests check the operation of Q2-4 and C5-7.

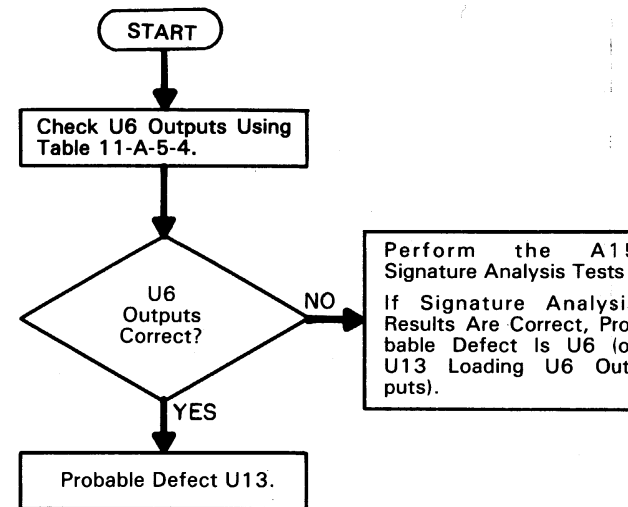


Note A-5-7.  
These tests check the operation of Q1 and Q5.





A15  
03585-66515

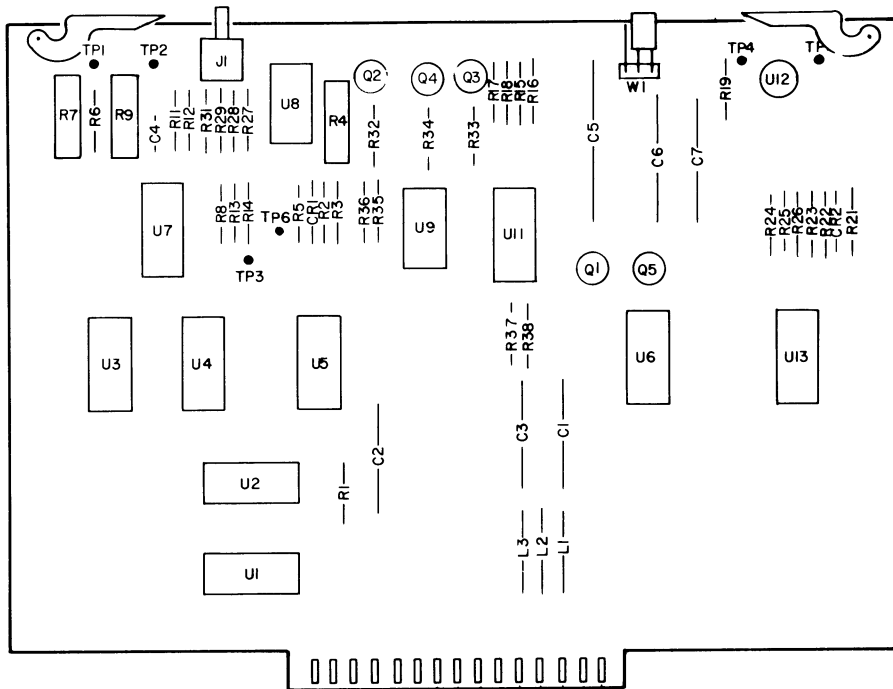


85-TSA5-3

Table 11-A-5-4. U6 Output Checks

dB/DIV	U6 Pin			
	15	12	7	10
10dB	L	H	H	H
5dB	H	L	H	H
2dB	H	H	L	H
1dB	H	H	H	L

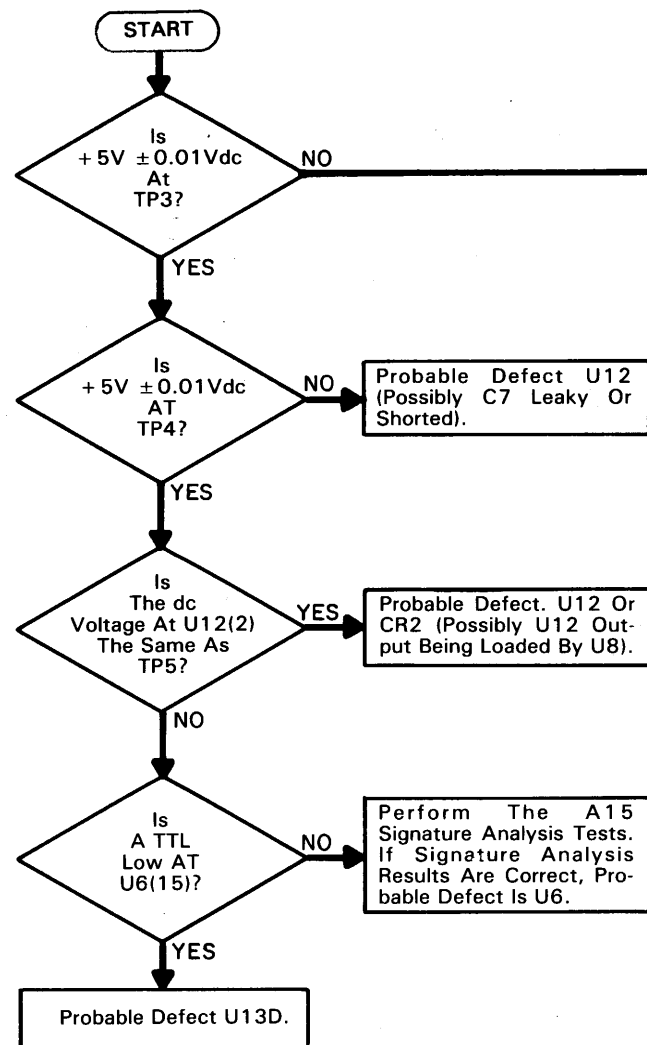
H = +3.5V +5V;  
L = 0V to +0.6V.



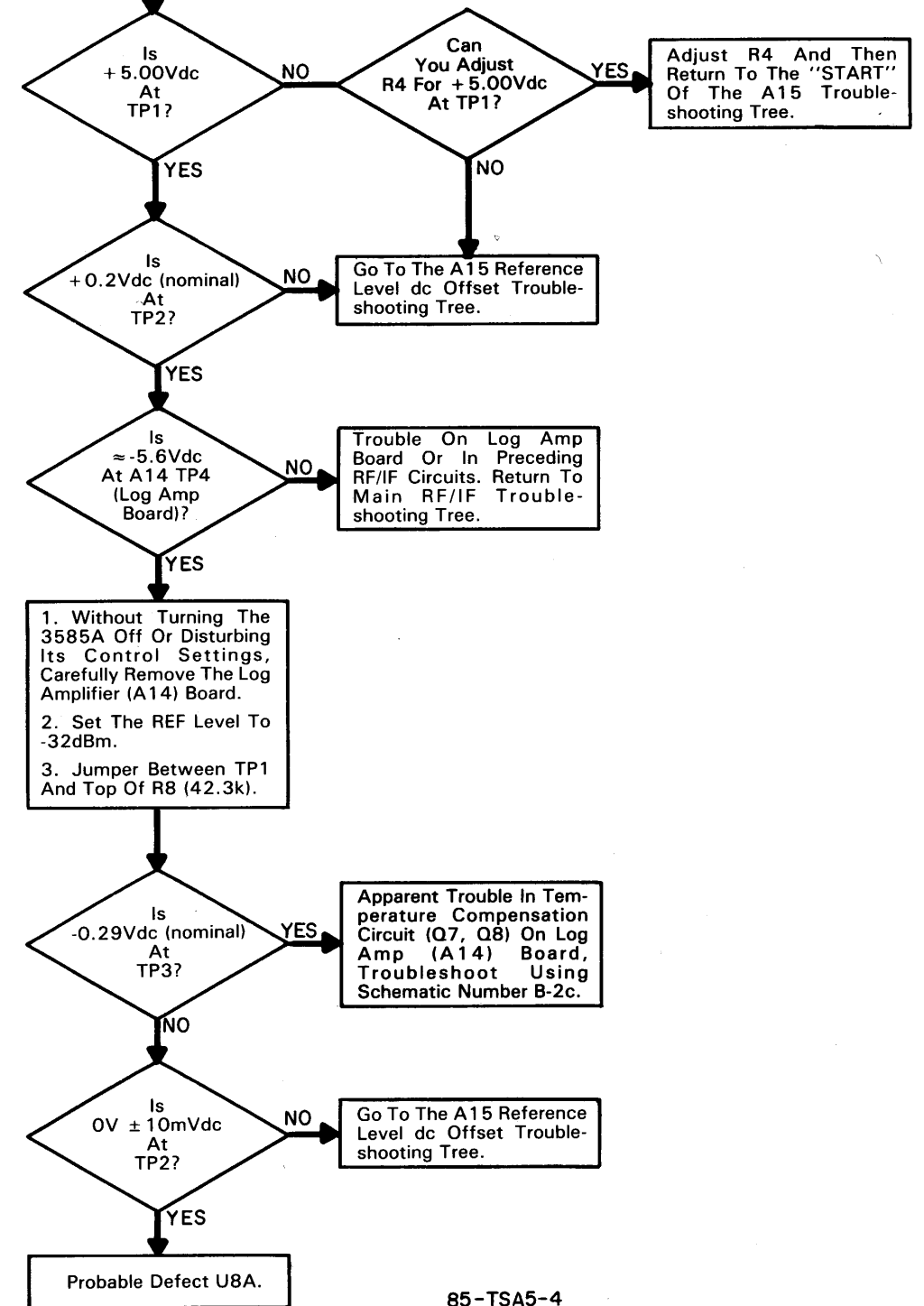
A15  
03585-66515

Note A-5-2.  
This test separates the DC offset circuit from the VBW and dB/DIV circuits.

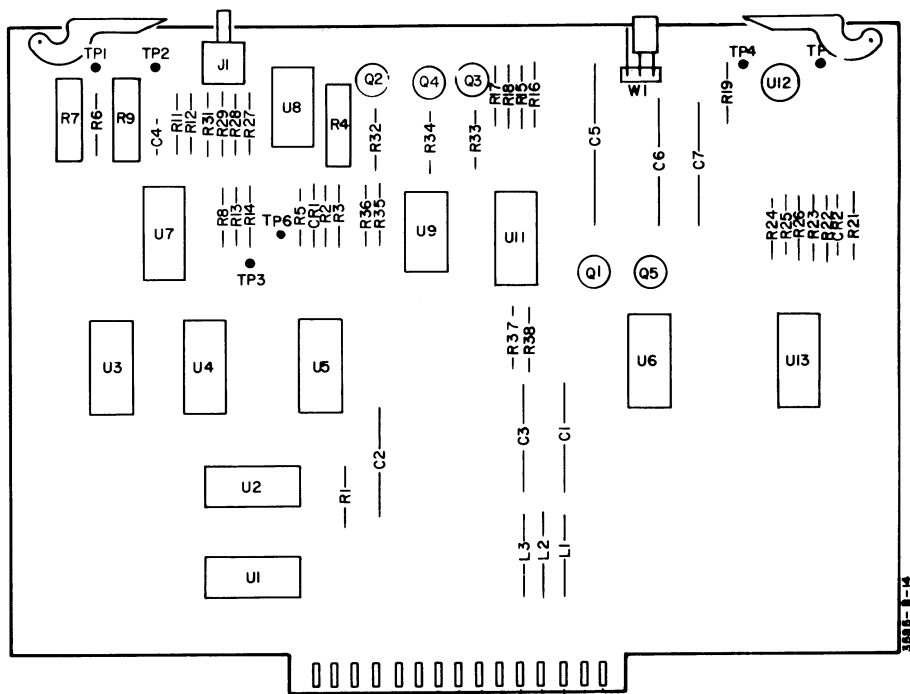
This test checks the FET switches in the dB/DIV feedback loop.



Note A-5-3.  
This group of tests helps isolate the problem to the 5V Reference, the DC Offset circuit, the Summing amp(U8) or the output of the A14 board. This process is somewhat difficult because the signal is current which is sourced by the summing junction of U8 and sunk by A14.



85-TSA5-4



A15  
03585-66515

3008-B-14



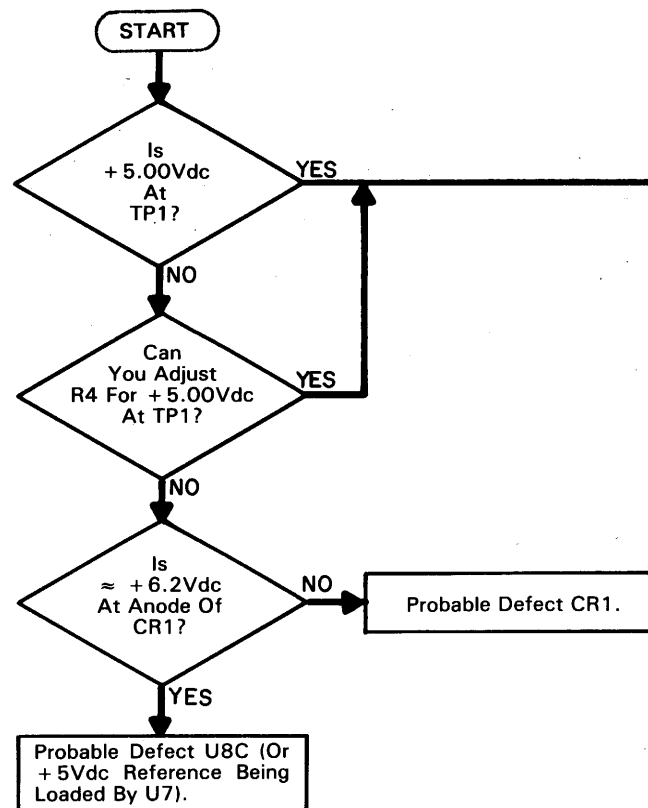
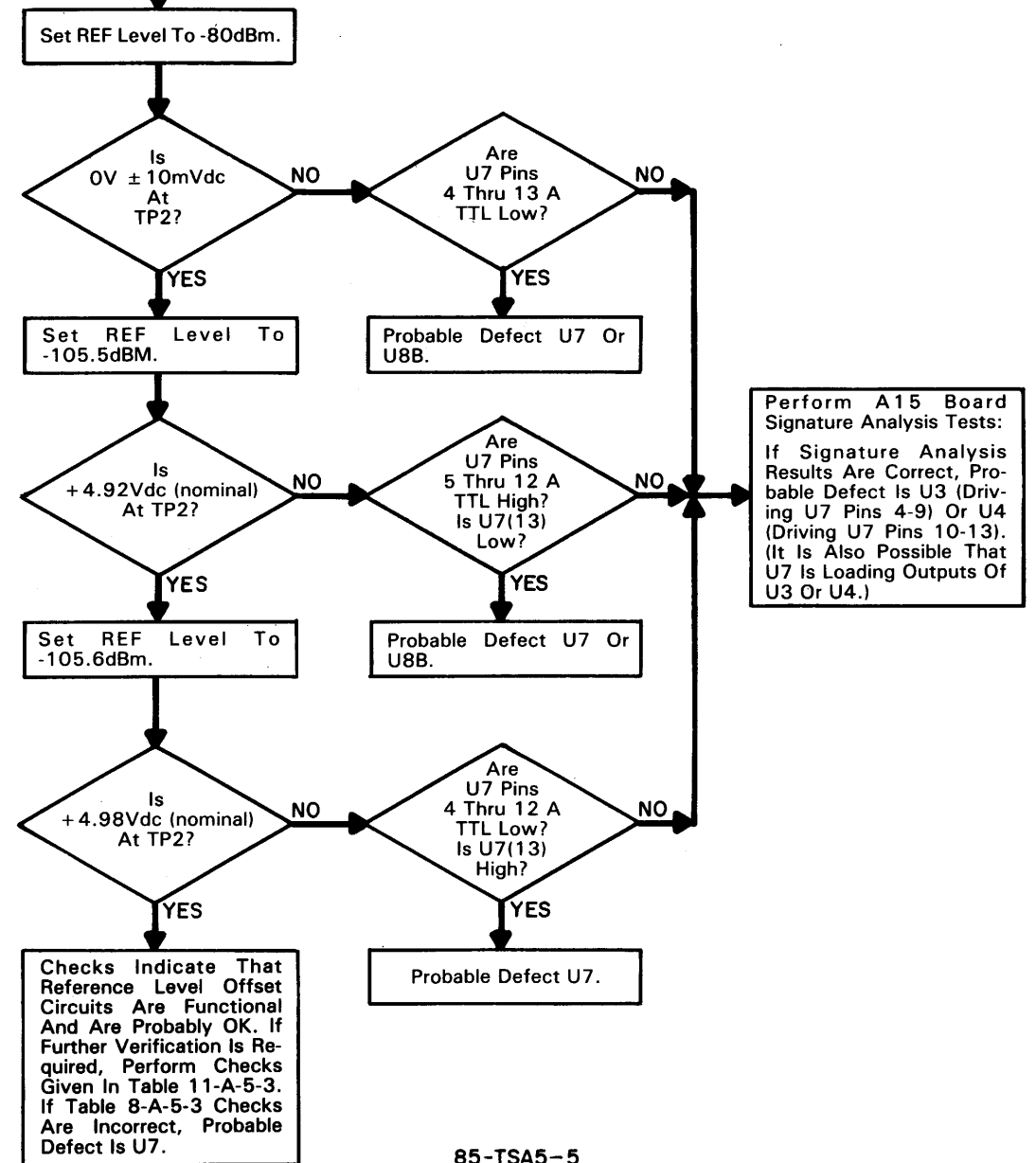


Table 11-A-5-3. Reference Level D/A Checks\*

Reference Level (dBm)	TP2 Voltage
- 80.0	0.0V to +0.003V
- 80.1	+0.014V to +0.024V
- 80.2	+0.033V to +0.043V
- 80.4	+0.070V to +0.080V
- 80.8	+0.150V to +0.160V
- 81.6	+0.305V to +0.315V
- 83.2	+0.615V to +0.625V
- 86.4	+1.230V to +1.250V
- 92.8	+2.470V to +2.500V
-105.6	+4.960V to +4.990V

\*These checks must be performed in Instrument Test Mode O3 and with the reference voltage at A15 TP1 set to +5V ± 1mVdc.

Note A-5-4.  
This procedure checks all the input lines of the DAC (U7). U7(5-12) are TTL high and U7(13) TTL low at -105.5dBm. At -105.6dBm the situation is reversed with U7(5-12) low and U7(13) high.



85-TSA5-5

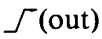
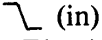
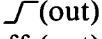
**A15 Board Signature Analysis Tests.**

Equipment Required: Signature Analyzer (-hp- Model 5004A).

- a. Turn the instrument off.
- b. On the A45 board (tabs = Yellow/Green), set DIP test switches 2, 3 and 6 to the “on” (inboard) position. Verify that all other A45 test switches are in the “OPEN” (outboard) position.
- c. Connect the Signature Analyzer as follows:

START and STOP-----A45 TP1  
 CLOCK-----A45 TP2  
 GND-----A45 “GND” Test Point

- d. Set the Signature Analyzer controls as follows:

START-----  (out)  
 STOP-----  (in)  
 CLOCK-----  (out)  
 HOLD-----off (out)  
 SELF TEST-----off (out)

- e. Turn the 3585A (and Signature Analyzer) on.
- f. At this point, the CRT screen should be blank, the front-panel LED indicators should be flashing and the red LED on the A45 board should be flashing.
- f. To verify that your test setup is correct and the test routine is running properly, touch the Signature Analyzer test probe to A15 pin A13 (+ 5Vdc). The signature should be “C2HH”.
- g. Check for the following signatures at A15 pins A3 thru A10:

A15 Pin	Signature
A3	68U1
A4	873H
A5	A14U
A6	U429
A7	4P86
A8	1430
A9	0593
A10	PF5F

- 1. If signatures are correct, go to Step h.
- 2. If signatures are incorrect, trouble is on I/O board (A45, Service Group C-3), or lines are being loaded by A15 board of A17-A19 IF boards.

h. check for the following signatures at U2 pins 12 thru 15:

U2 Pin	Signature
12	2FH5
13	7AAU
14	73AF
15	1A87

1. If signatures are correct, no further Signature Analysis Tests are required. Disconnect the Signature Analyzer, set the A45 test switches to the "OPEN" position and correct the defect indicated on the A15 Troubleshooting Tree.
2. If signatures are correct, go to step i.

i. Check for the following signatures at U2 pins 1 thru 4:

U2 Pin	Signature
1	027F
2	0100
3	446C
4	8866

1. If signatures are correct, Probable Defect is U2.
2. If signatures are incorrect, Probable Defect is U1 (or U1 outputs being loaded by U2).

# SERVICE GROUP A-6 ANALOG-TO-DIGITAL CONVERTER

**Board No. A16  
Part Number 03585-66516**

**INDEX:**

Title	Page No.
Analog-To-Digital Converter (A16) Troubleshooting Tree .....	11-137/11-138
A16 Main Signal Path Troubleshooting Tree .....	11-139/11-140
A16 Sample and Hold Troubleshooting Tree .....	11-141/11-142
A16 Peak Detector Troubleshooting Tree .....	11-143/11-144
A16 Amplitude Offset Troubleshooting Tree .....	11-145/11-146
A16 Power Supply Troubleshooting Tree .....	11-147/11-148

**ADJUSTMENTS:**

Component	Adjusted Parameter	Paragraph Location
A16R21	Reference Voltage for A/D Converter	5-16
A16R19	Full Scale Marker Amplitude	5-16

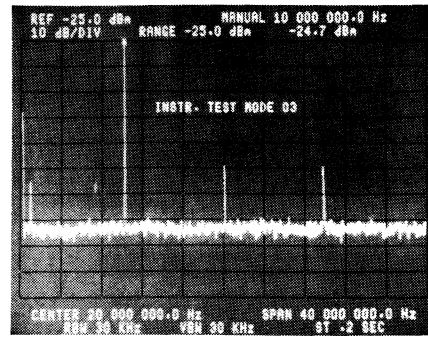


Figure 11-A-6-1. Normal Display - Test Mode 03 Integrated

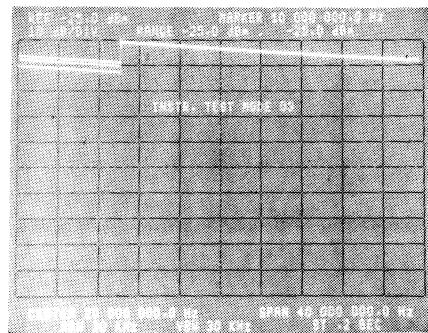
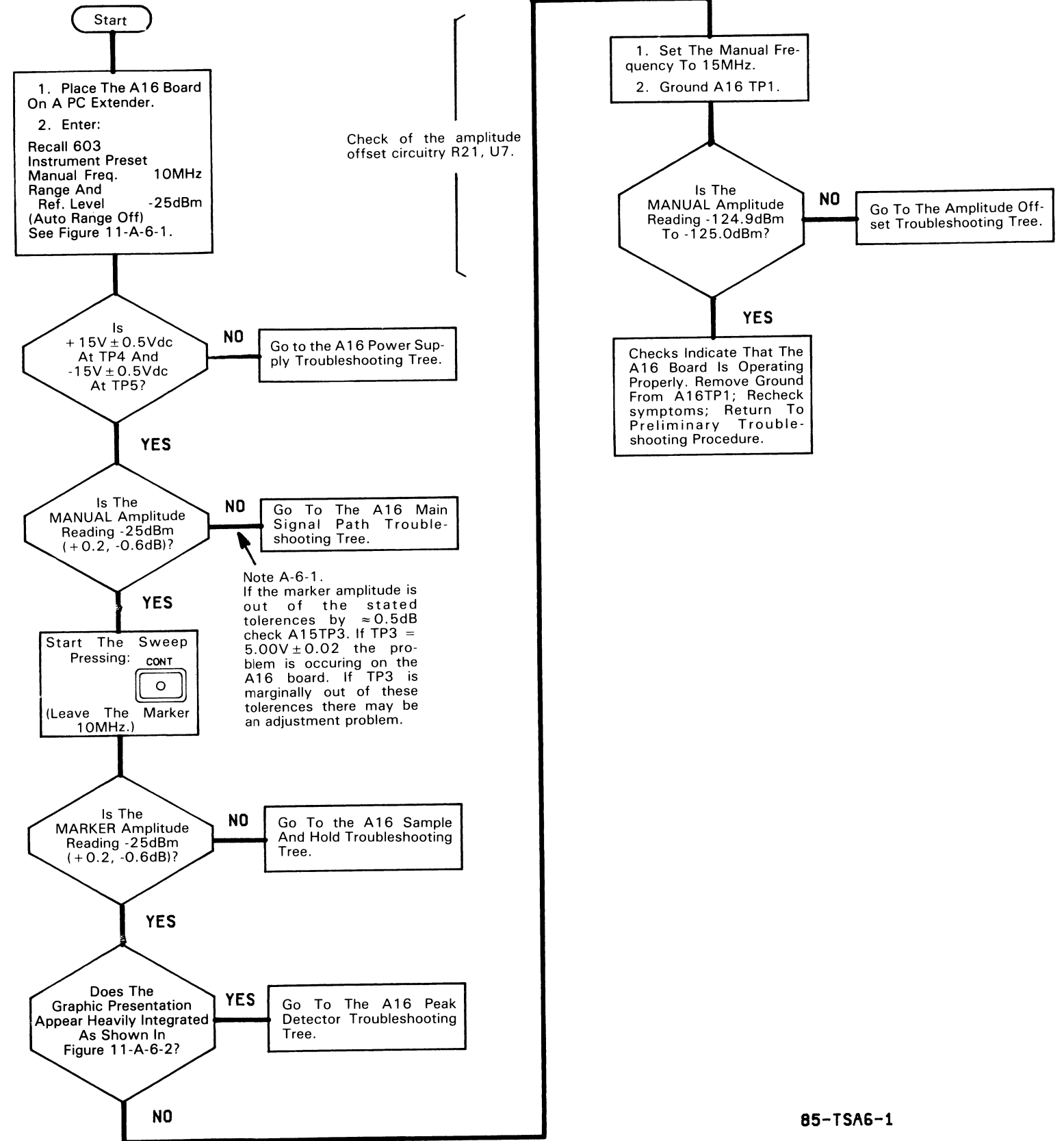
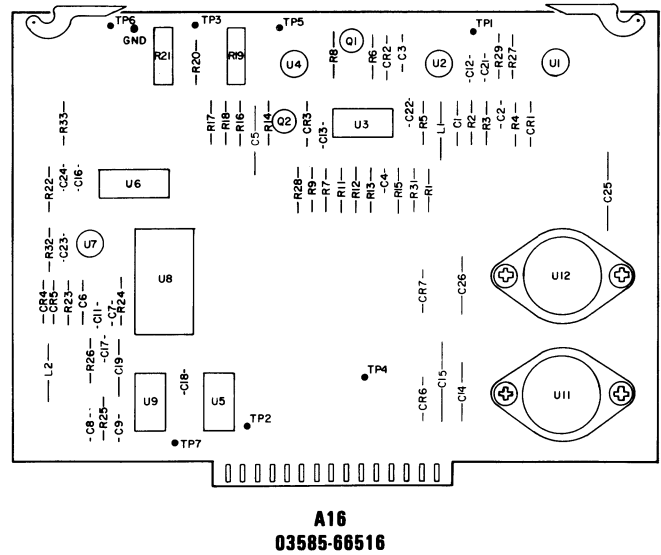
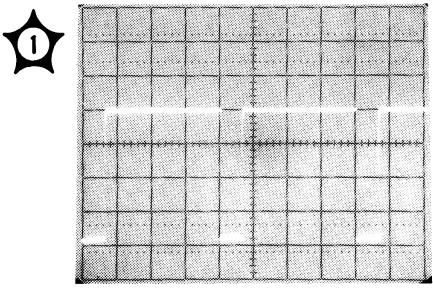
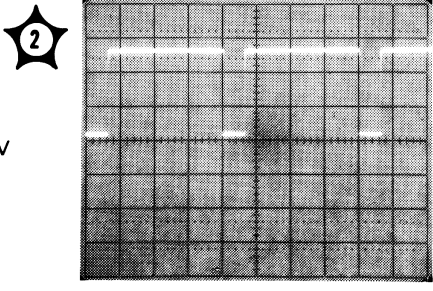


Figure 11-A-6-2. Integrated, Moderately Integrated And Heavily Integrated Display

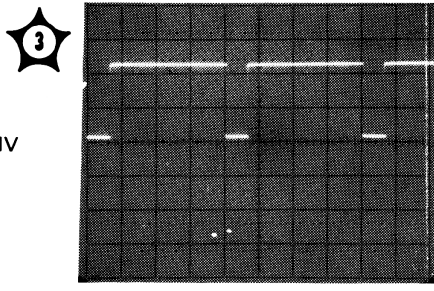




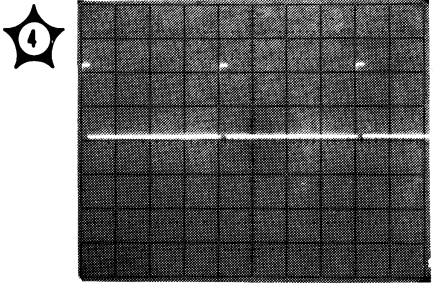
50μsec/DIV



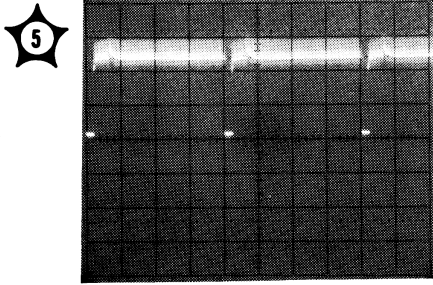
50μsec/DIV



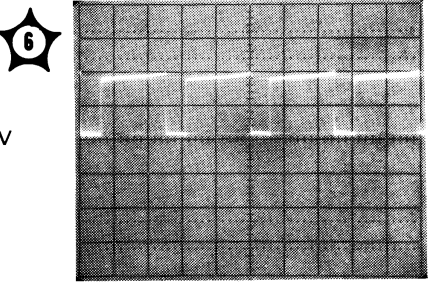
50μsec/DIV



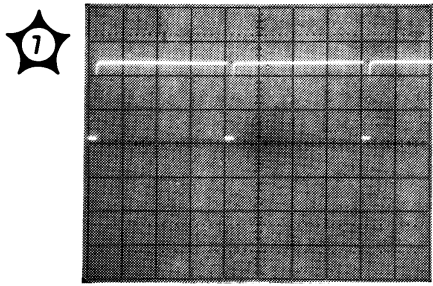
50μsec/DIV



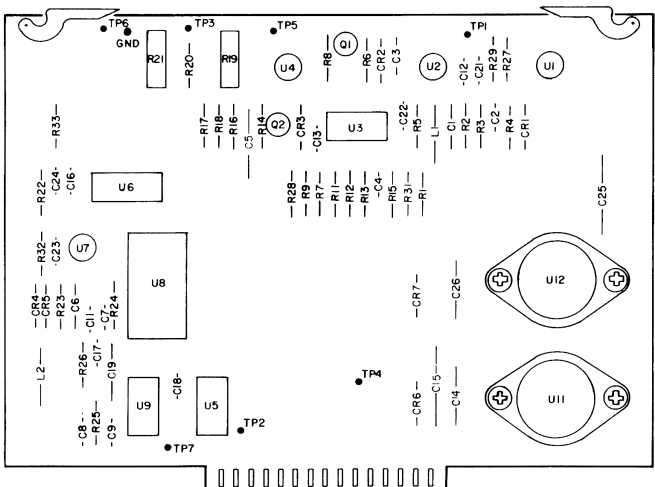
50μsec/DIV



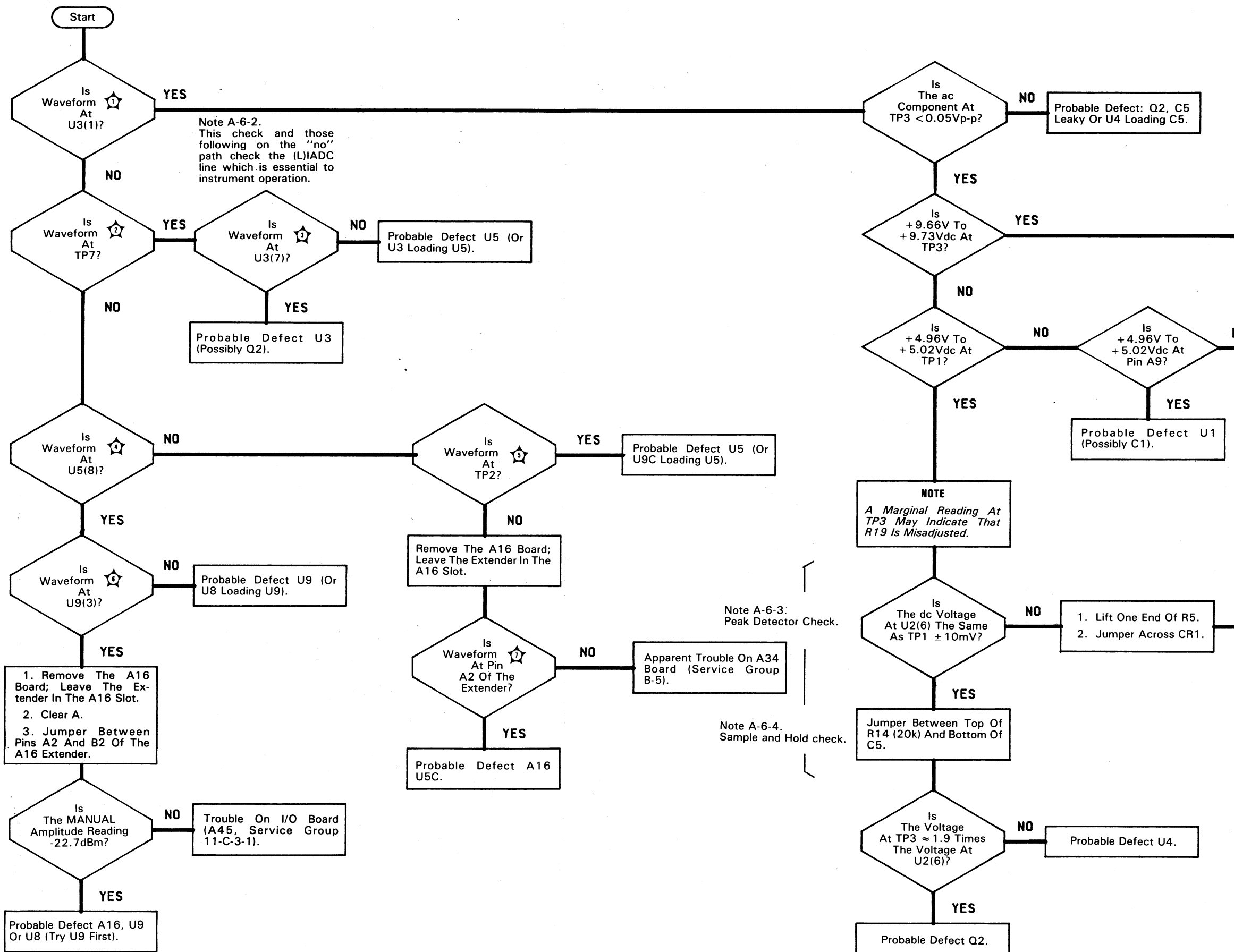
1μsec/DIV



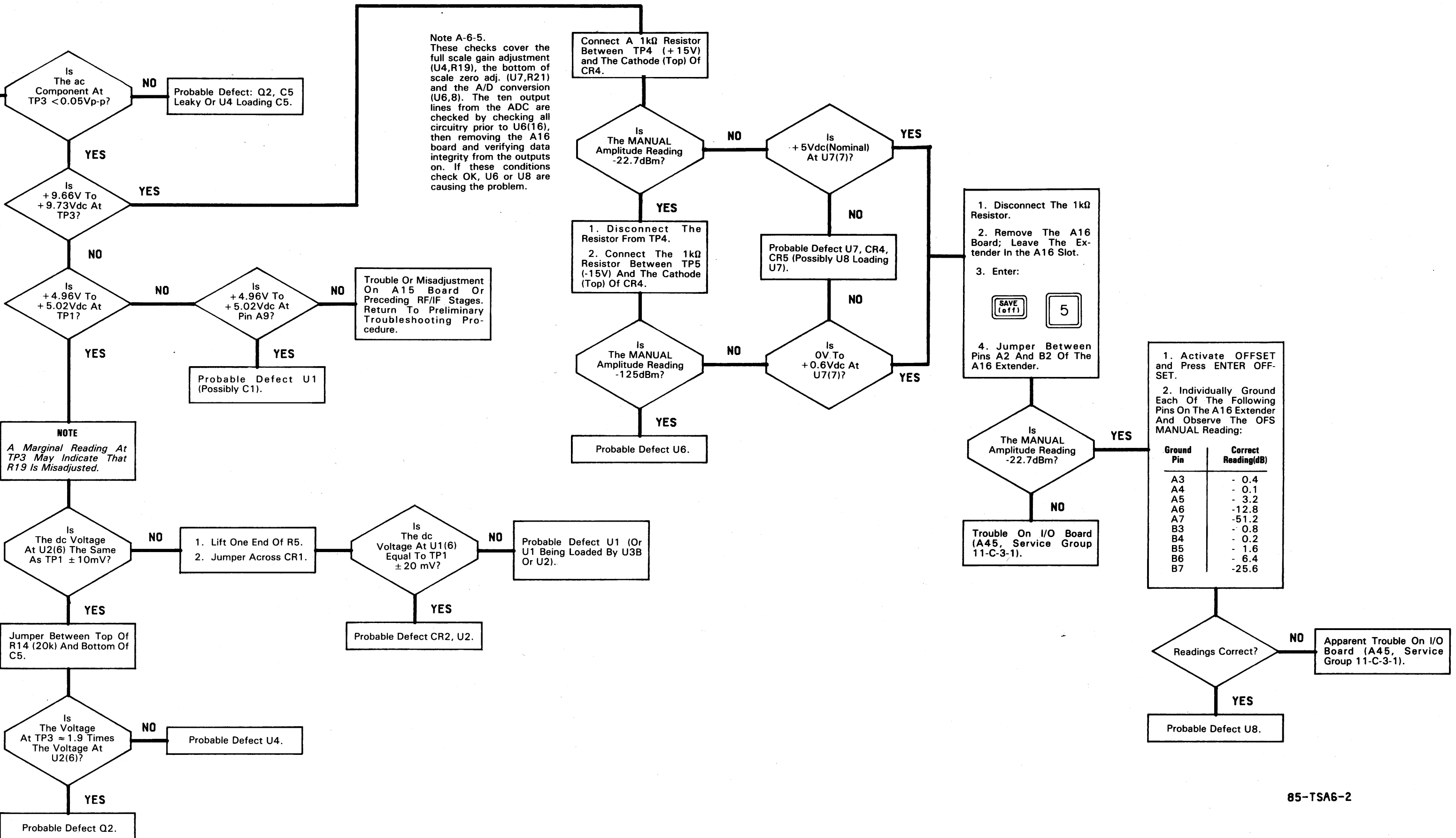
50μsec/DIV



A16  
03585-66516



Note A-6-5.  
These checks cover the full scale gain adjustment (U4,R19), the bottom of scale zero adj. (U7,R21) and the A/D conversion (U6,8). The ten output lines from the ADC are checked by checking all circuitry prior to U6(16), then removing the A16 board and verifying data integrity from the outputs on. If these conditions check OK, U6 or U8 are causing the problem.



Ground Pin	Correct Reading(dB)
A3	- 0.4
A4	- 0.1
A5	- 3.2
A6	-12.8
A7	-51.2
B3	- 0.8
B4	- 0.2
B5	- 1.6
B6	- 6.4
B7	-25.6



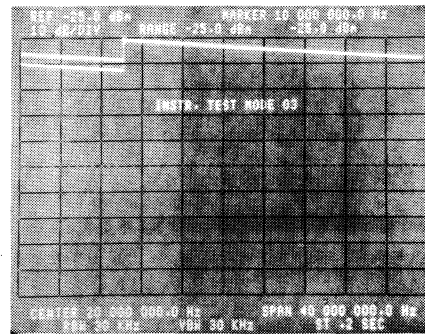
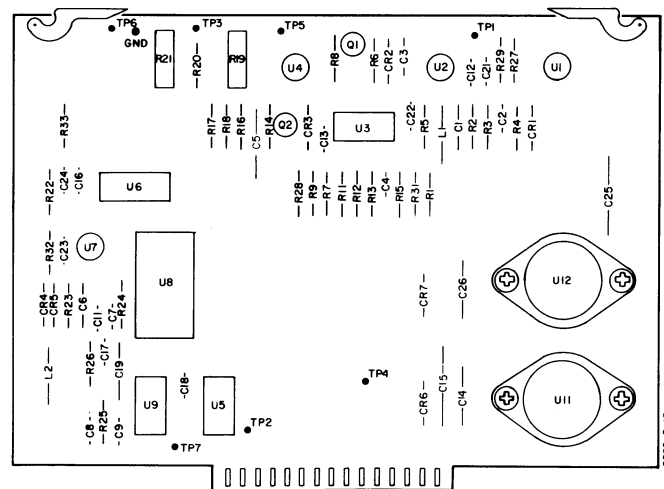
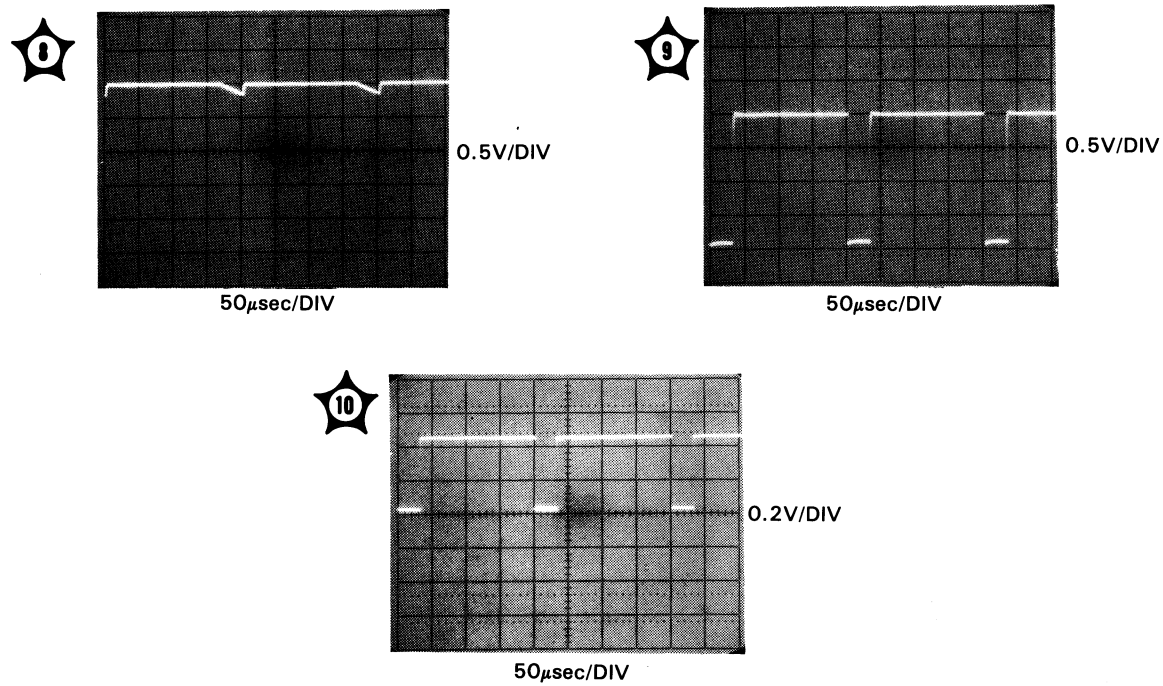
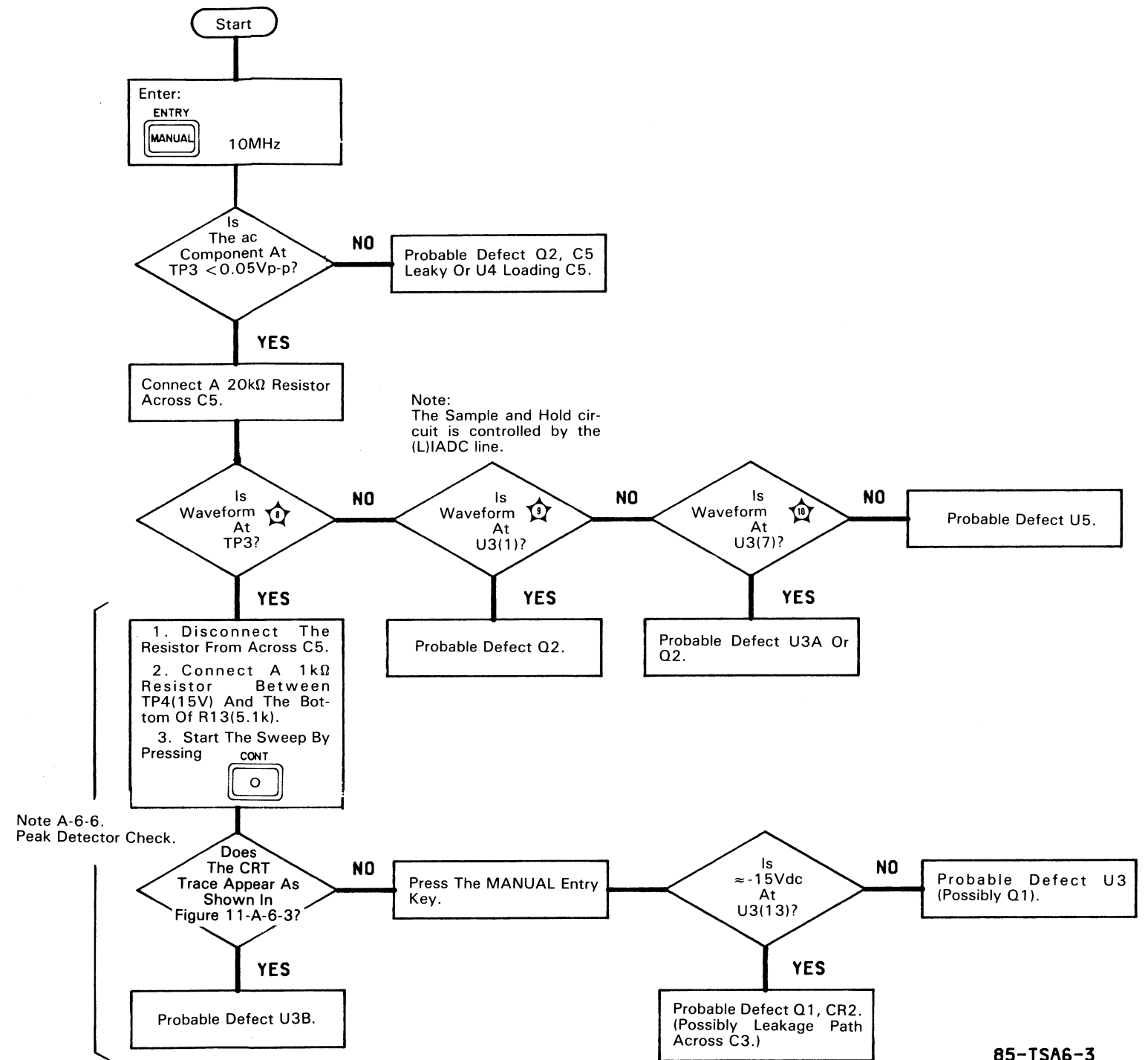


Figure 11-A-6-3. Heavily Integrated Display



A16  
03585-66516



Note A-6-6.  
Peak Detector Check.

85-TSA6-3

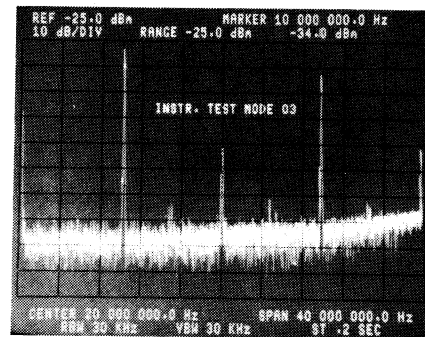
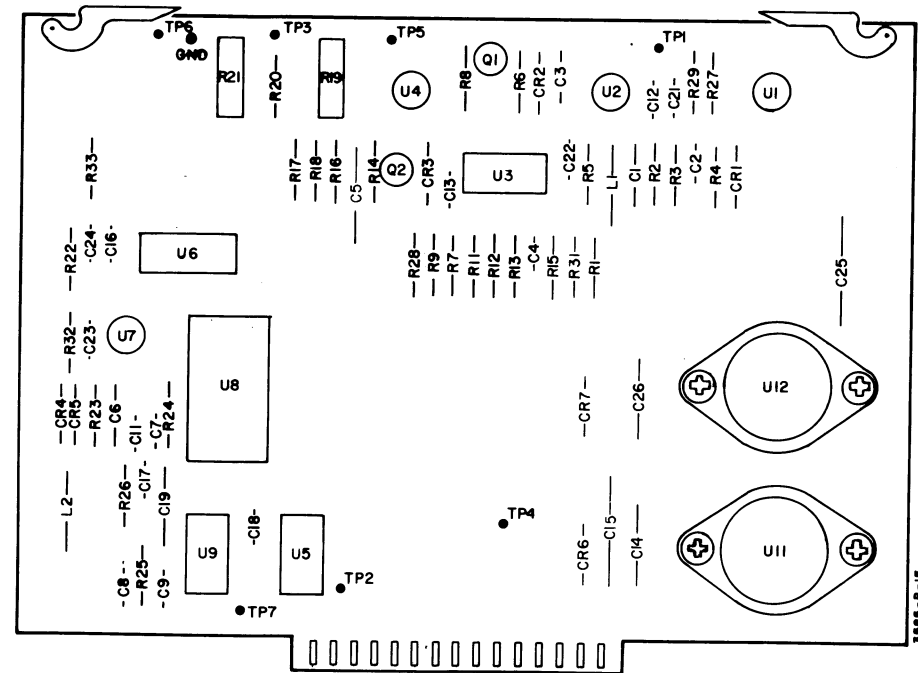
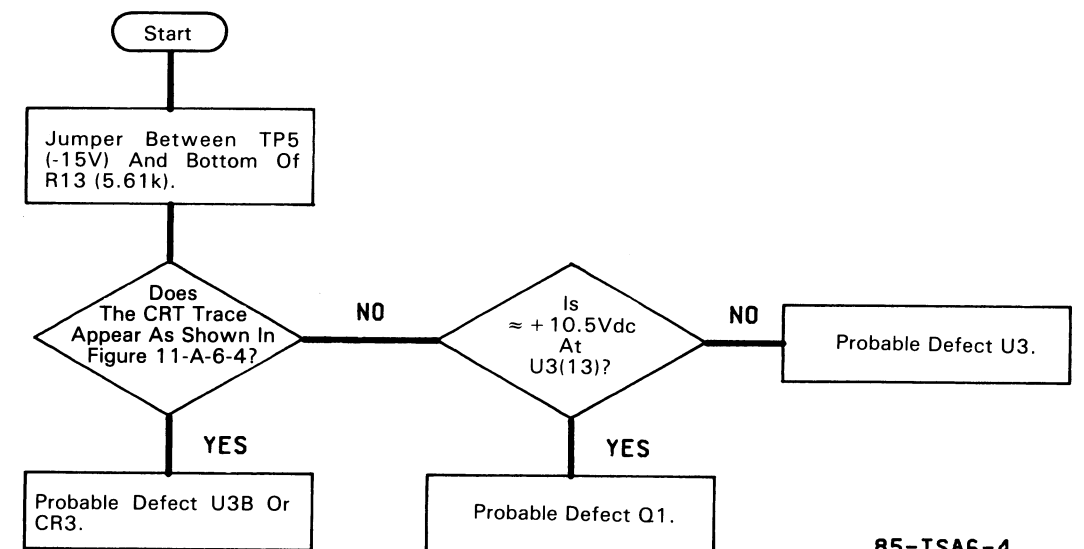
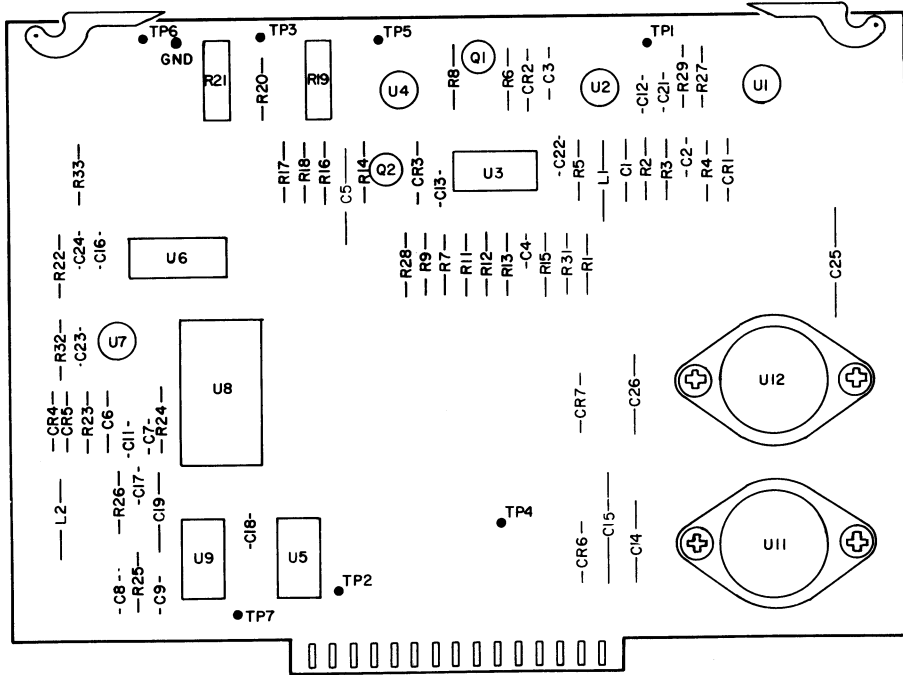


Figure 11-A-6-4. Display With Peak Detector Disabled

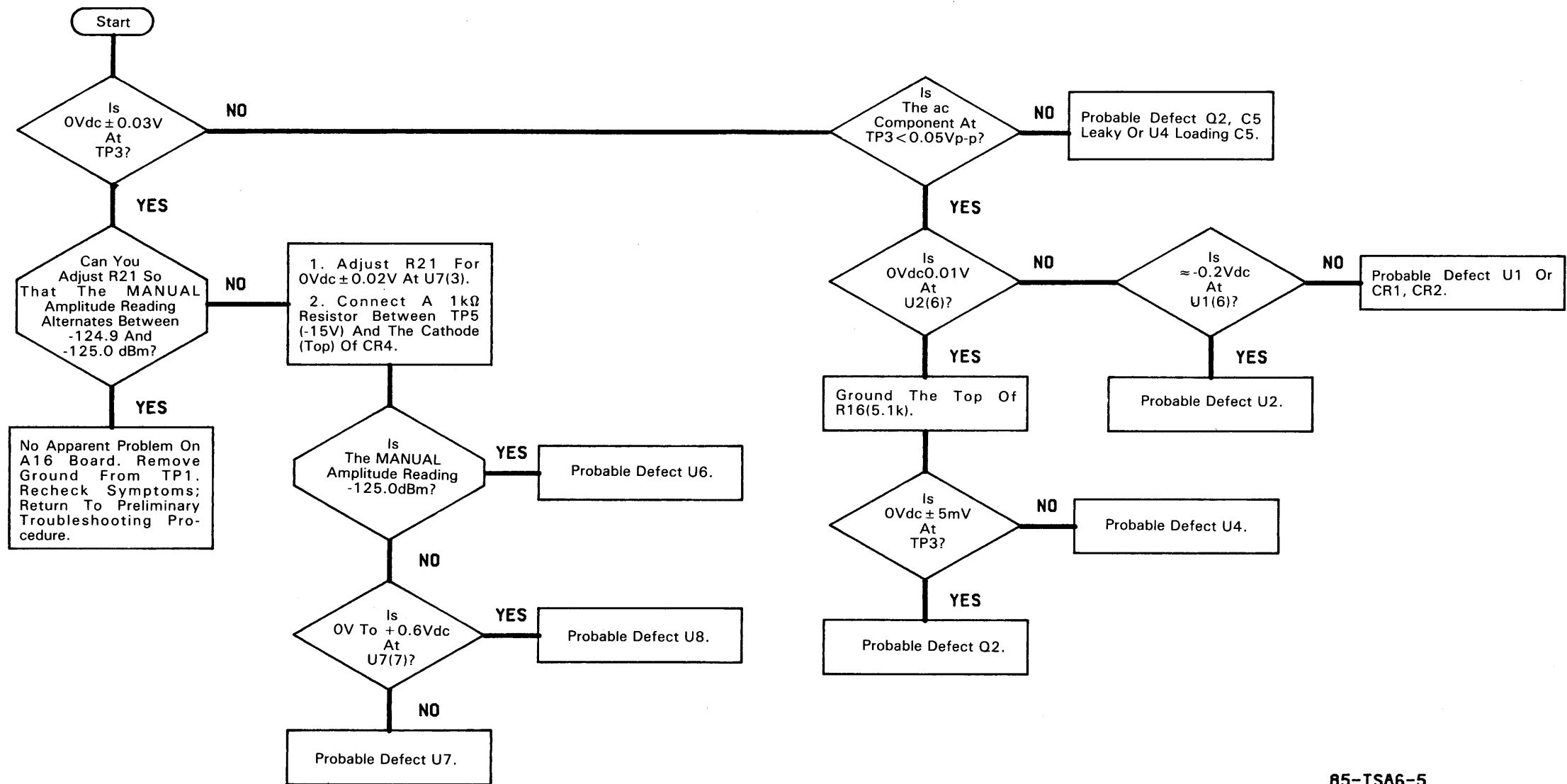


85-TSA6-4

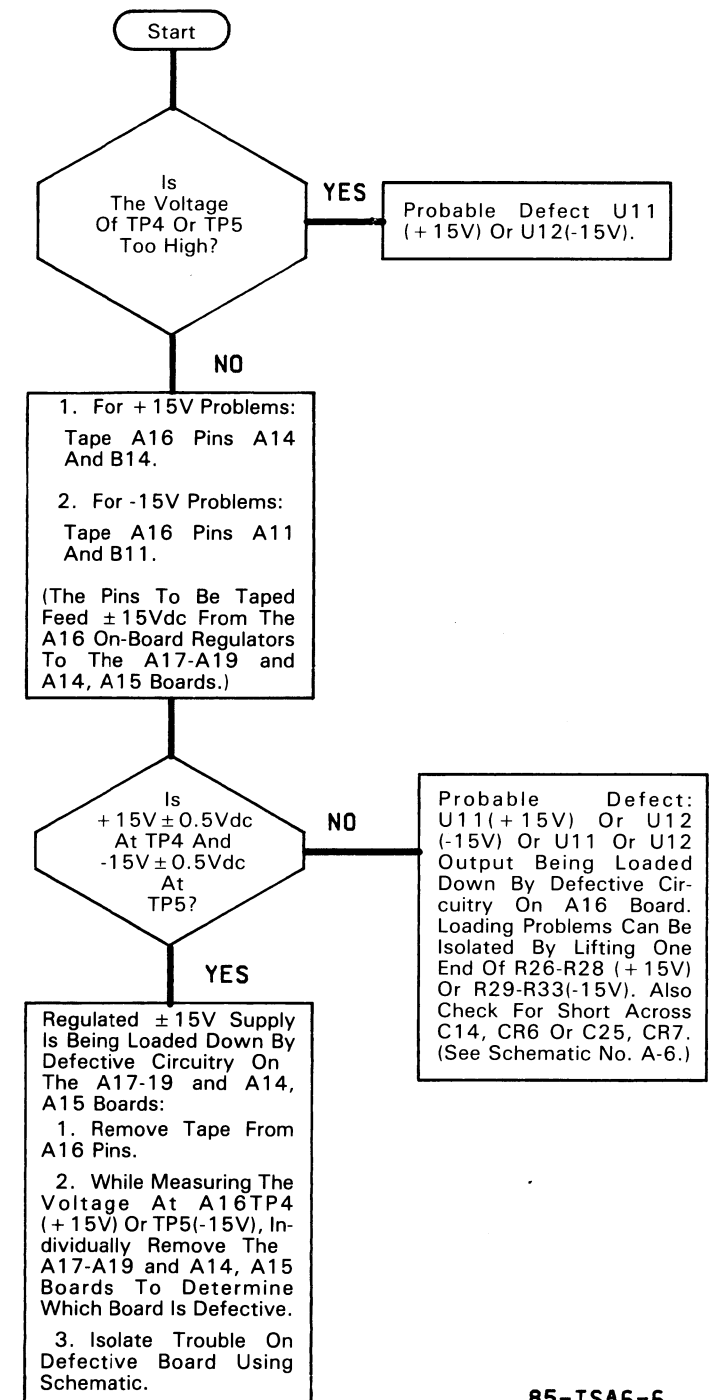
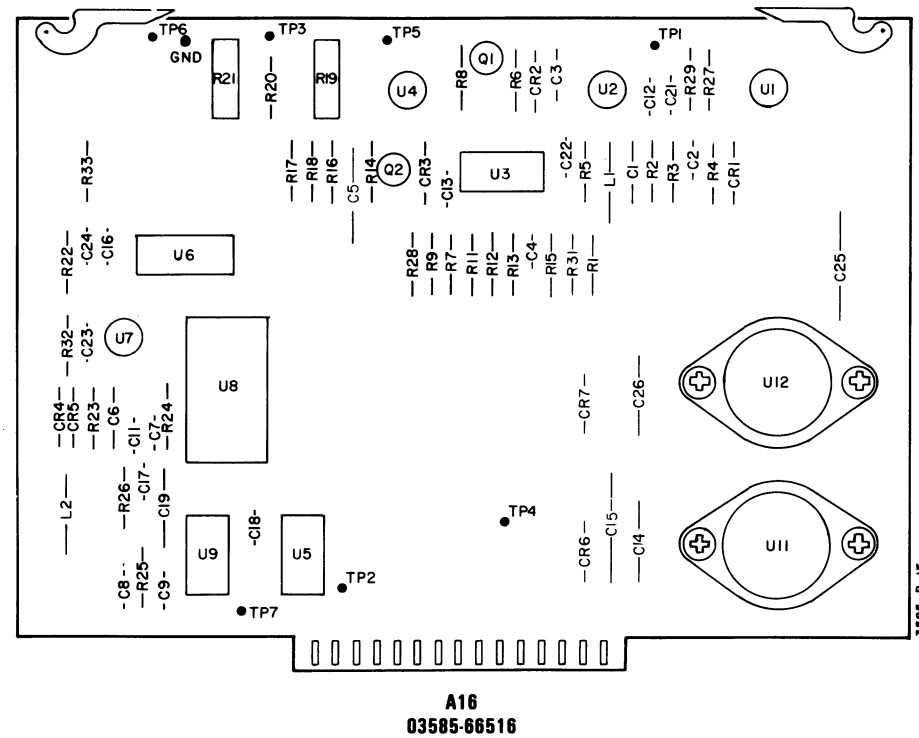


3505-R-15

**A16**  
**03585-66516**



85-TSA6-5



85-TSA6-6

# SERVICE GROUP B LOCAL OSCILLATOR

**Board Number's A21-34**

**INDEX:**

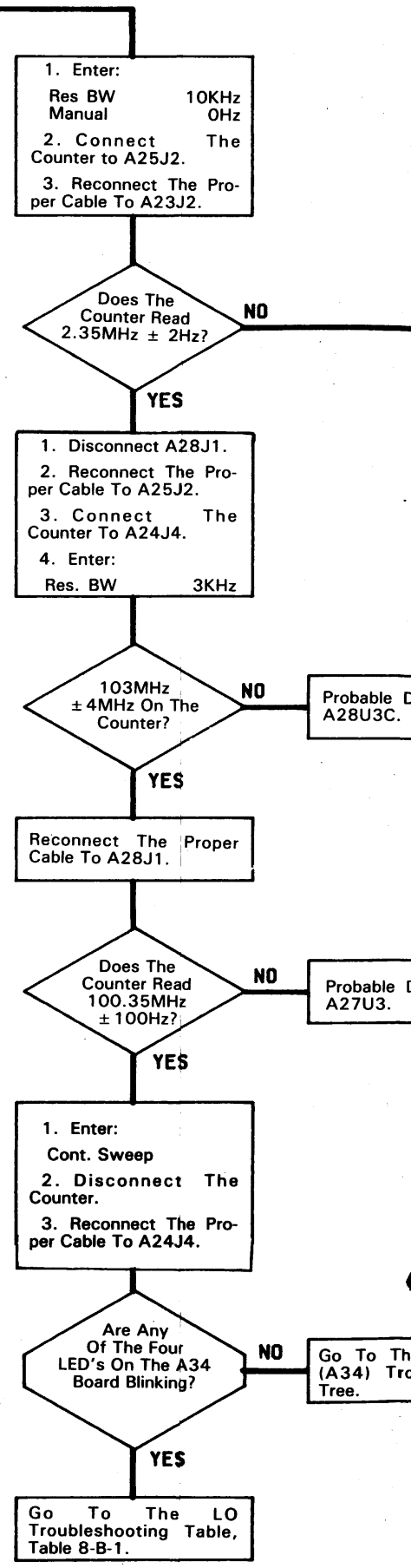
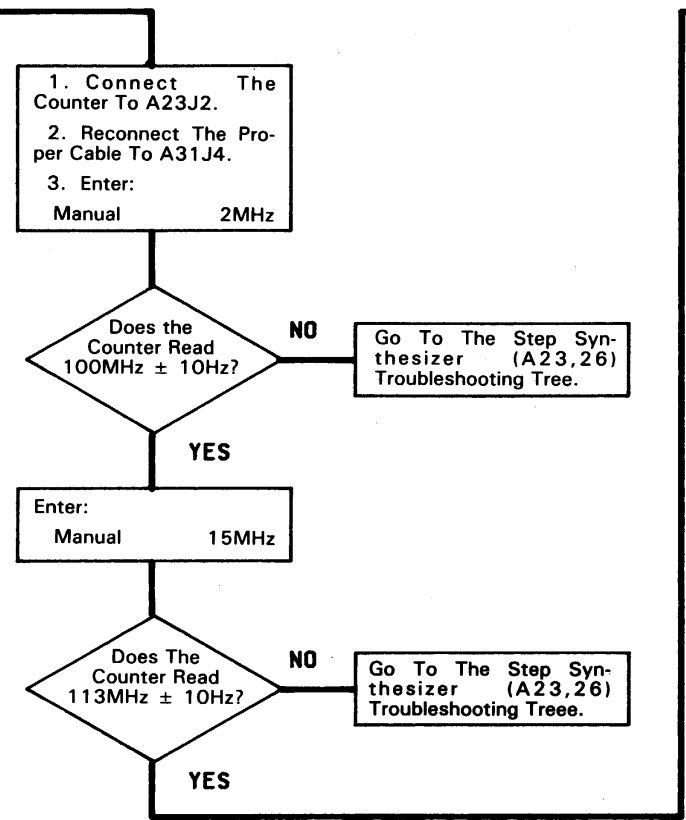
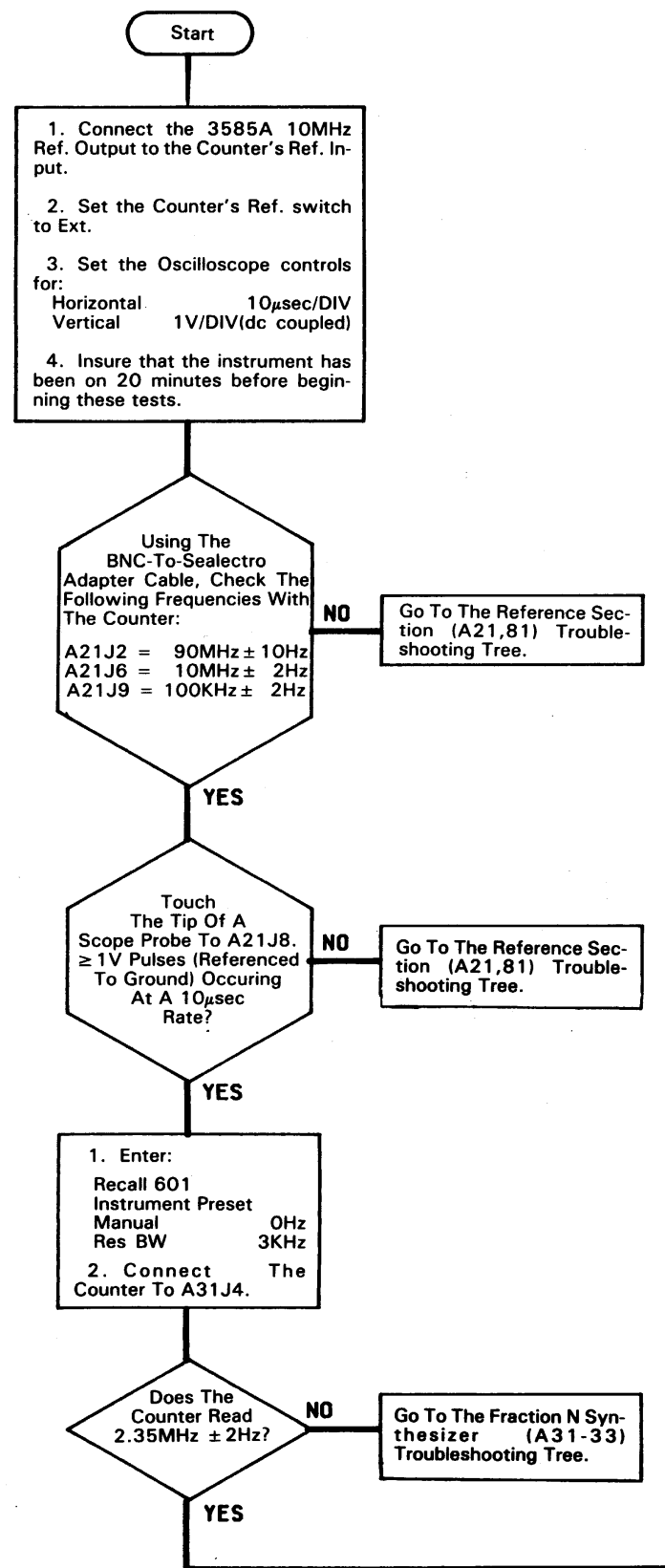
Title	Service Group No.	Page No.
Main Local Oscillator Troubleshooting Tree.....	B	11-151/11-152
LO Troubleshooting Table.....	B	11-149/11-150
Reference Section (A21,81) Troubleshooting.....	B-1	11-153/11-154
Sum Loop (A22,24,25,27,28) Troubleshooting.....	B-2	11-161/11-162
Step Synthesizer (A23,26) Troubleshooting.....	B-3	11-173/11-174
Fractional N Synthesizer (A31-33) Troubleshooting.....	B-4	11-183/11-184
LO Control (A34) Troubleshooting.....	B-5	11-209

**EQUIPMENT REQUIRED:**

Instrument	Required Characteristics	Recommended Model No.
Digital Voltmeter	4½ digits, dc Accuracy ±0.05% ± 3 digits	-hp- Model 3466A
Ocilloscope (100MHz)	Bandwidth dc to 100MHz Sensitivity 0.05V/Div	-hp- Model 1740A
DC Power Supply	Regulated, Variable ±5V voltage/current monitor	-hp- Model 6216A
Frequency Synthesizer	Range 200Hz to 80MHz, Amplitude Accuracy ±0.2dB(50Ω)	-hp- Model 3335A
Digital Signature Analyzer	N.A.	-hp- Model 5004A
Divider Probe	1:1, ≤40pf	-hp- Model 10007B
Divider Probe	10:1, 1MΩ, ≤12pf	-hp- Model 10041A
Frequency Counter	Range 1kHz to 150MHz, External Ref. Input	-hp- Model 5382A

**Table 11-B-1. LO Troubleshooting Table.**

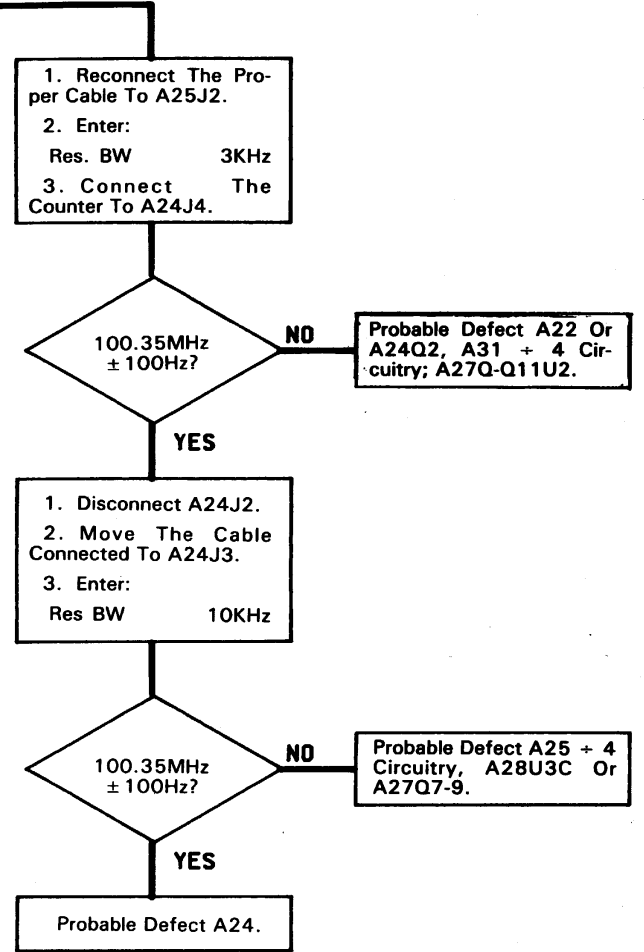
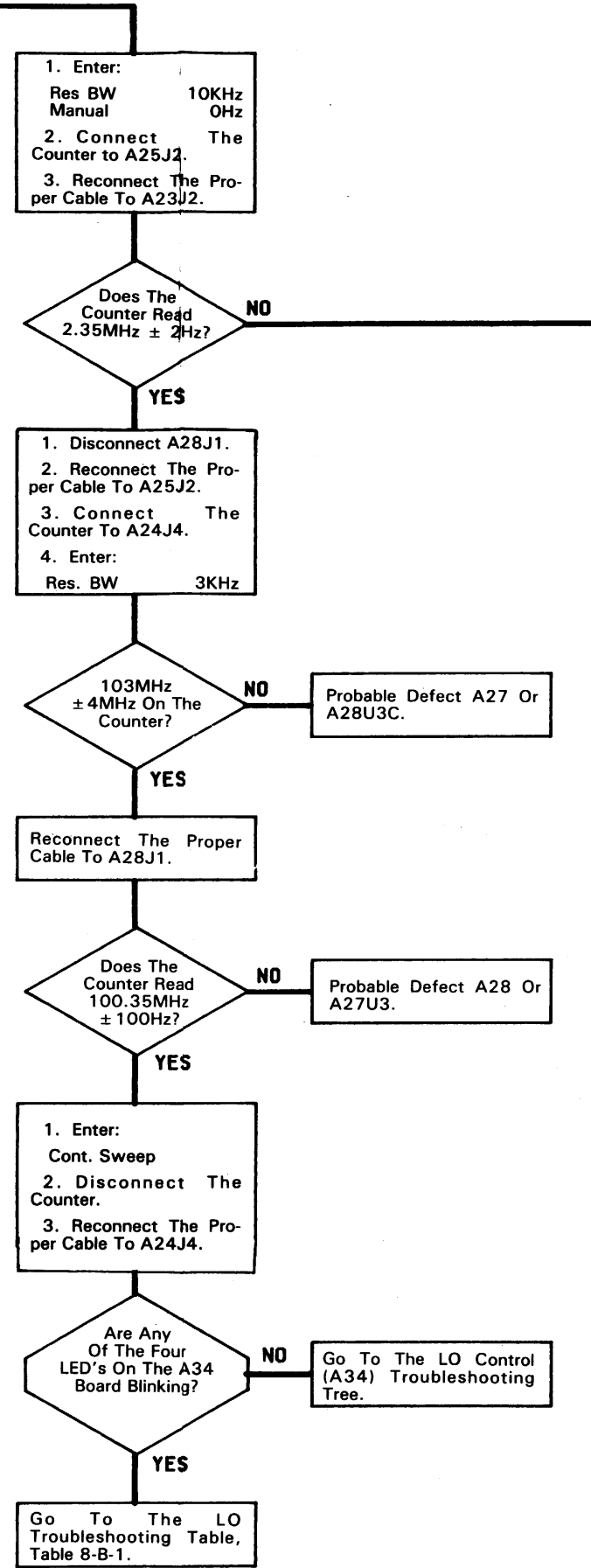
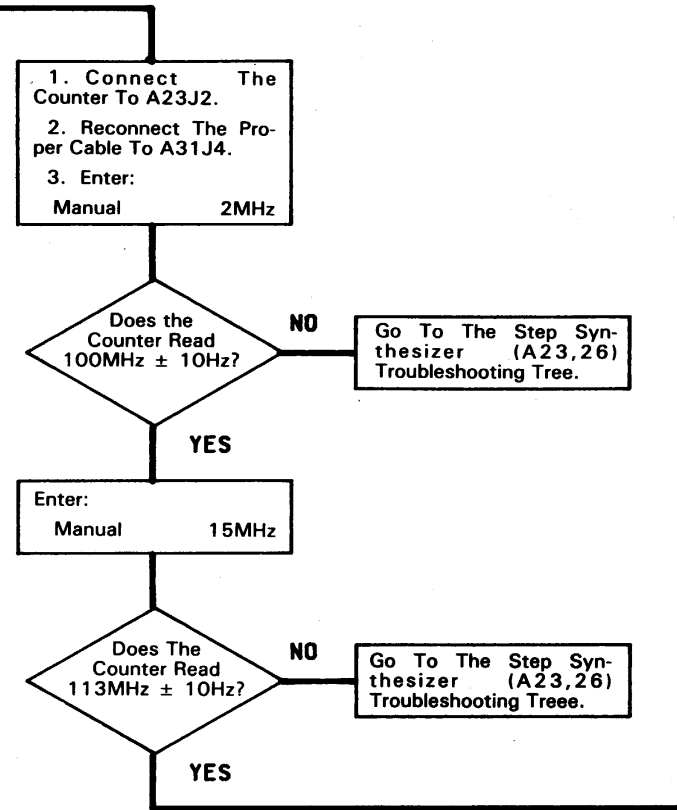
Set-up Conditions:				
Continuous Sweep				
Step and Ref LED off				
Good = blinking; Bad = off or on				
	<b>Res BW = 3KHz</b>	<b>Res BW = 10KHz</b>	<b>Problem Areas</b>	
	<b>FRN</b>	<b>SUM</b>	<b>FRN</b>	<b>(Check Boards In Order Shown)</b>
	Good	Good	Bad	A31, 27, 24, (A32 bias)
	Good	Bad	Good	A24, 25, 27, 28, (A23,26,31)
	Good	Bad	Bad	A27, 24, 22, (A31)
	Bad	Good	Good	A31, (A32 S/H)
	Bad	Good	Bad	A31, 33, 32, 34, A21, (A27)
	Bad	Bad	Good	A31, (A32 S/H)
	Bad	Bad	Bad	A31, 33, 32, 34, A21, (A27)



To The Reference Sec-  
(A21,81) Troubleshooting Tree.

To The Reference Sec-  
(A21,81) Troubleshooting Tree.

To The Fraction N Syn-  
sizer (A31-33) Troubleshooting Tree.





# SERVICE GROUP B-1

## REFERENCE SECTION

Board No. A21,81  
Part Number 03585-66521; 03585-66581

### INDEX:

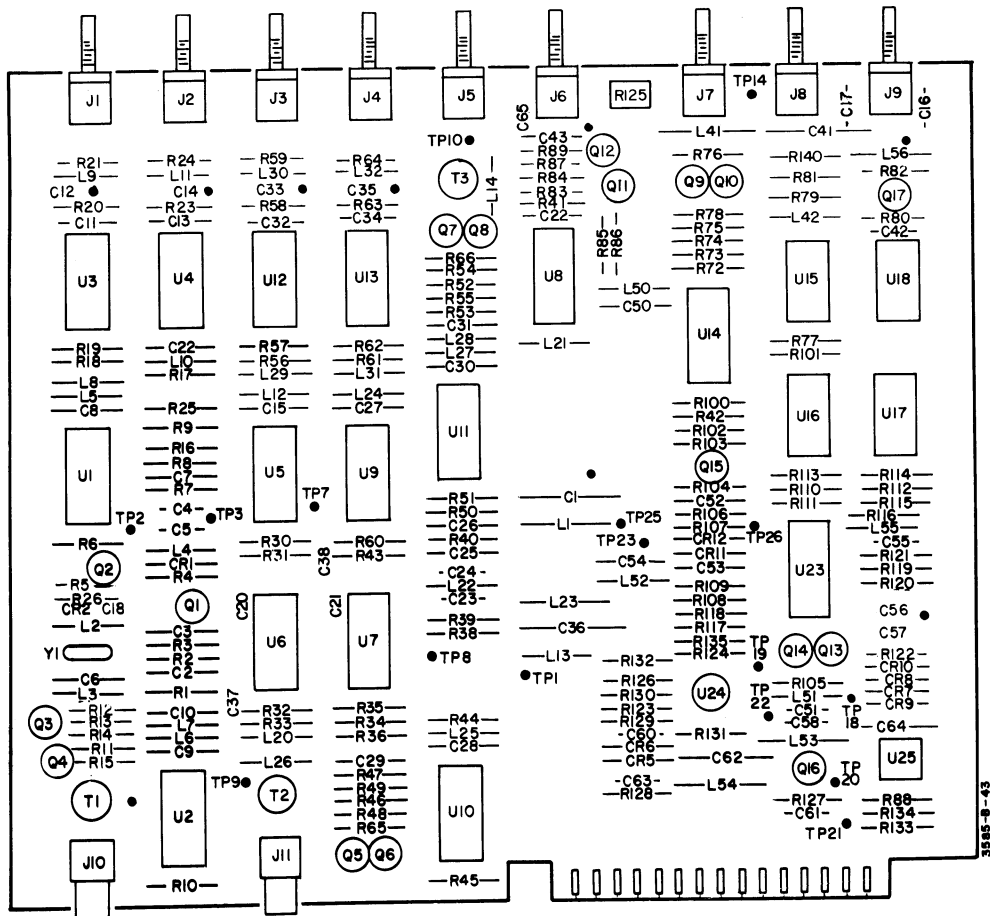
Title	Page No.
Reference Section (A21,A81) Troubleshooting Tree.....	11-155/11-156
A81 Oven Reference Troubleshooting Tree.....	11-159/11-160

### ADJUSTMENTS:

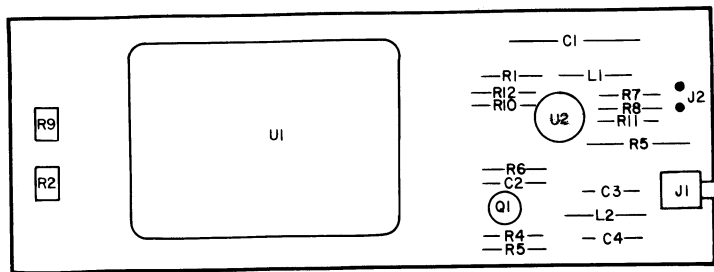
Component	Adjusted Parameter	Paragraph Location
A21R125	90HMz Center Frequency	5-7
A81R9	Oven Output Shut-off Control	5-8
A81U1	Course Oven Frequency	5-9
A81R2	Fine Oven Frequency	5-9

### TROUBLESHOOTING NOTES:

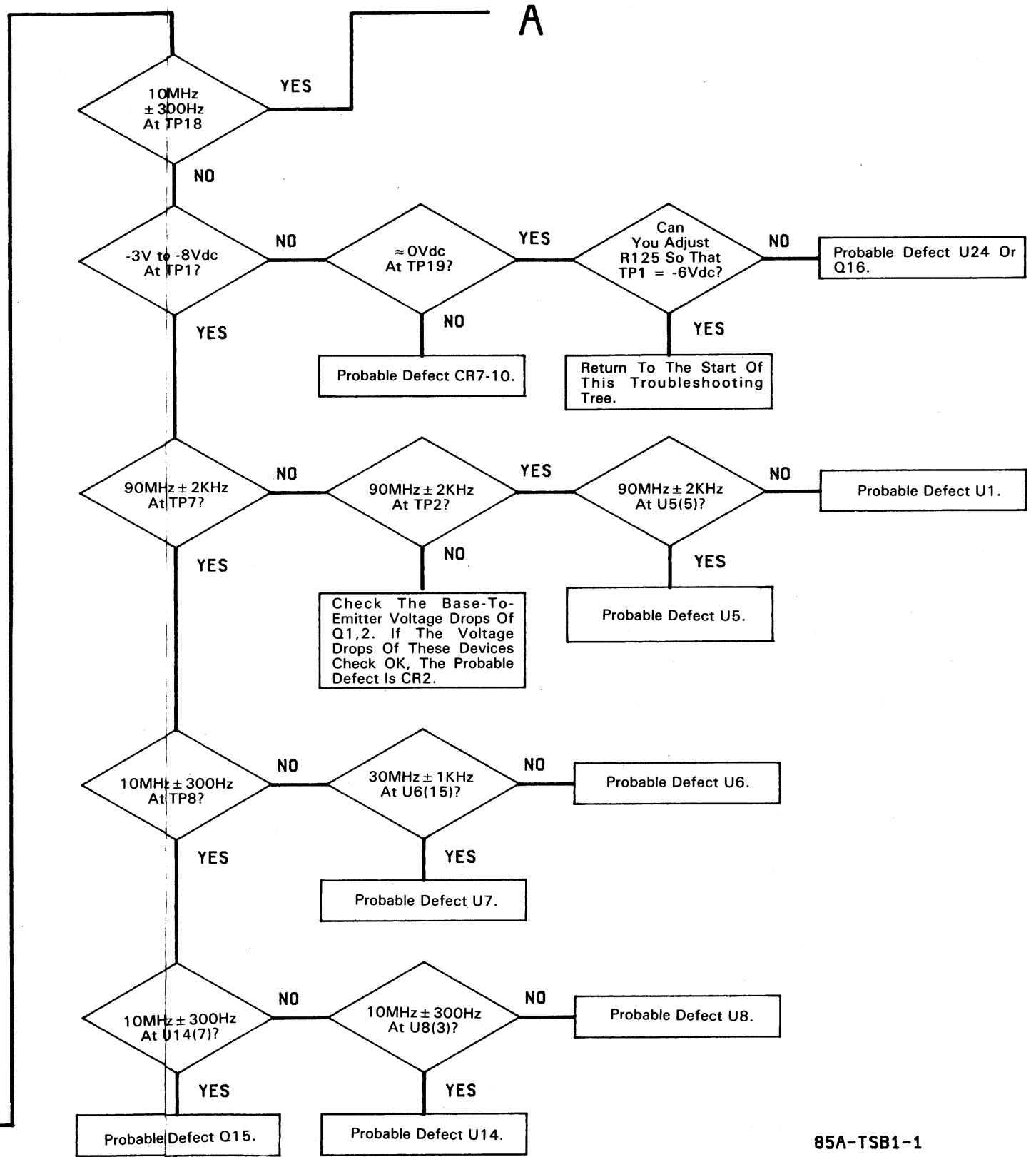
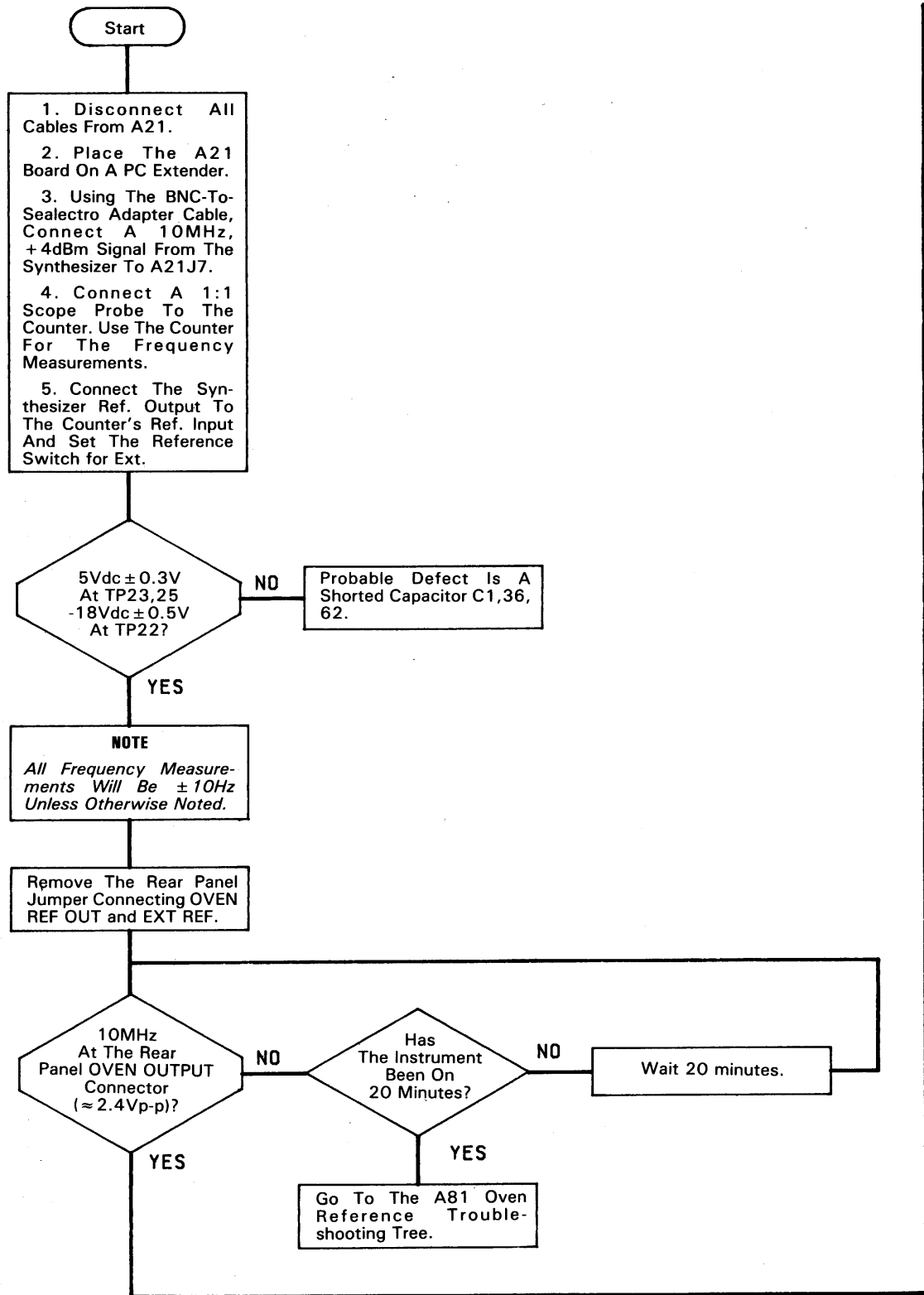
None



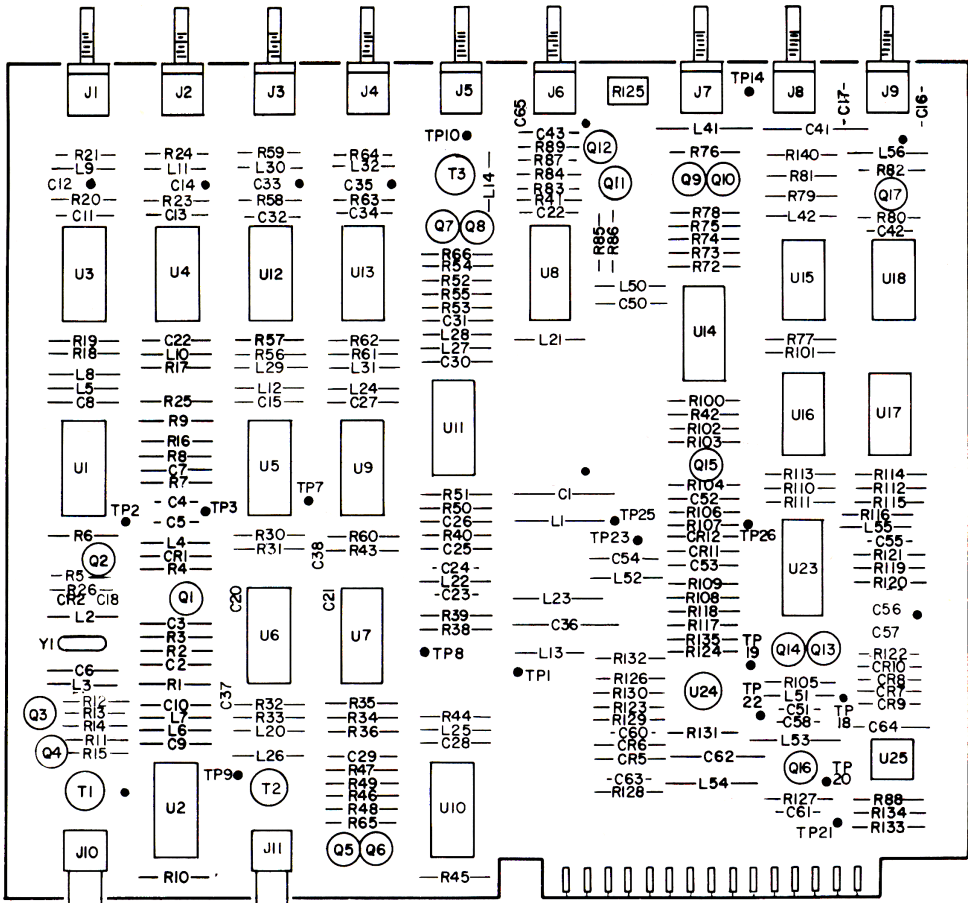
A21  
03585-66521



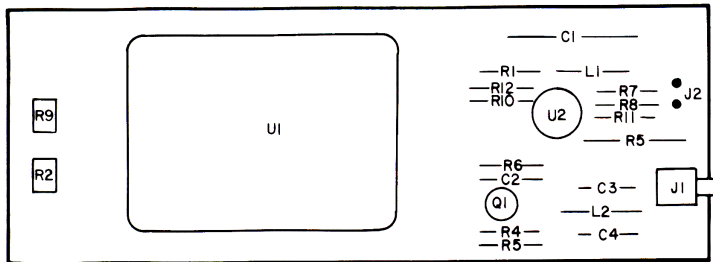
A81  
03585-66581



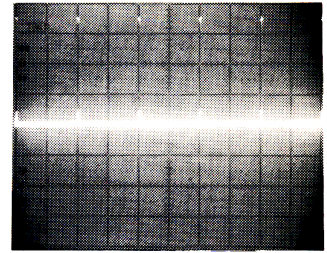
85A-TSB1-1



**A21**  
03585-66521

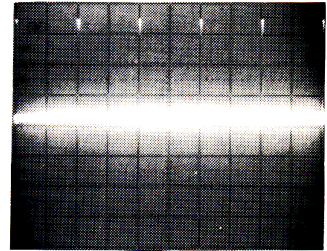


**A81**  
03585-66581



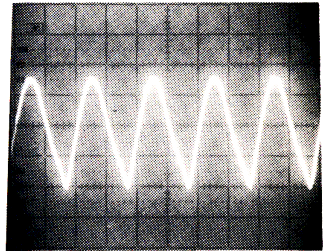
0.5V/DIV

5μsec/DIV



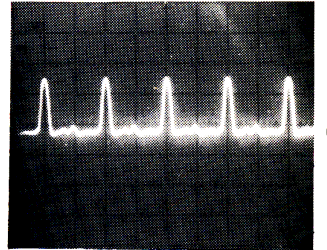
1V/DIV

5μsec/DIV



0.05V/DIV

0.05μsec/DIV

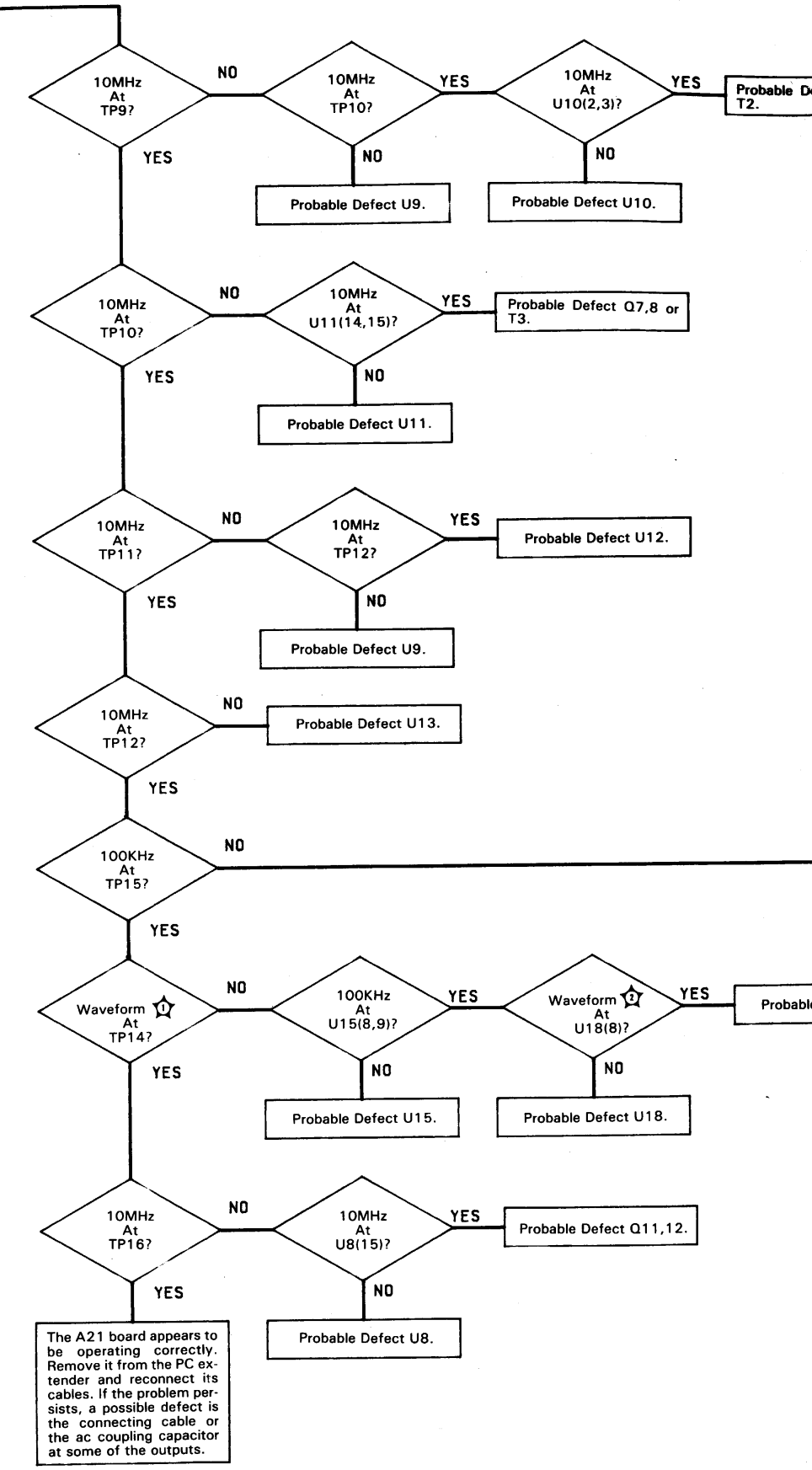
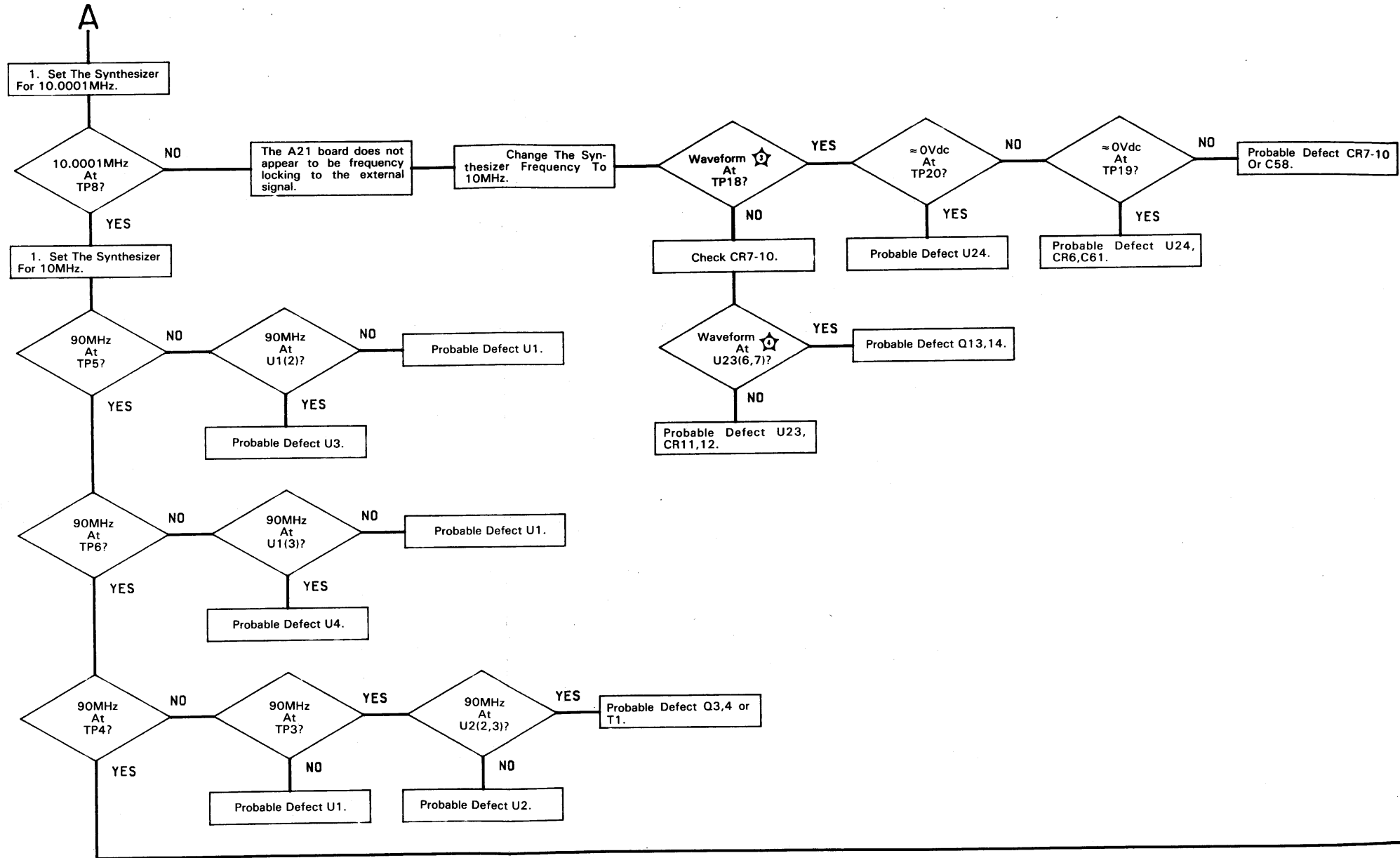


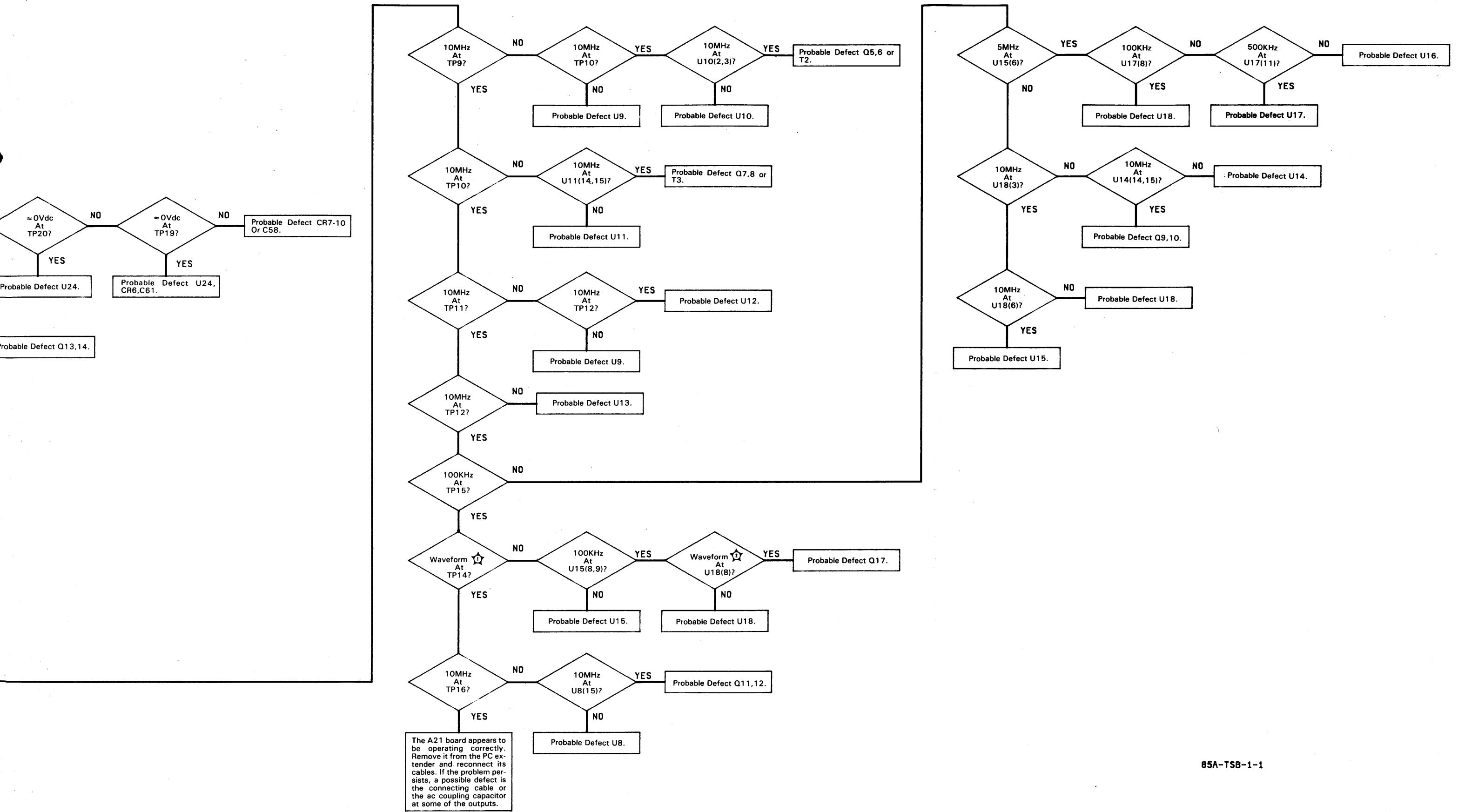
0.5V/DIV

0.05μsec/DIV

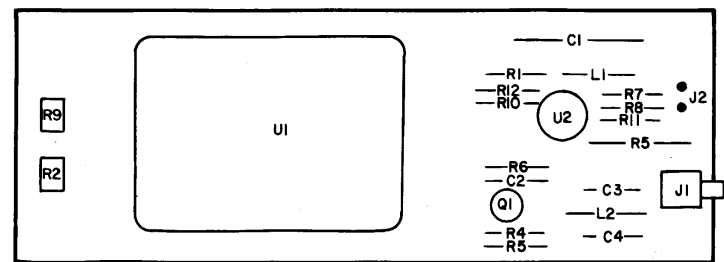
NOTE

If you entered this tree and the REF LED on the A34 board was on, Probable Defect is U21 if TP21 is >0.8Vdc. If TP21 measures 0Vdc and the REF is still on, the Probable Defect is A34U12.

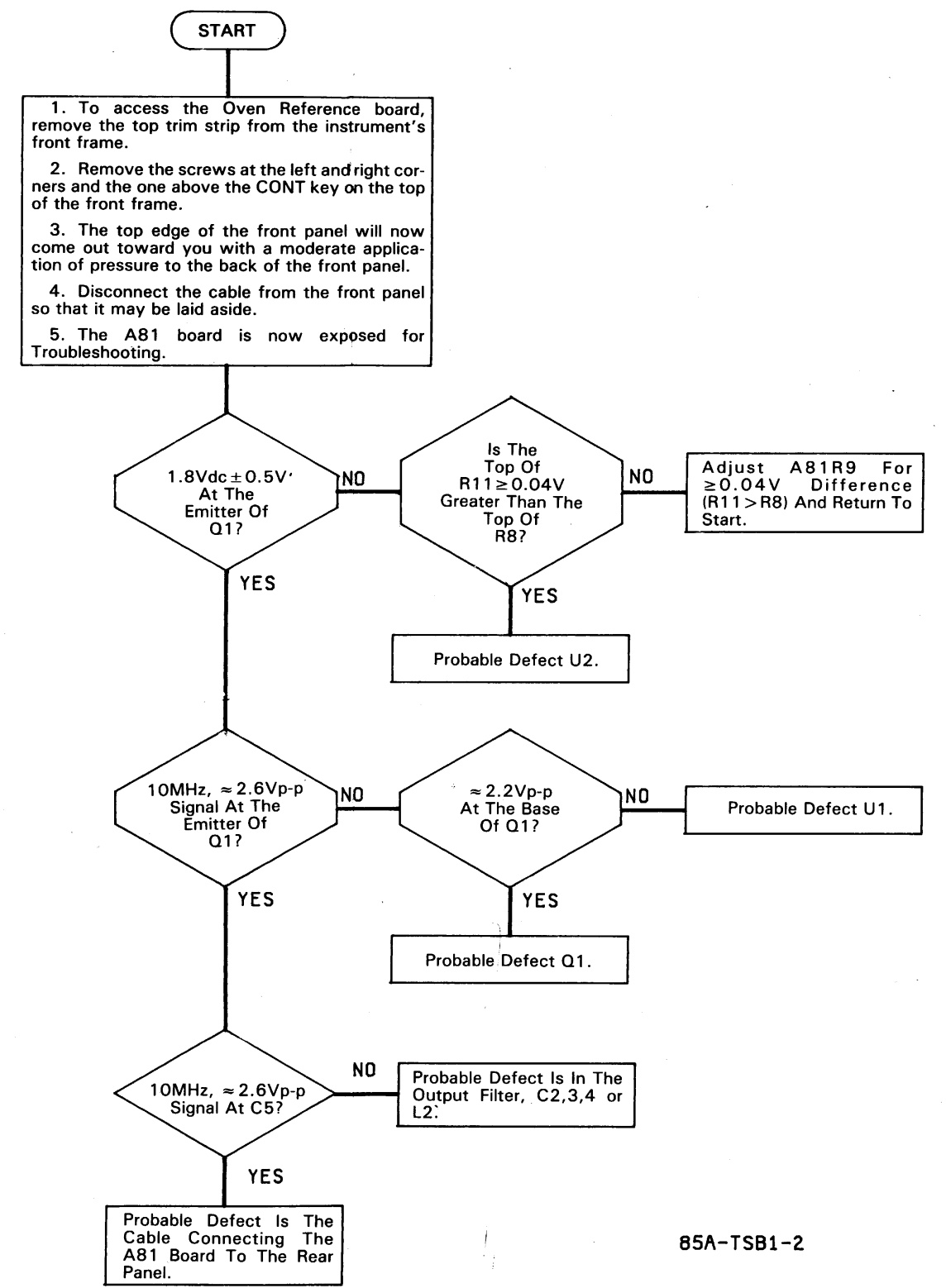




The A21 board appears to be operating correctly. Remove it from the PC extender and reconnect its cables. If the problem persists, a possible defect is the connecting cable or the ac coupling capacitor at some of the outputs.



A81  
03585-86581



85A-TSB1-2

# SERVICE GROUP B-2

## SUM LOOP

Board Numbers A22,24,25,27,28

Part Numbers 03585-66522,-66524,-66525,-66527,-66528

### INDEX:

Title	Page No.
Sum Loop Troubleshooting Tree.....	11-163/11-164
A22 First LO VTO Troubleshooting Tree.....	11-165/11-166
A25 Sum Loop Mixer Troubleshooting Tree.....	11-169/11-170
A27 First Lo VTO Control Troubleshooting Tree.....	11-171/11-172
A28 Sum Loop Phase Detector Troubleshooting Tree.....	11-167/11-168

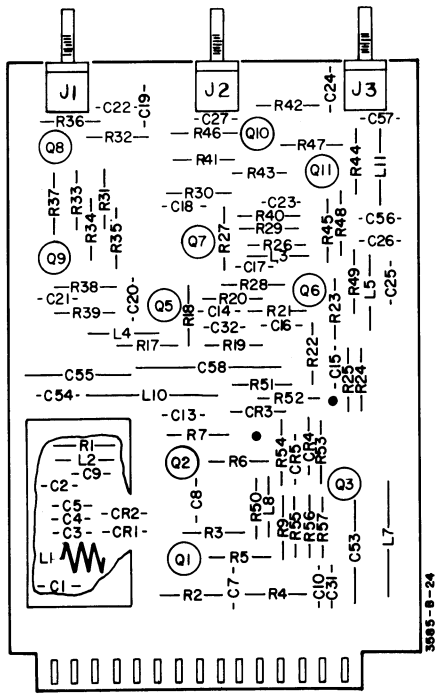
### ADJUSTMENTS:

Component	Adjusted Parameter	Paragraph Location
A22L1	VTO Frequency	5-15
A27R2	Sum Loop Initial Point	5-15
A27R11	Slope	5-15

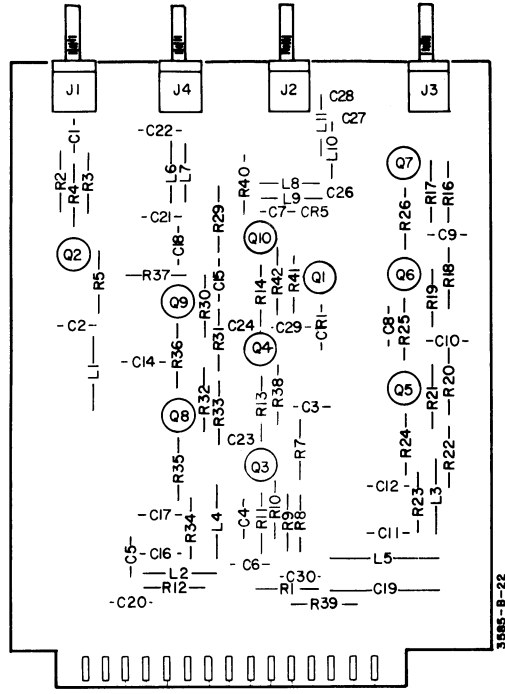
### TROUBLESHOOTING NOTES:

1. When troubleshooting the A22 board it is very important to use the 20:1 resistive divider probe. This probe has very low capacitance and a minimal effect on this sensitive oscillator circuit.
2. Use care when probing the A22 board. The capacitance added by your fingers touching the board can inhibit oscillator operation.
3. In most cases, the amplitude will be correct if the frequency is correct; therefore, it is only necessary to check the frequency.

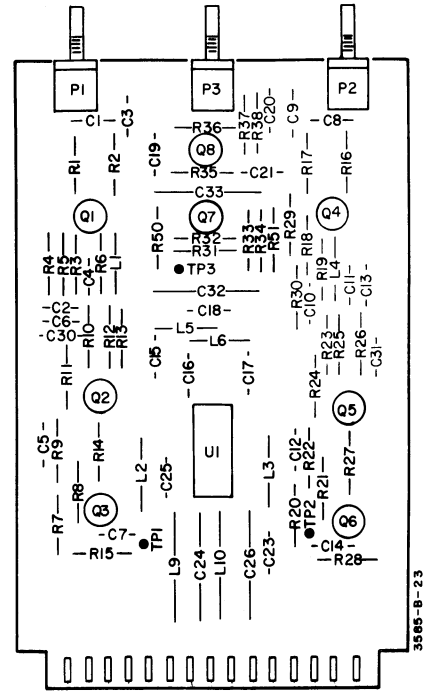




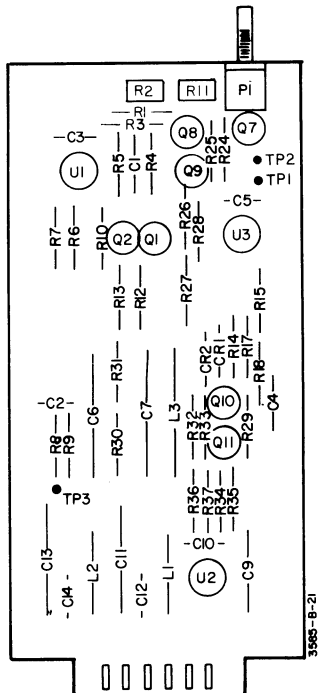
A22  
03585-66522



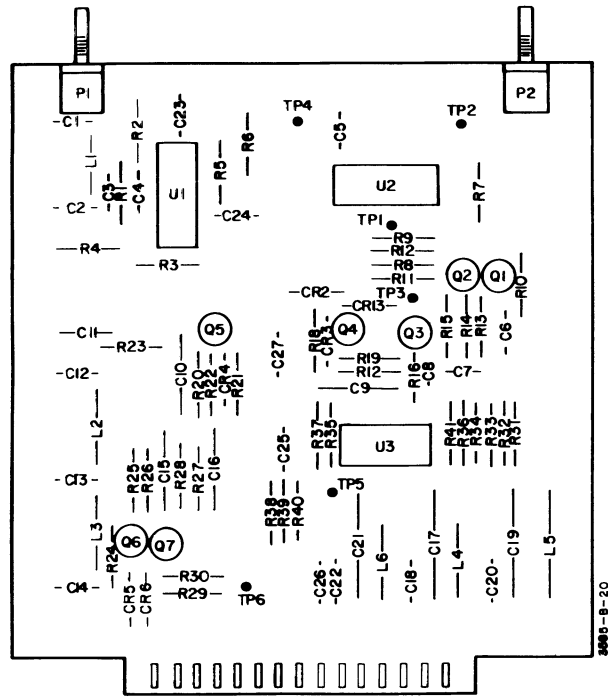
A24  
03585-66524



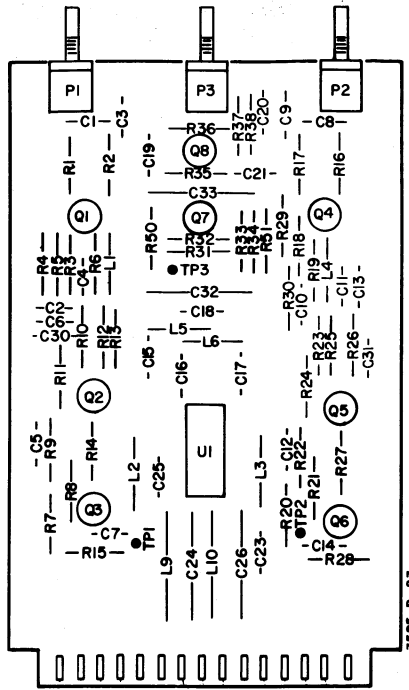
A25  
03585-66525



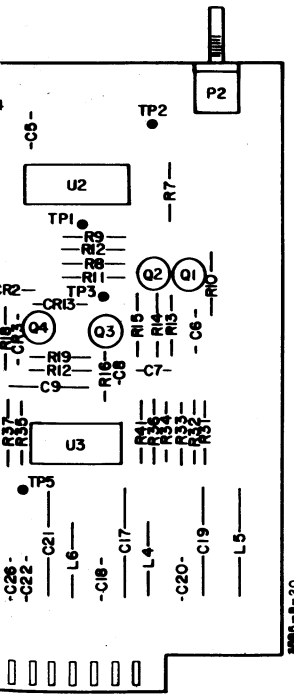
A27  
03585-66527



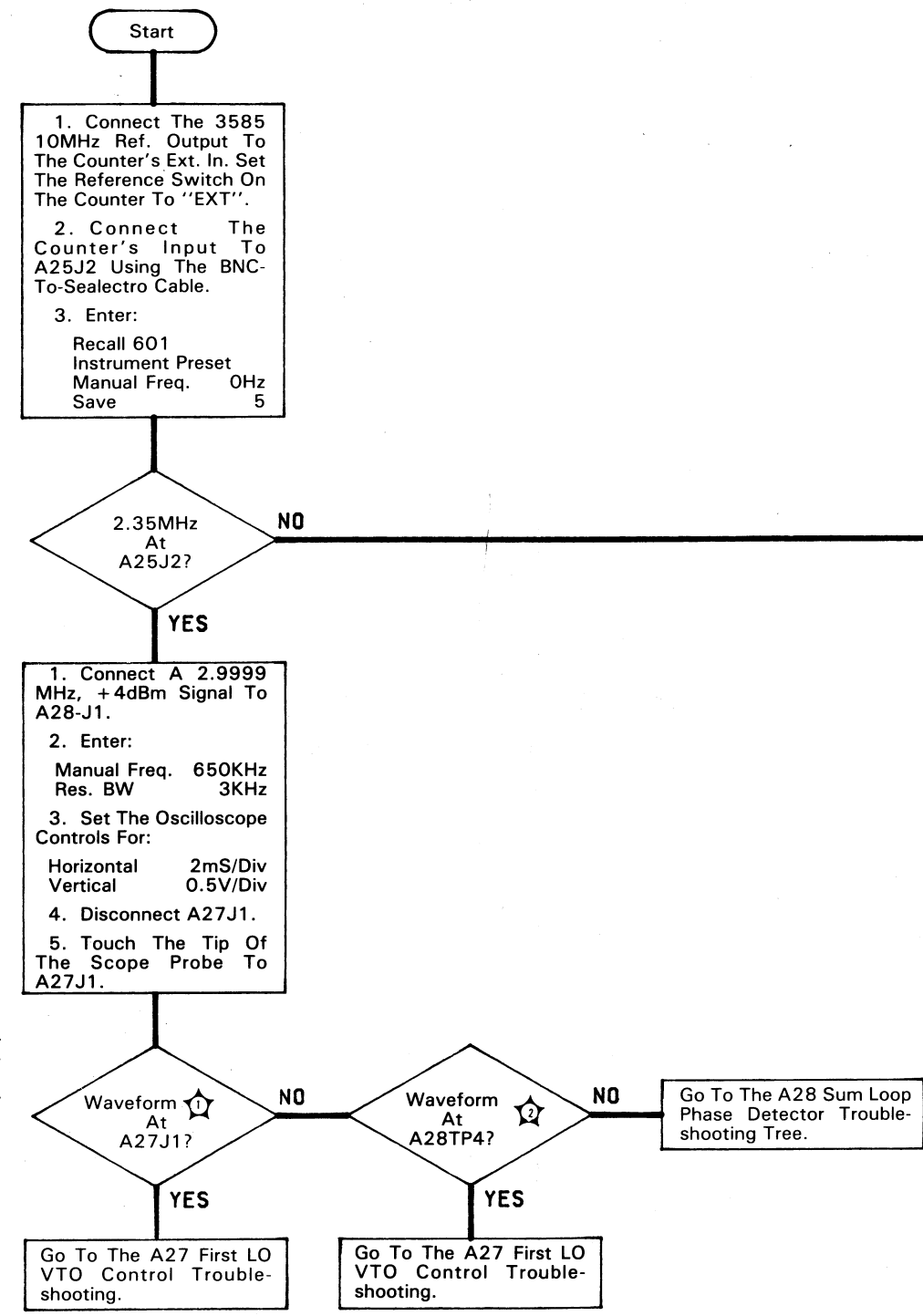
A28  
03585-66528



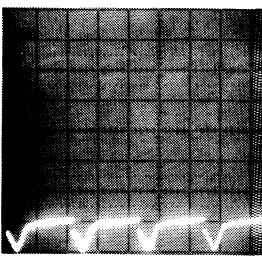
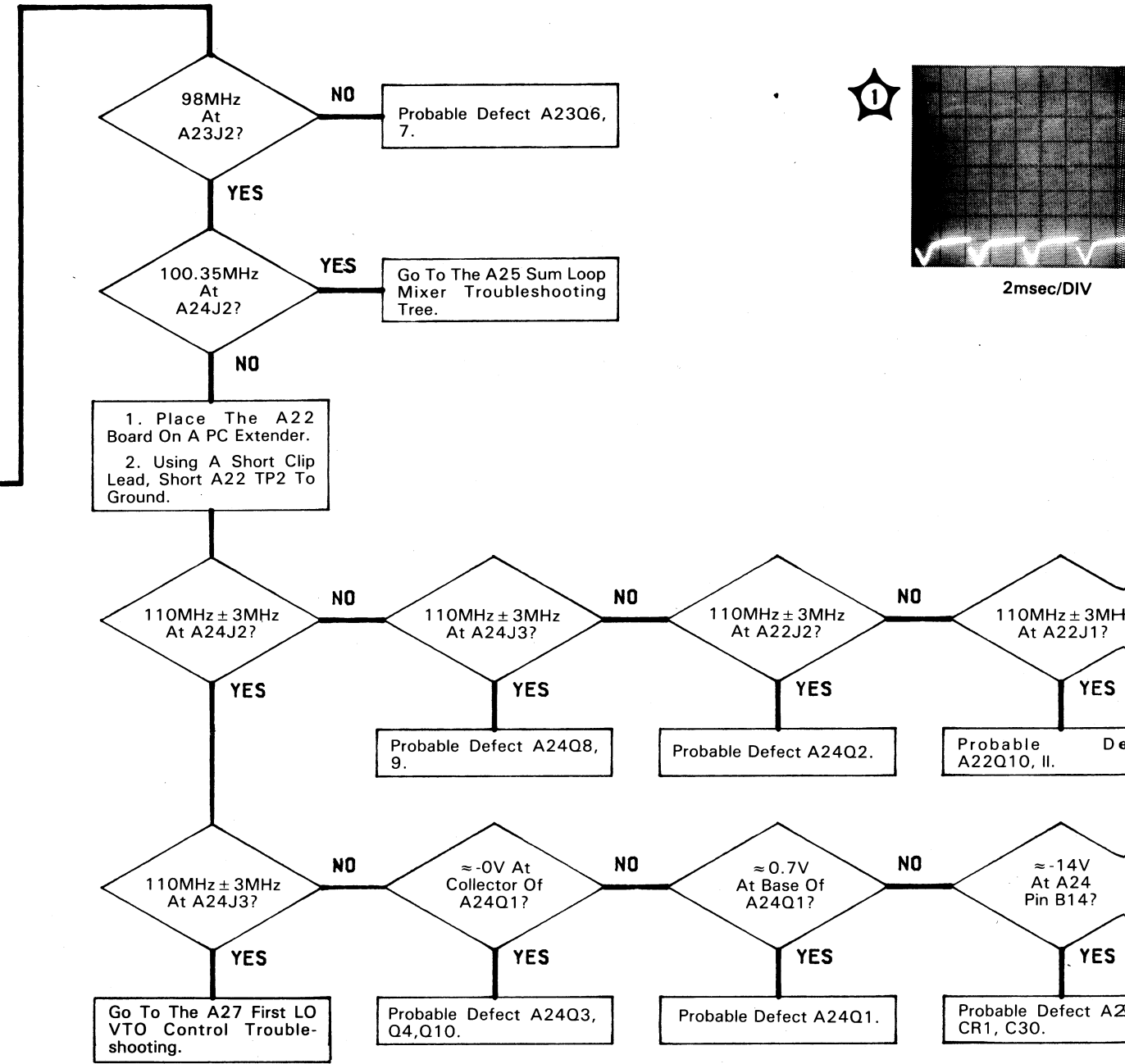
A25  
03585-66525



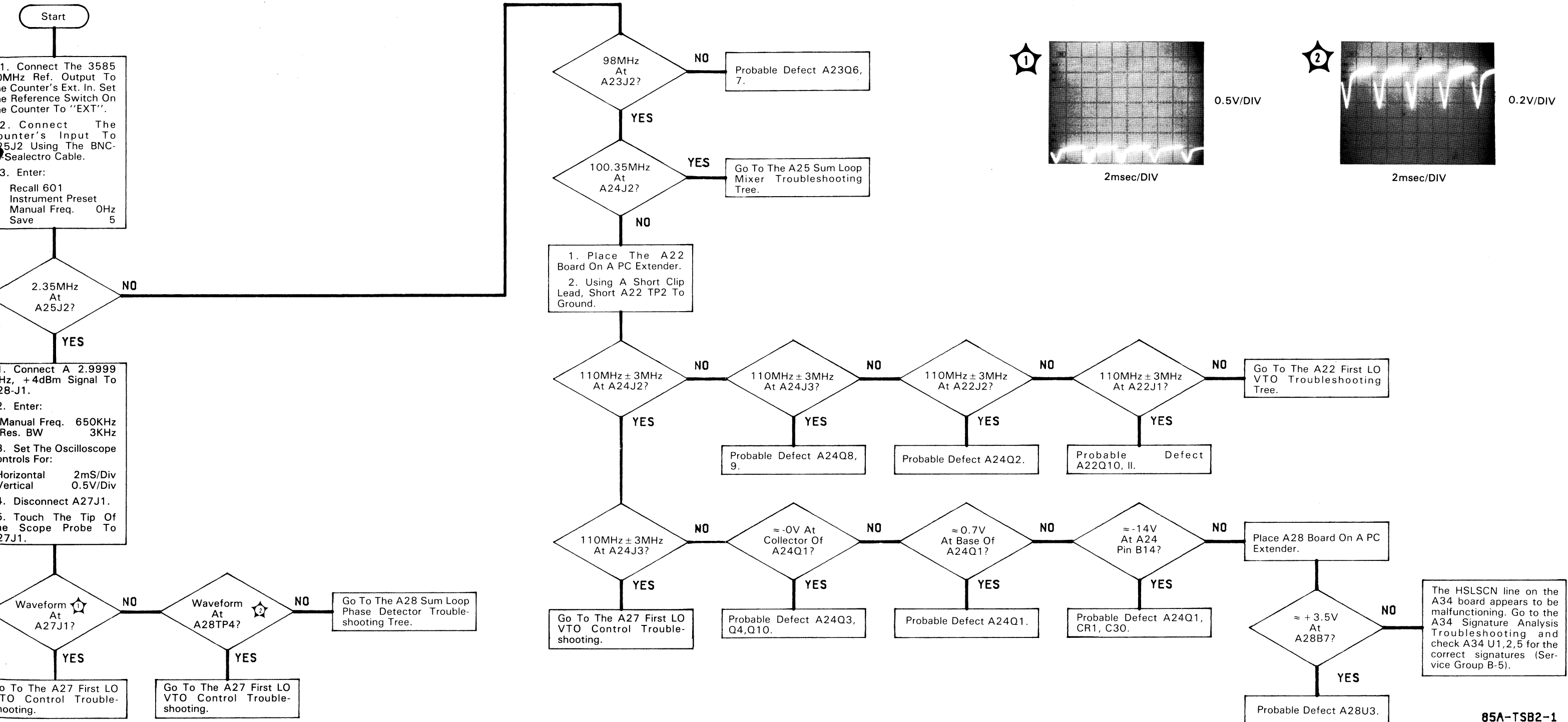
A27  
03585-66528

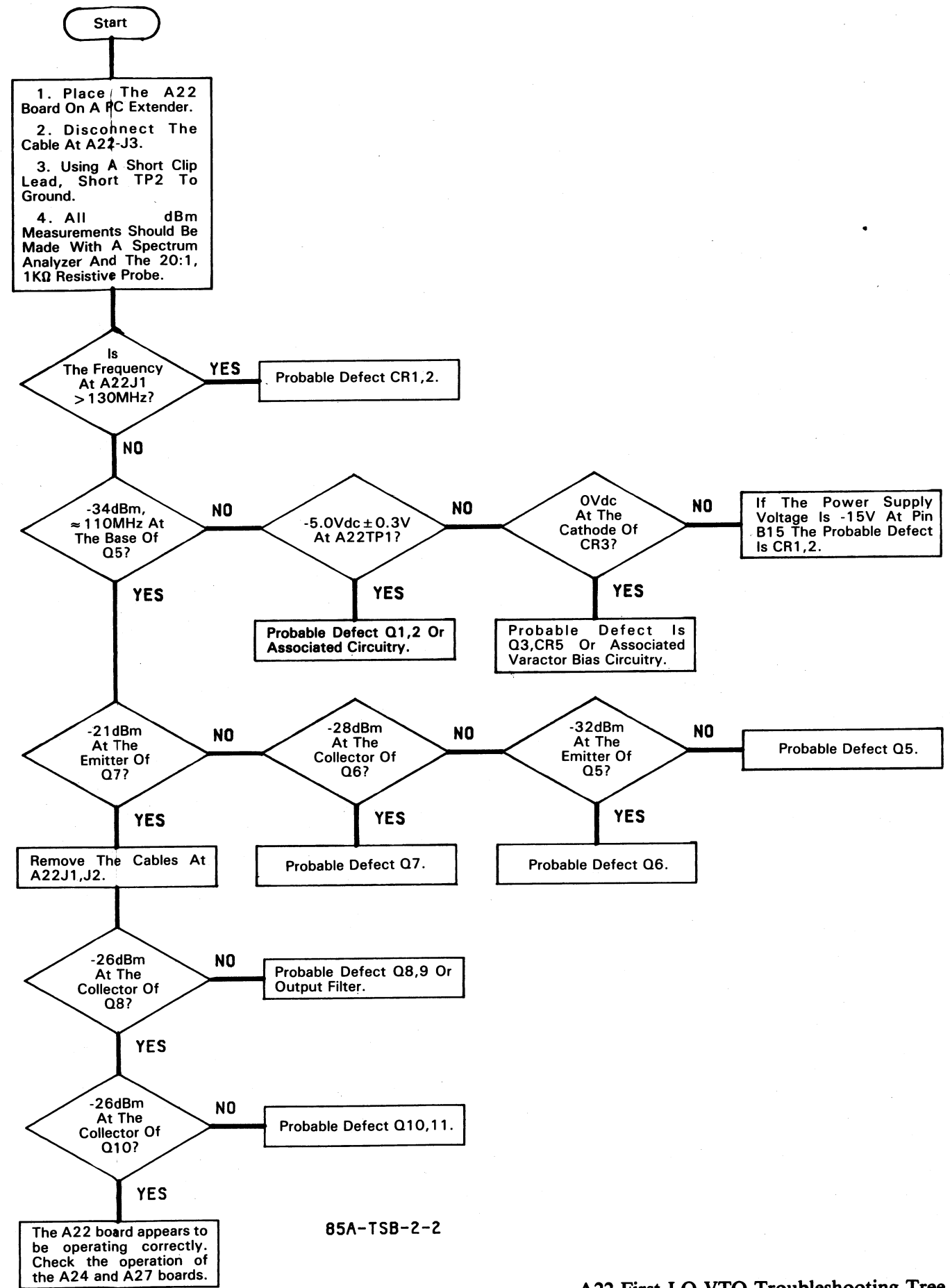
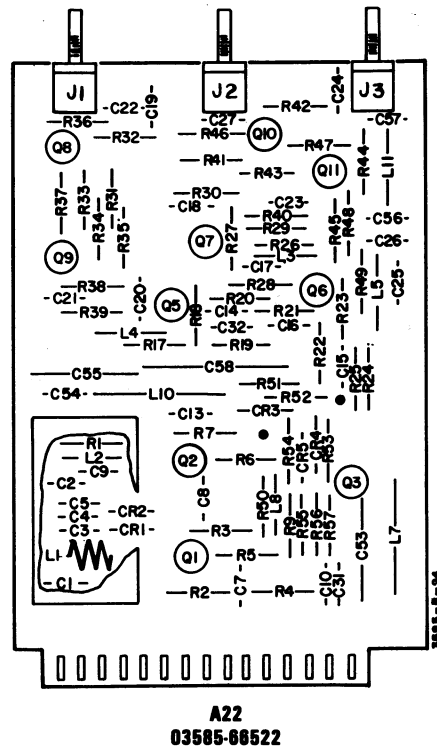


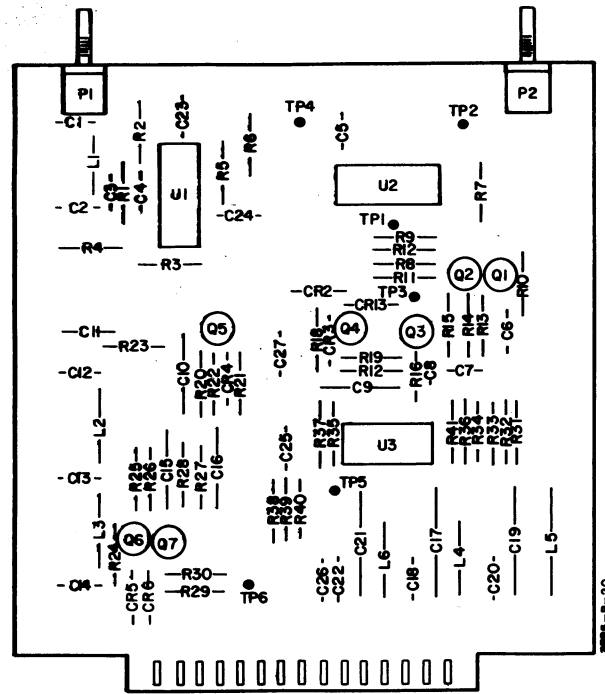
**NOTE**  
By varying the synthesizer's frequency by several hundred Hz, you should be able to obtain the waveforms that you are asked to check.



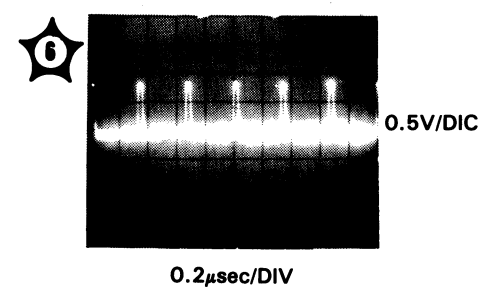
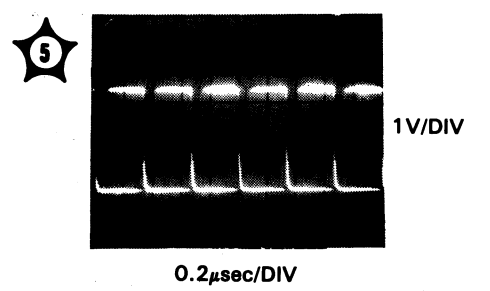
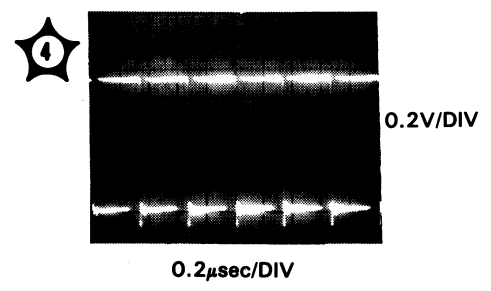
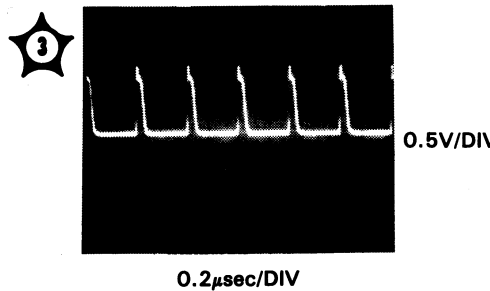
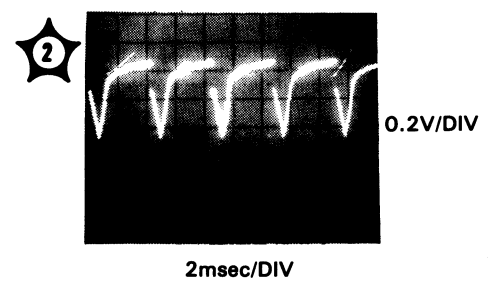
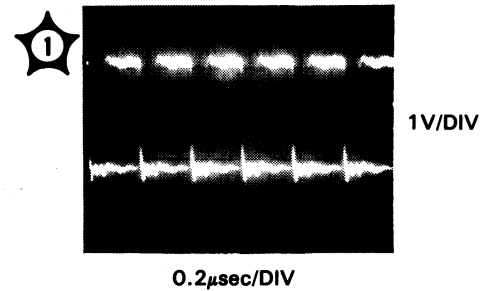
2msec/DIV





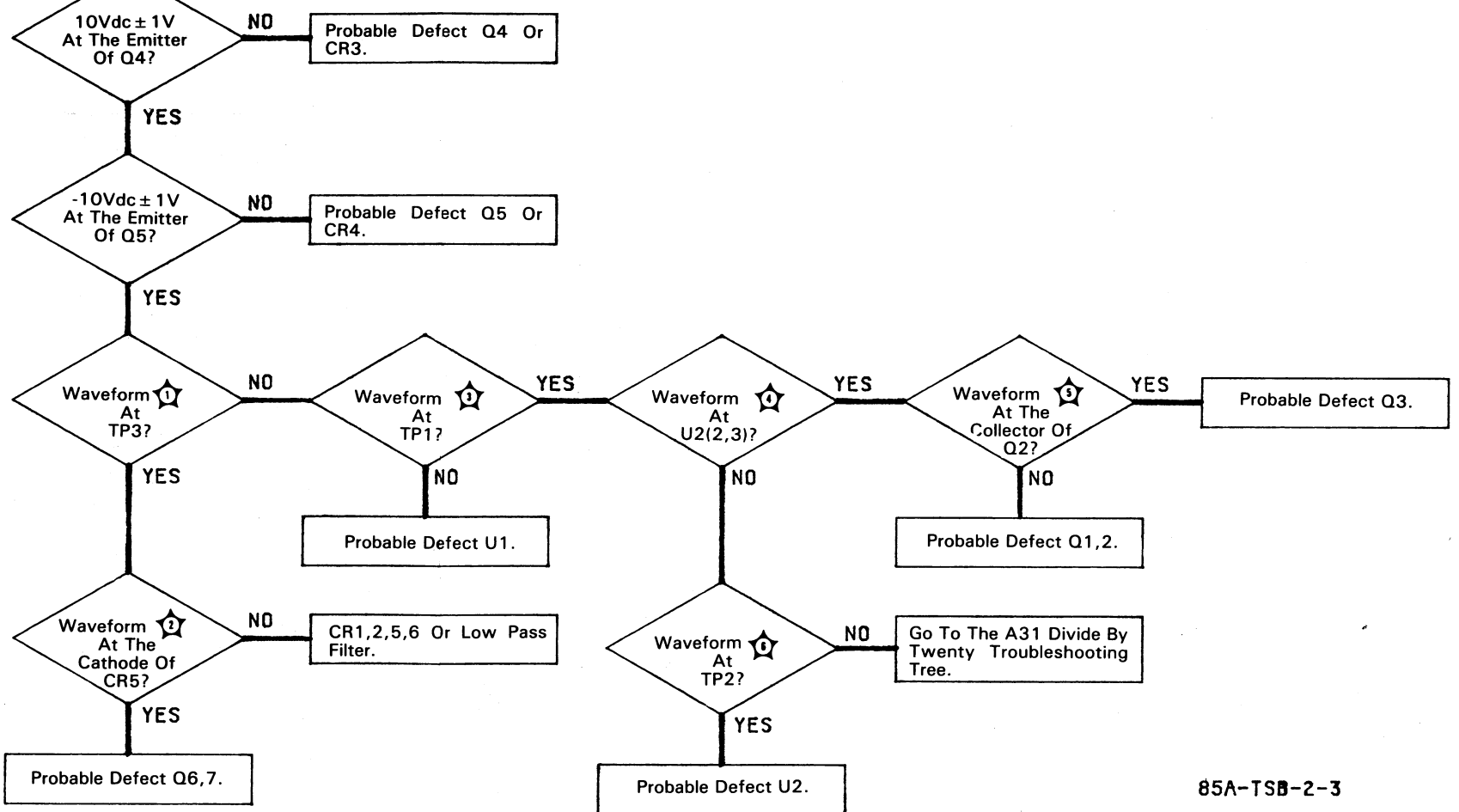


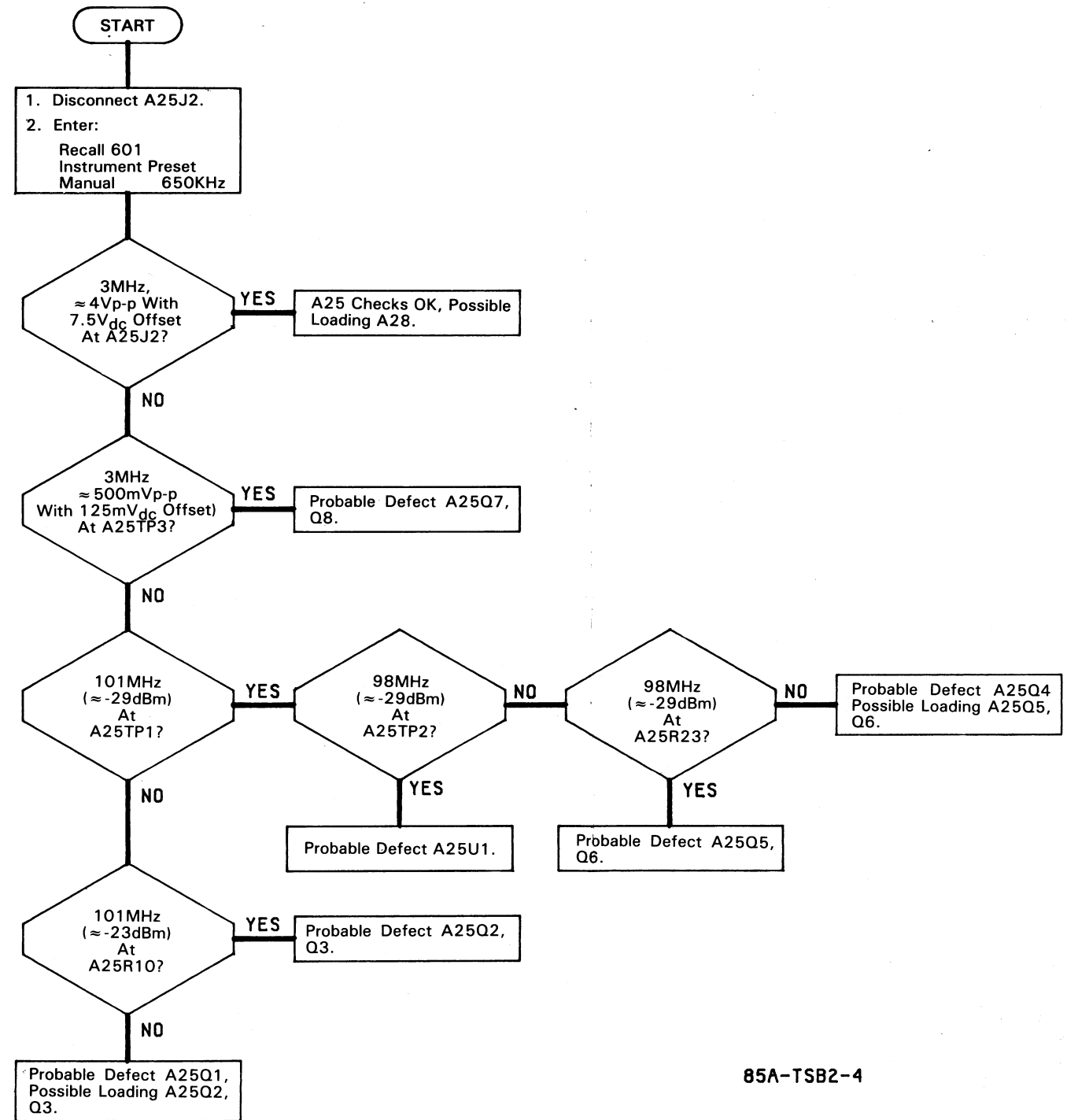
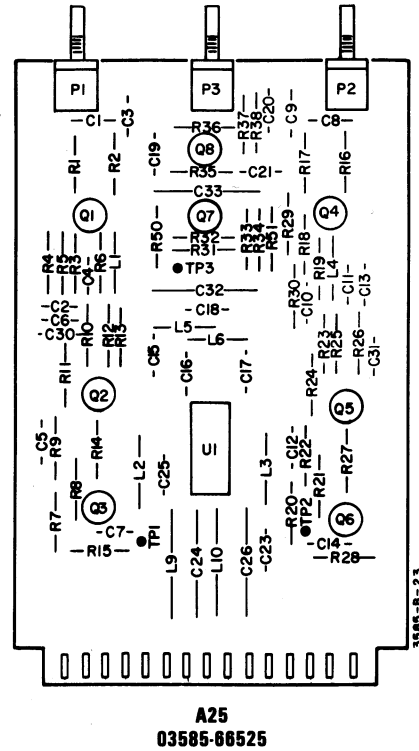
A28  
03585-66528



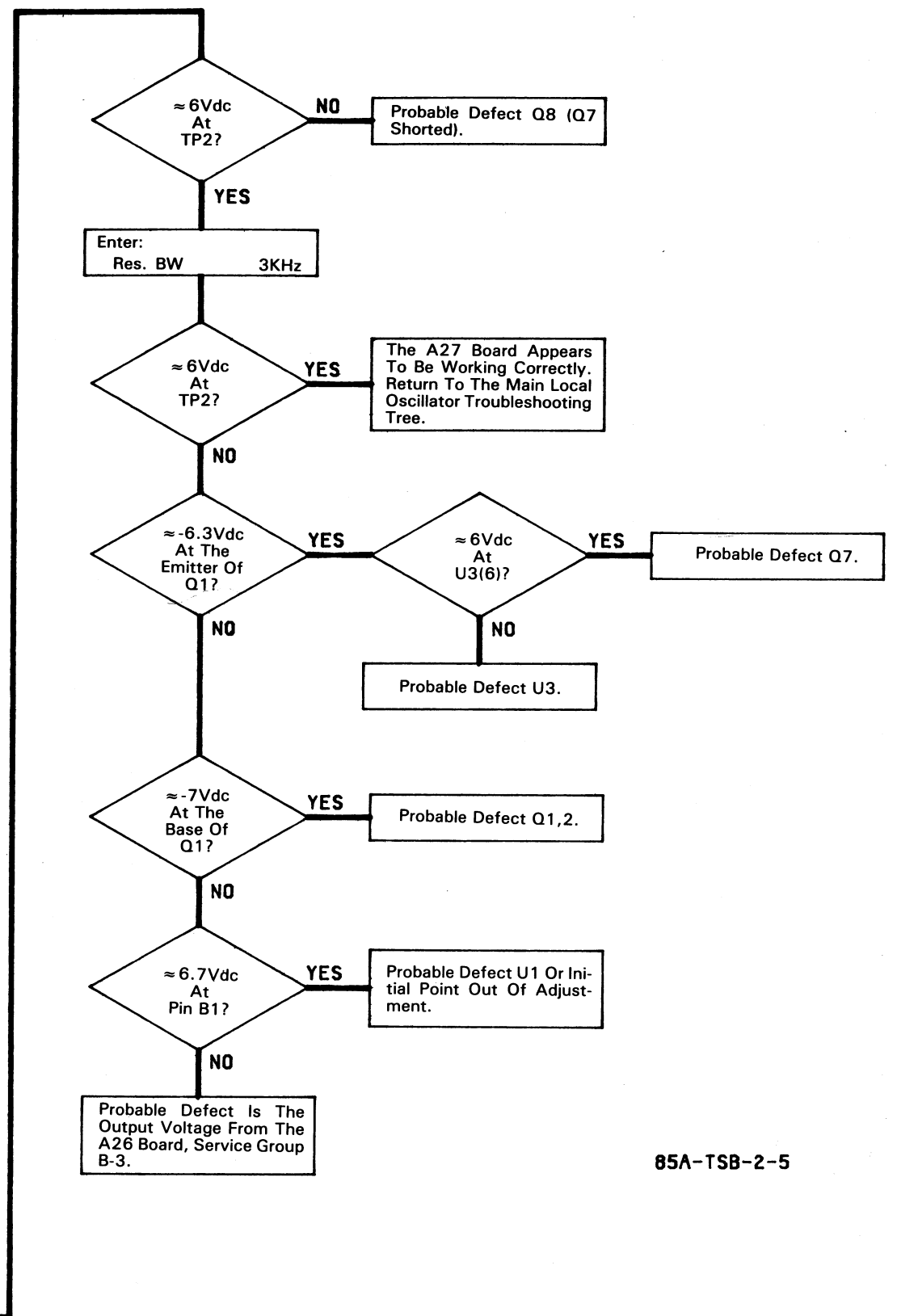
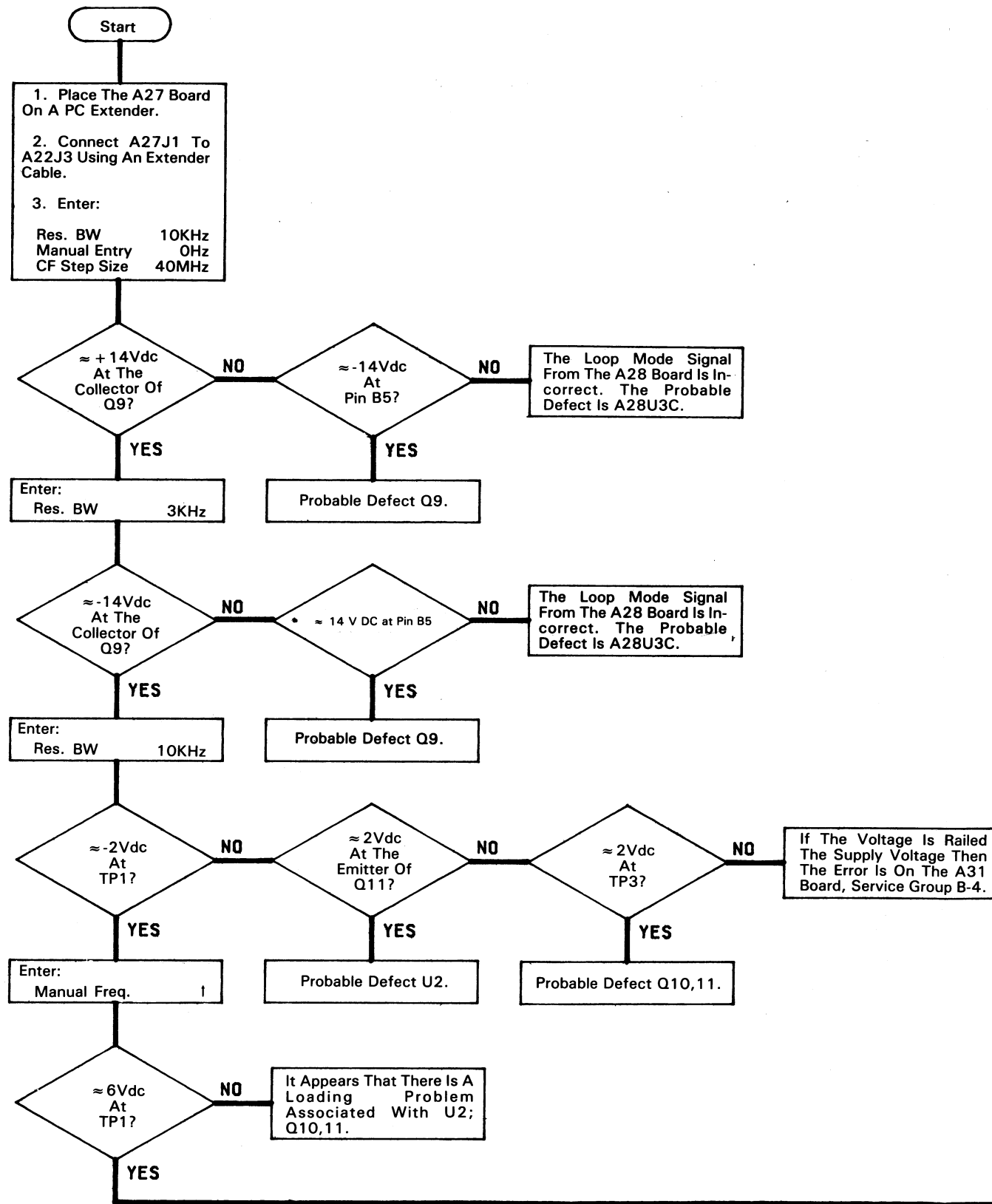
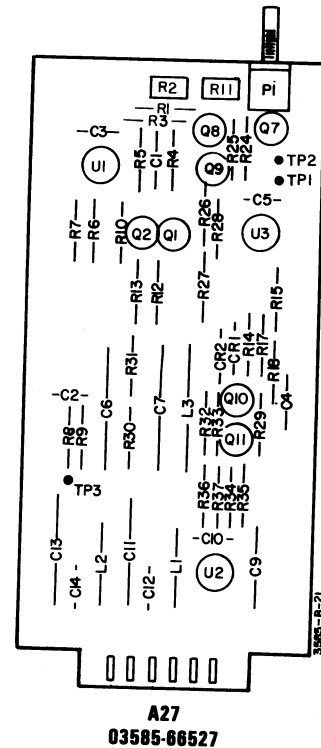
- Start
1. Place the A28 board on a PC extender.
  2. Connect A31J4 to A28J2 with an extender cable.
  3. Connect a 2.9999MHz, +4dBm signal to A28J1.
  4. Enter:  
Manual 650KHz  
Res BW 3KHz  
Save 5
  5. Set the oscilloscope controls for:  
Horizontal  
Vertical

**NOTE**  
By varying the synthesizer's frequency several hundred Hz, you should be able to obtain the waveforms that you are asked to check.





85A-TSB2-4



85A-TSB-2-5

# SERVICE GROUP B-3

## STEP LOOP SYNTHESIZER

Board Numbers A23, A26  
Part Numbers 03585-66523 and 03485-66526

### INDEX:

Title	Page No.
Step Loop Synthesizer (A23,26) Troubleshooting Tree . . . . .	11-175/11-176
A26 Mixer Circuitry Troubleshooting Tree . . . . .	11-177
A26 Reference Divider Troubleshooting Tree . . . . .	11-178
A26 Divide By N Troubleshooting Tree . . . . .	11-179/11-180
A23 Step Synthesizer VTO Troubleshooting Tree . . . . .	11-181/11-182

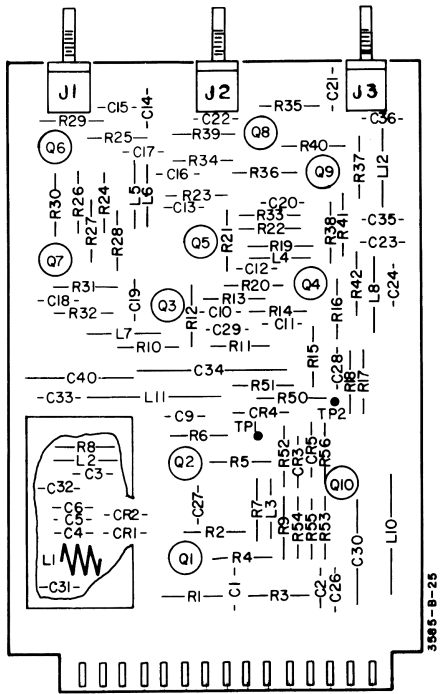
### ADJUSTMENTS:

Component	Adjusted Parameter	Paragraph Location
A23L1	VTO Frequency	5-14
A26R75	Clamp Voltage Reference	5-14

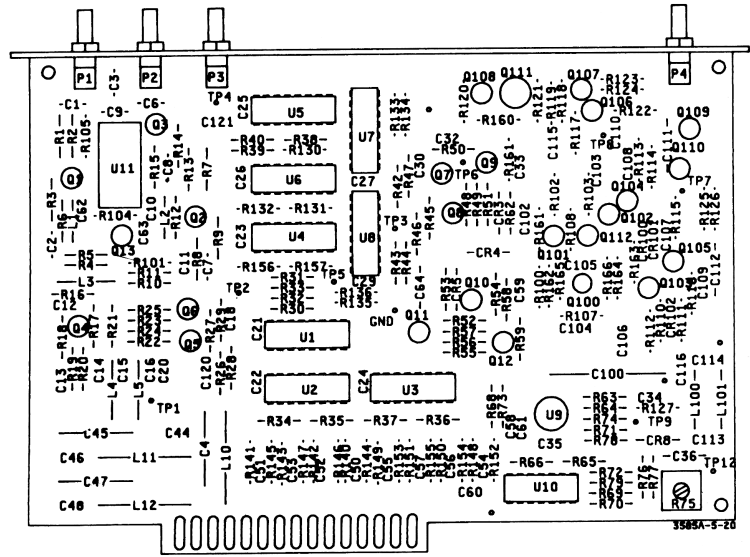
### TROUBLESHOOTING NOTES:

1. When troubleshooting the A23 board it is very important to use the 20:1 resistive divider probe has very low capacitance and a minimal effect on this sensitive oscillator circuit.
2. Use care when probing the A23 board. The capacitance added by your fingers touching the board can inhibit oscillator operation.

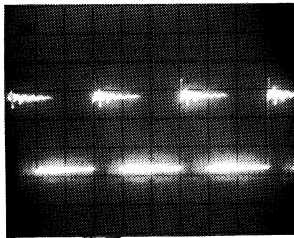




**A23**  
03585-66523

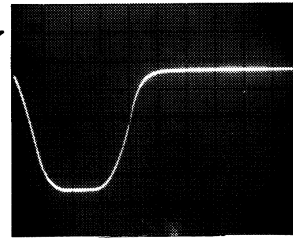


**A26**  
03585-66526



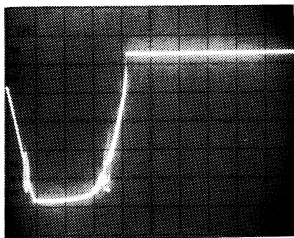
1 volts/DIV

0.2  $\mu$ sec/DIV



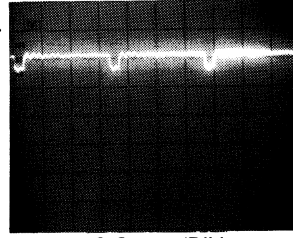
5 volts/DIV

10 msec/DIV



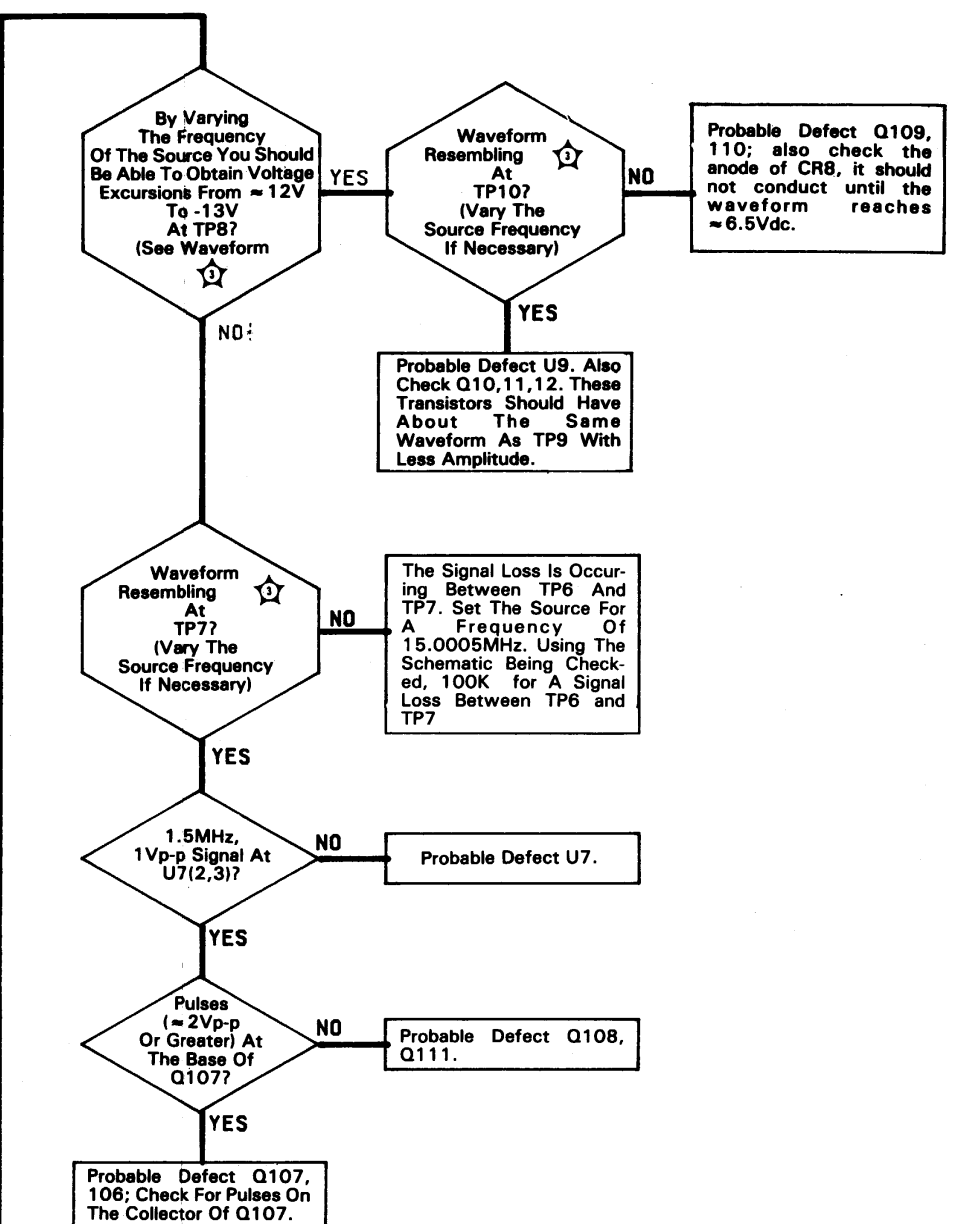
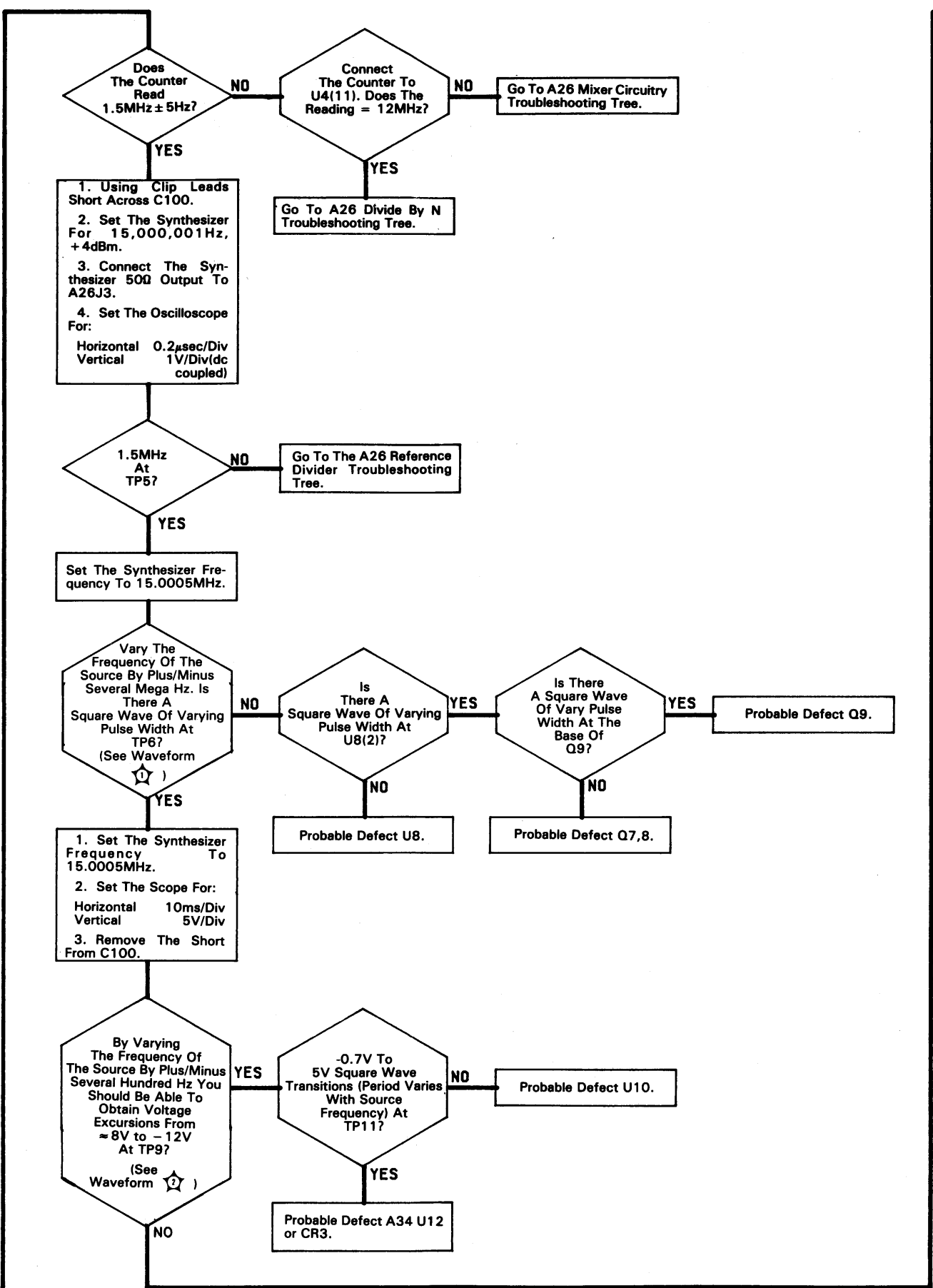
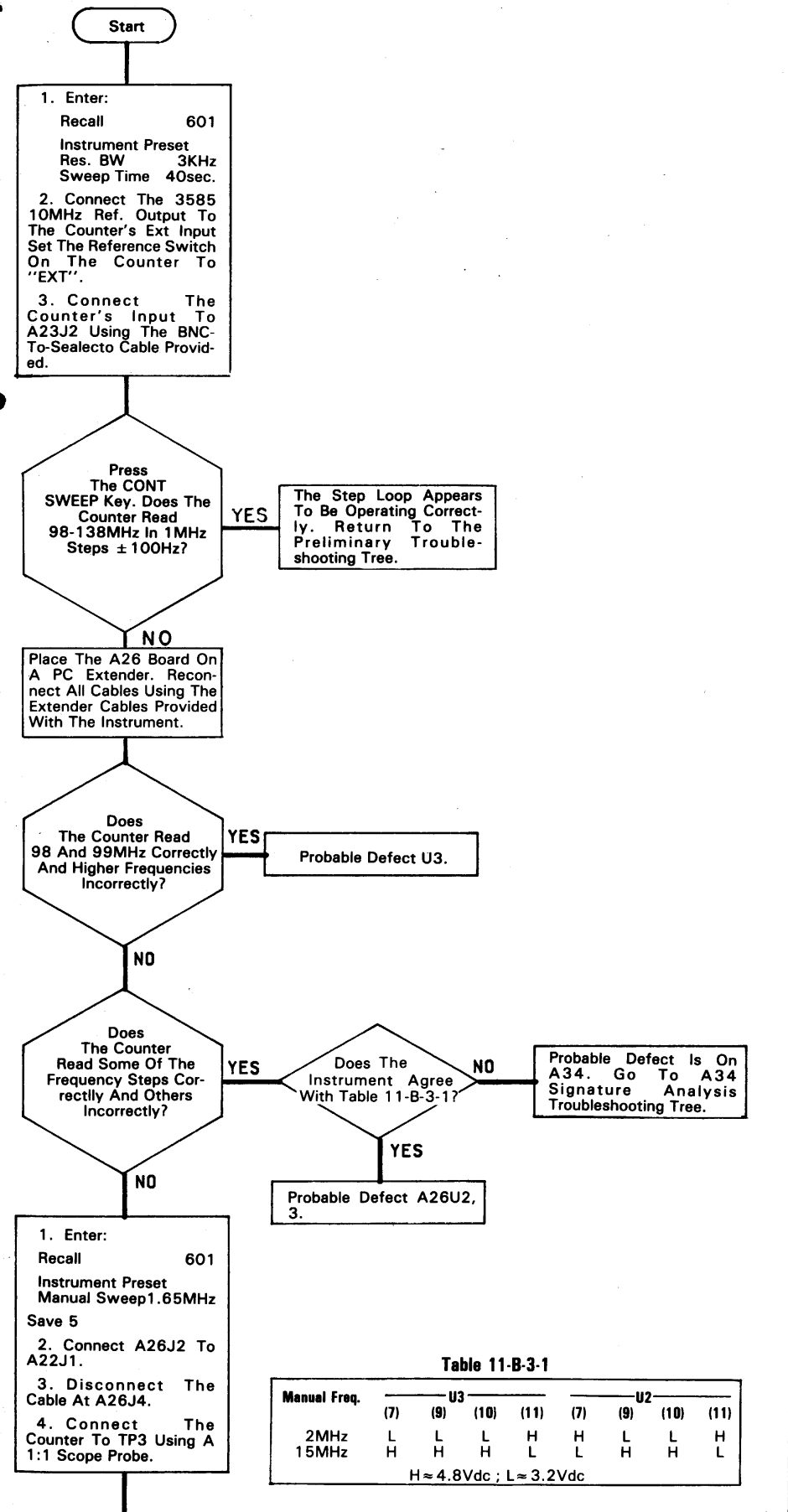
5 volts/DIV

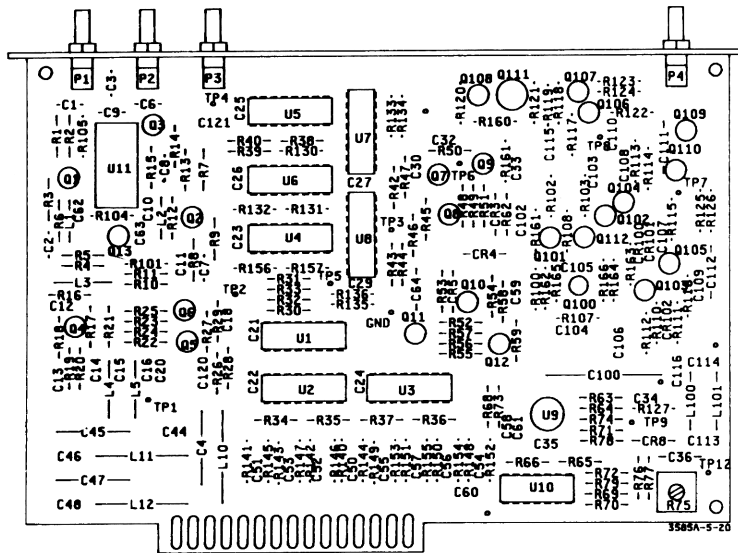
10 msec/DIV



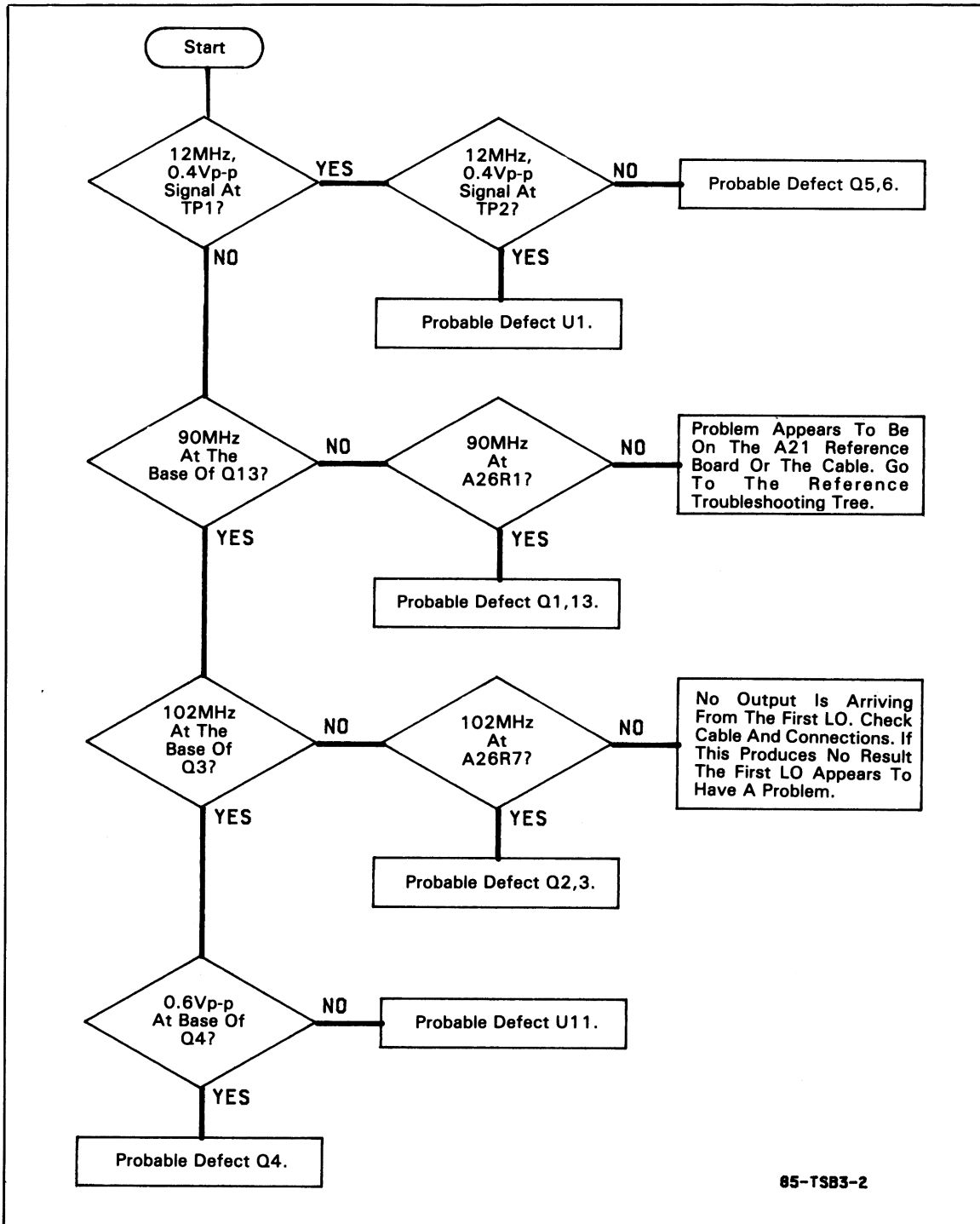
2 volts/DIV

0.2  $\mu$ sec/DIV

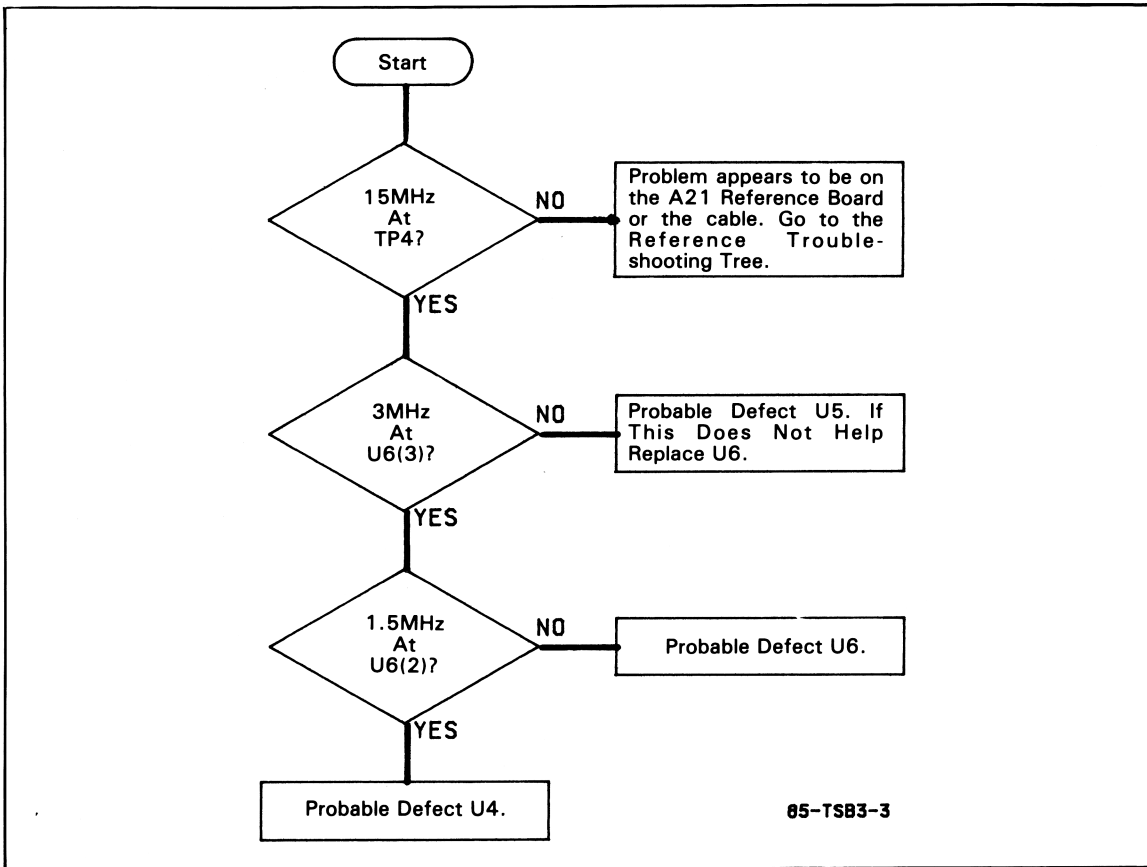




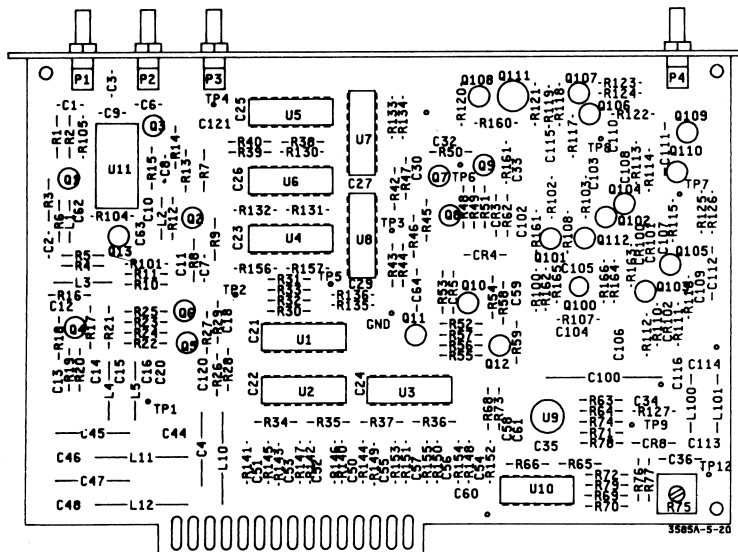
A26  
03585-66526



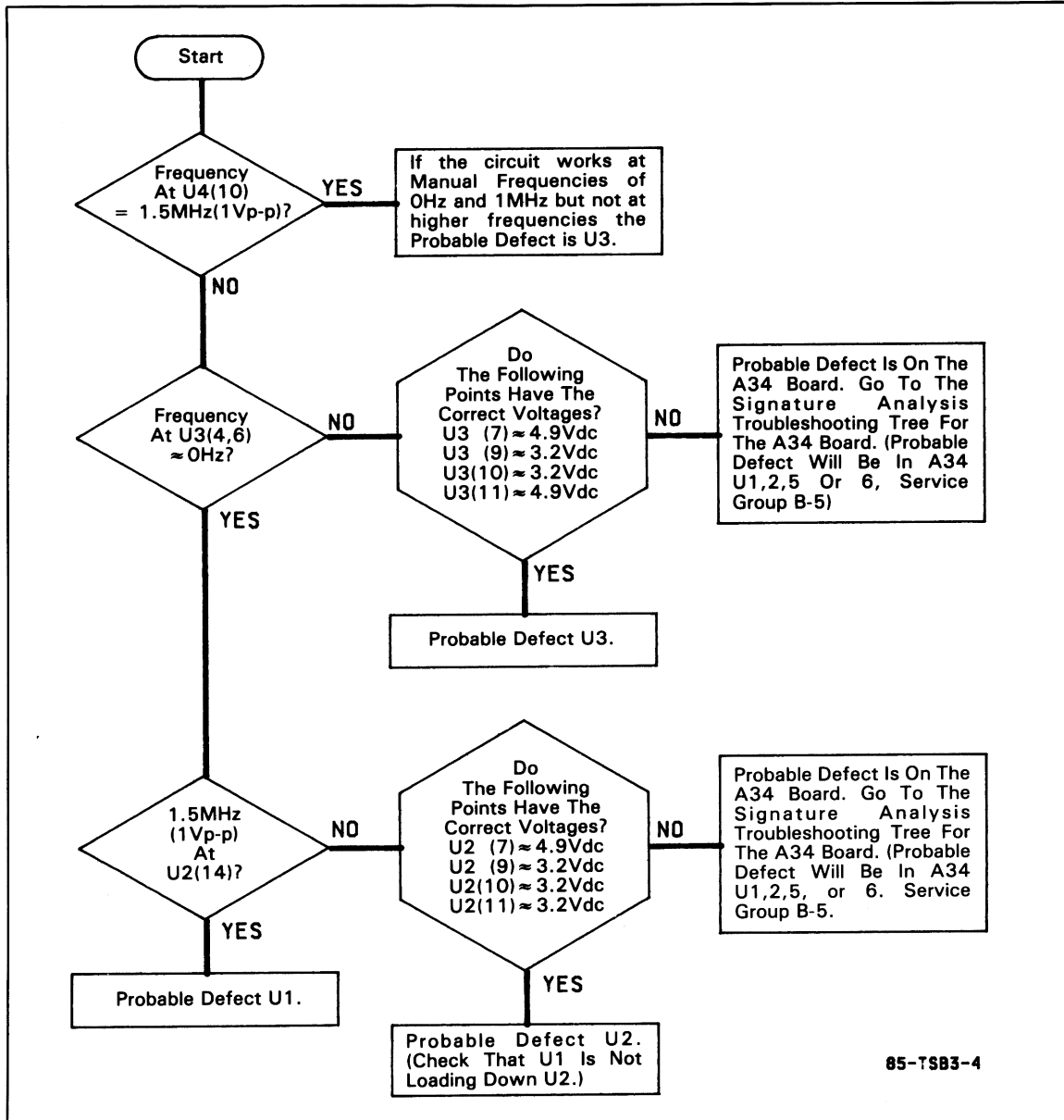
**A26 Mixer Circuitry Troubleshooting Tree.**



**A26 Reference Divider Troubleshooting Tree.**

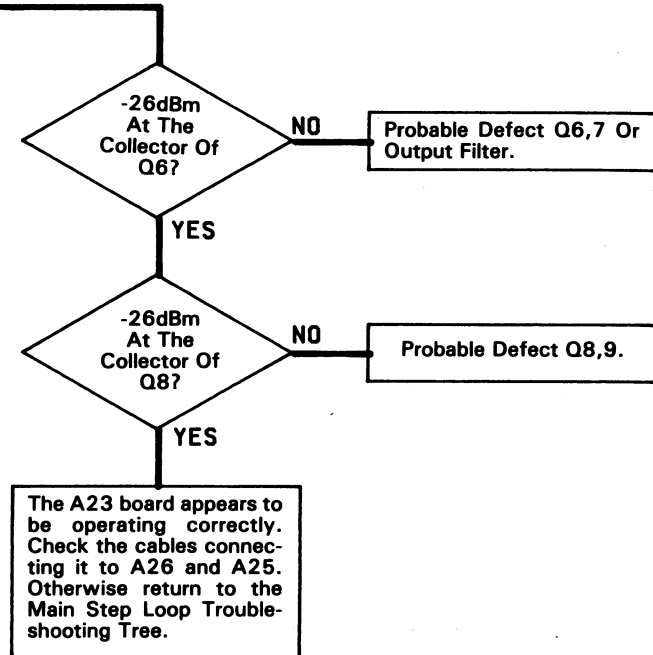
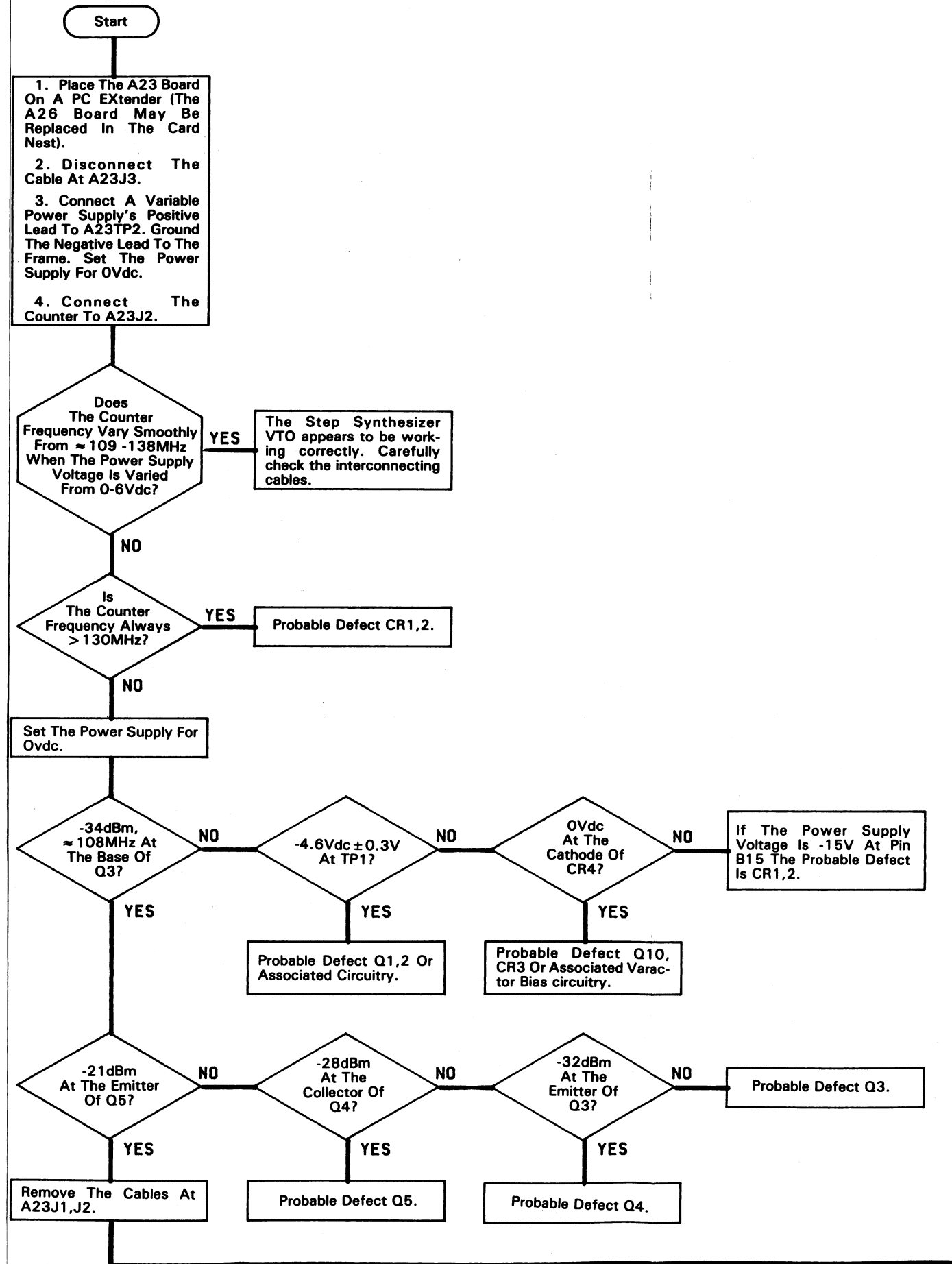
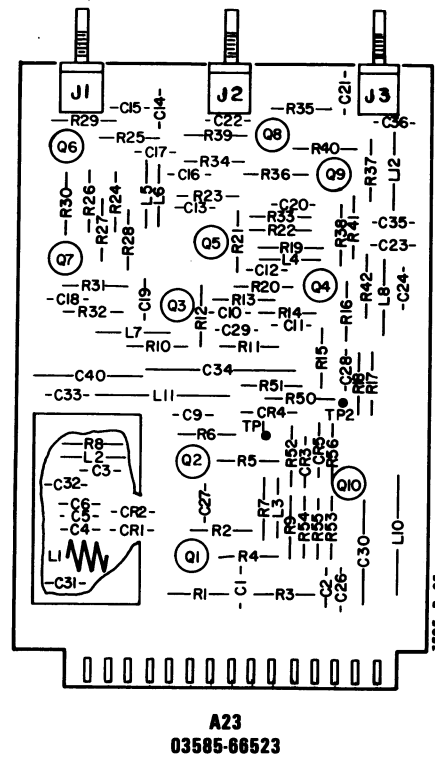


**A26  
03585-66526**



**A26 Divide-By-N Troubleshooting Tree.**

85-TS83-4



# SERVICE GROUP B-4 FRACTIONAL N SYNTHESIZER

**Board No. A31-33**

**Part No. 03585-66531 thru 03585-66533**

**INDEX:**

Title	Page
Fractional N Synthesizer (A31-33) Troubleshooting Tree .....	11-185/11-186
A31 Divide by 4 Troubleshooting Tree .....	11-187
A31 Divide by 20 Troubleshooting Tree .....	11-188
A31 VTO Control (HSLSCN) Troubleshooting Tree .....	11-189/11-190
A31 VTO Troubleshooting Tree .....	11-191/11-192
A32 Fractional N Analog Circuits Troubleshooting Tree .....	11-193/11-194
A32 Sample and Hold Troubleshooting Tree .....	11-195/11-196
A32 API Troubleshooting Tree .....	11-197/11-198
A33 Fractional N Divider Troubleshooting Tree .....	11-199/11-200
A33 Pulse Swallow Troubleshooting Tree .....	11-201/11-202
A33 Divide by 2/3 Troubleshooting Tree .....	11-203/11-204
A33 Programmable Divide by 5 Troubleshooting Tree .....	11-205/11-206

**ADJUSTMENTS:**

Component	Adjusted Parameter	Paragraph Location
A31L3	VCO Bias Voltage	5-13
A32R1	API 1	5-13
A32R2	API 2	5-13

**TROUBLESHOOTING NOTES:**

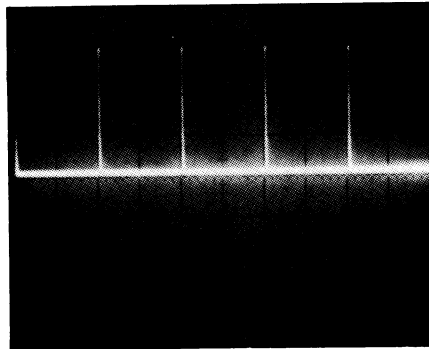
1. Throughout this Service Group you will notice questions such as:

Pulses at a 100kHz rate at U18(9)

To answer this question "yes" the oscilloscope waveform should resemble Figure 11-B-4-1, having  $\geq 1V_{p-p}$  in amplitude.

2. When asked if a particular frequency is occurring at a given pin, use the counter with a 1:1 oscilloscope probe.

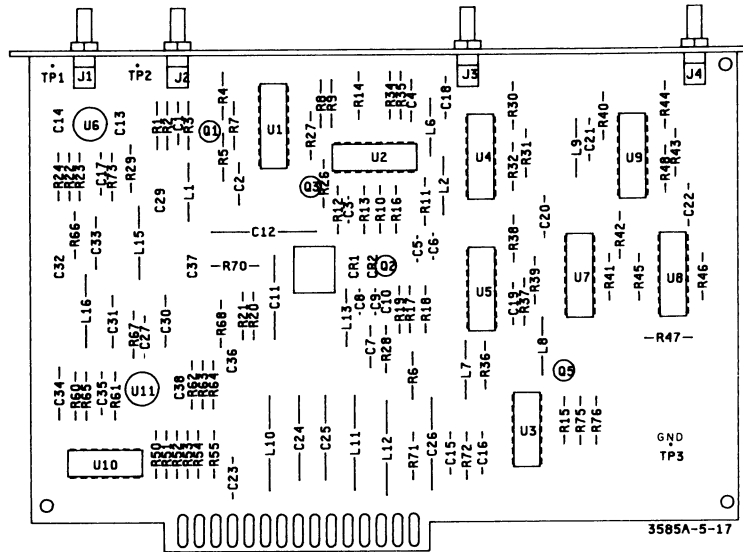




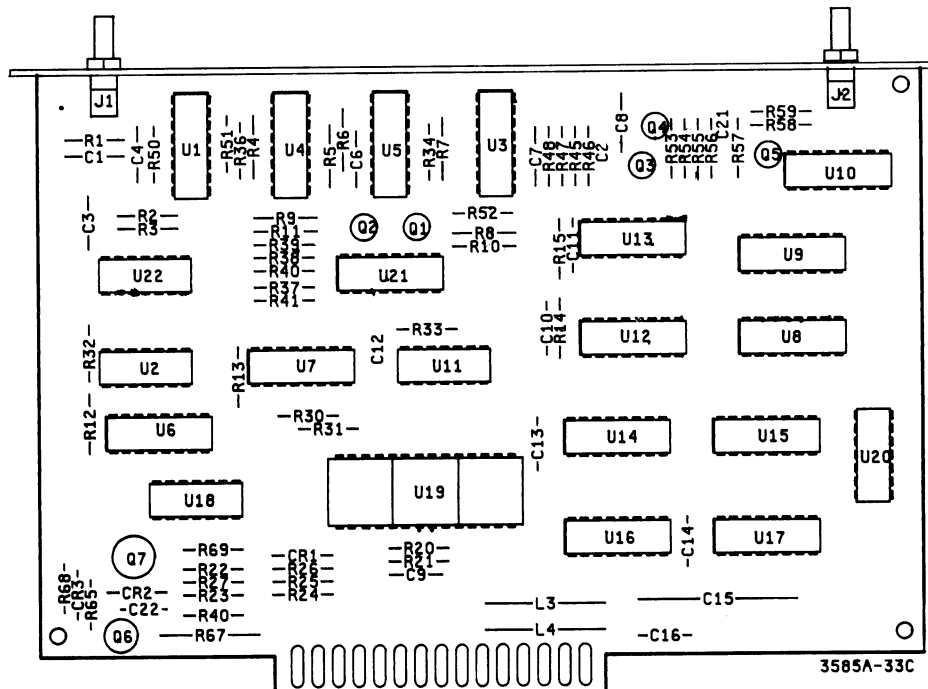
0.5 volts/DIV

5  $\mu$ sec/DIV

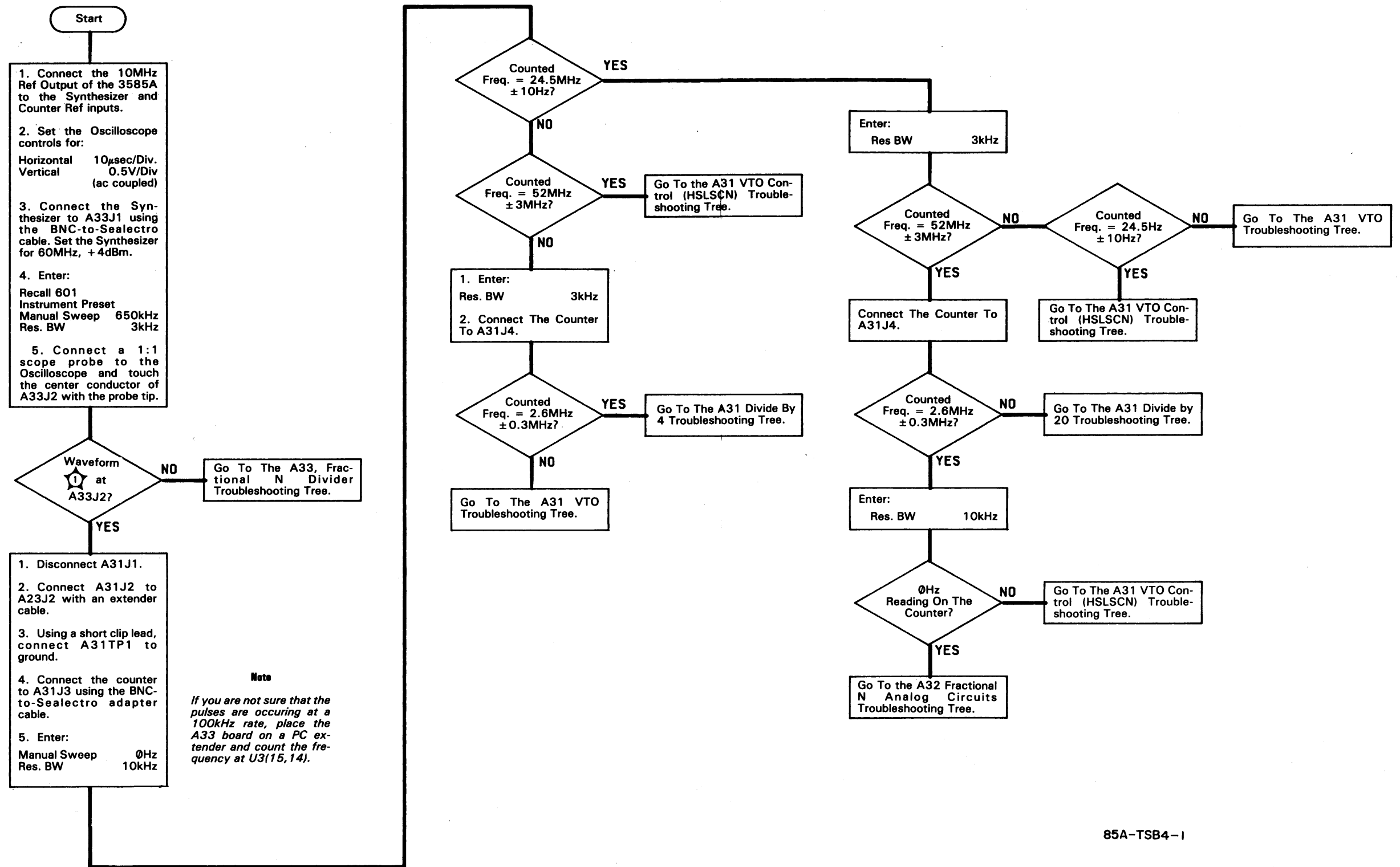
Figure 11-B-4-1



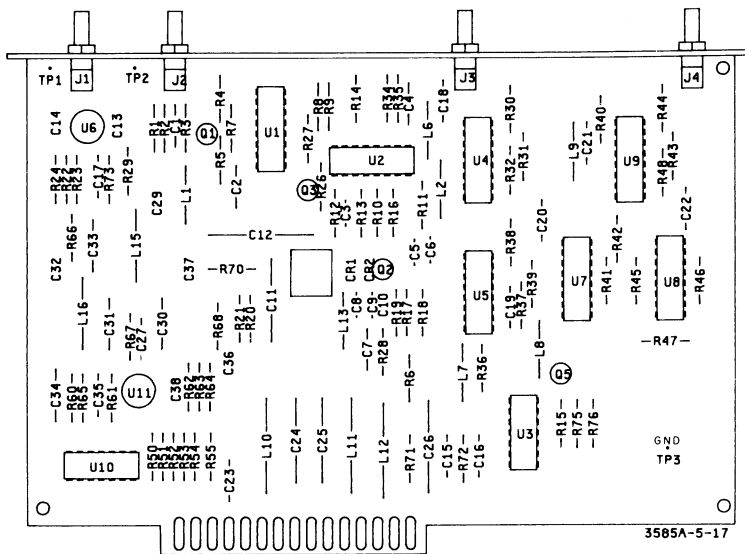
A31  
03585-66531



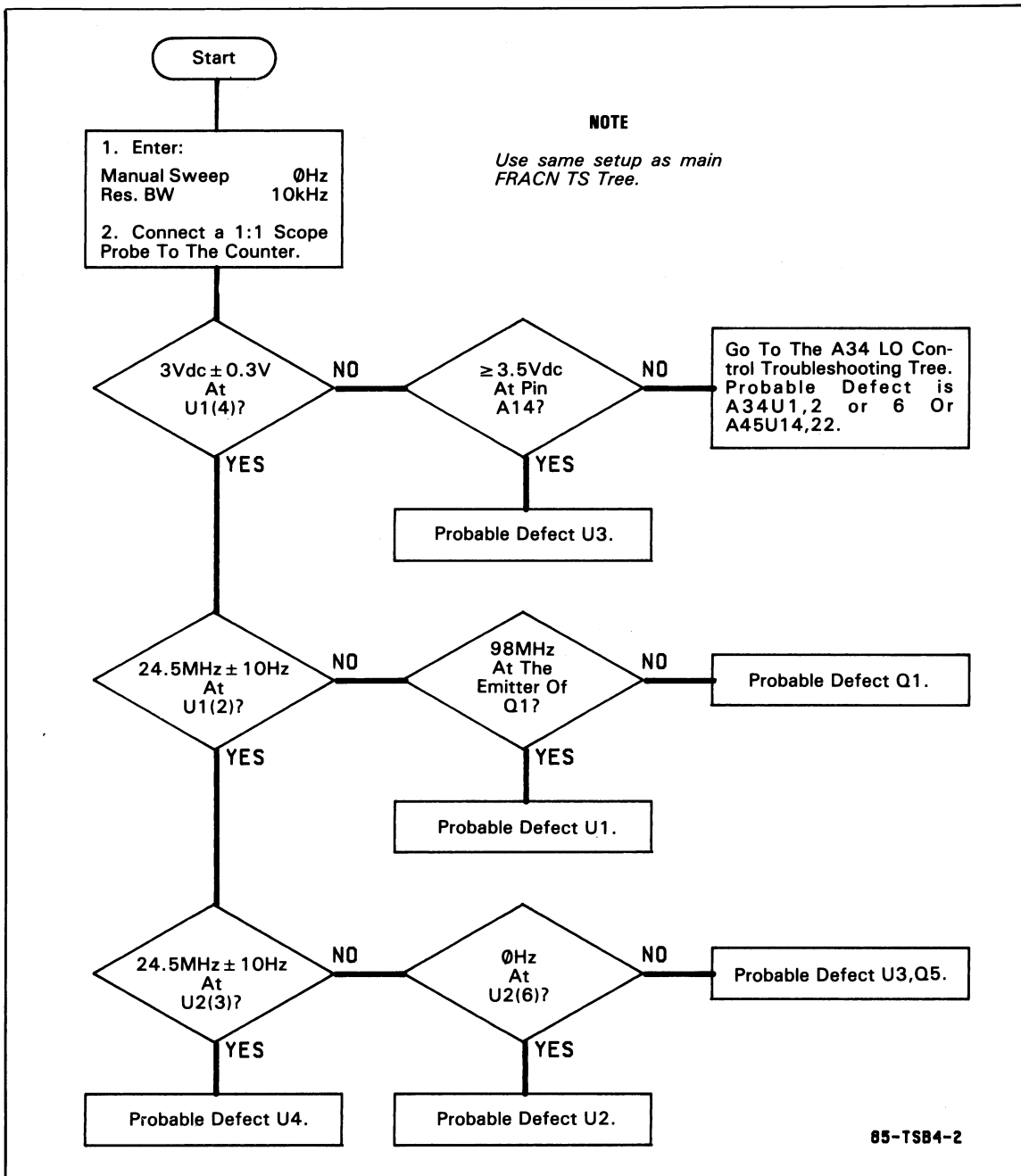
A33  
03585-66533



85A-TSB4-1

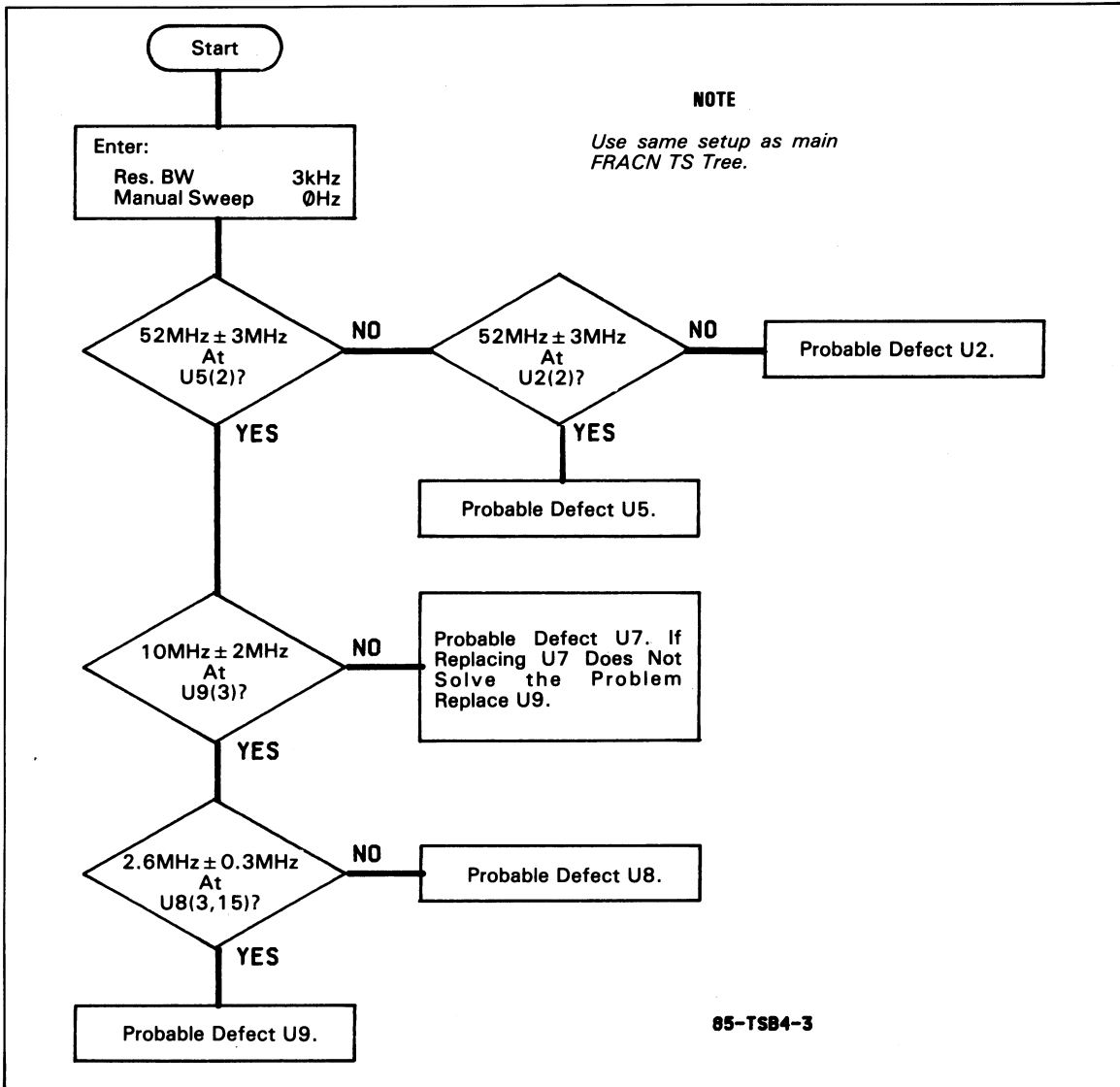


A31  
03585-66531

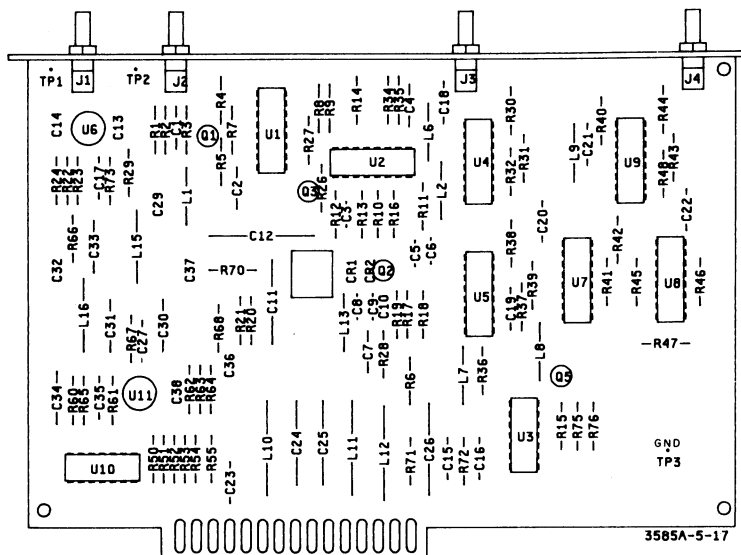


**A31 Divide By 4 Troubleshooting Tree.**

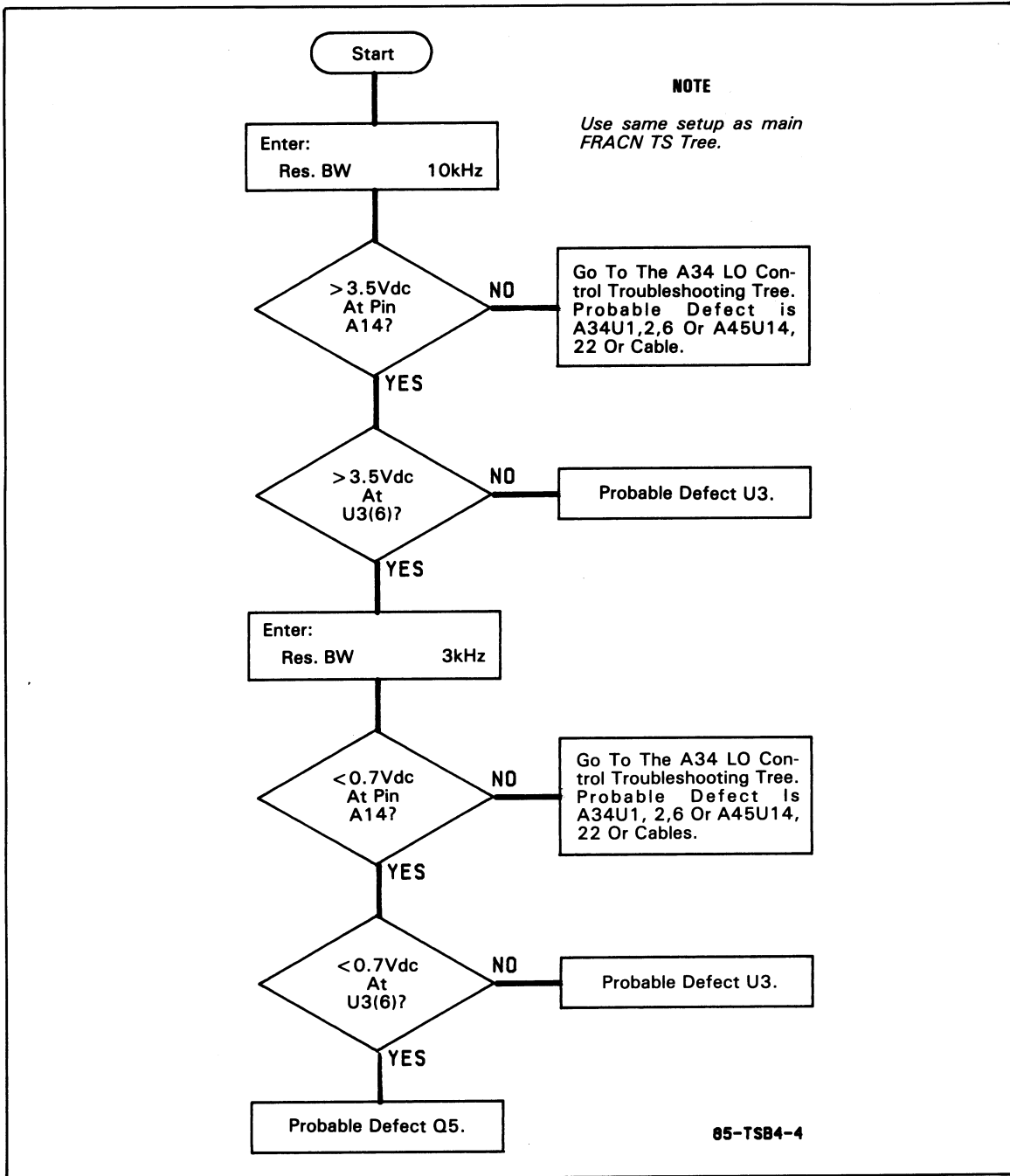
85-TSB4-2



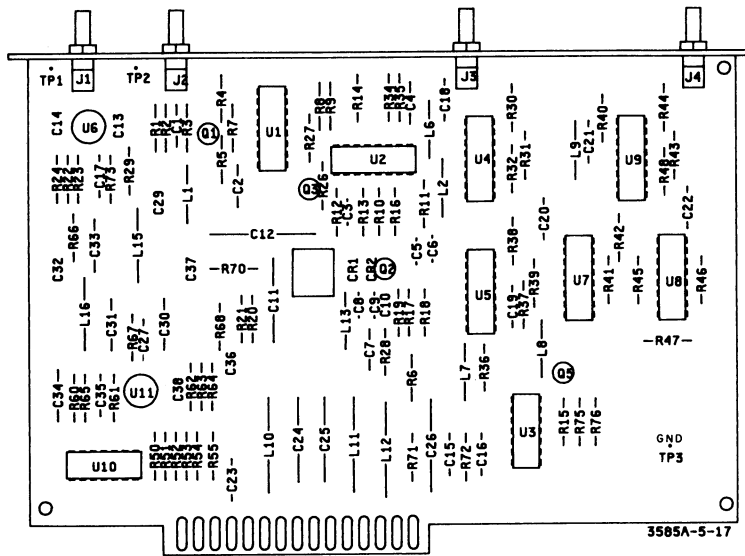
**A31 Divide By 20 Troubleshooting Tree.**



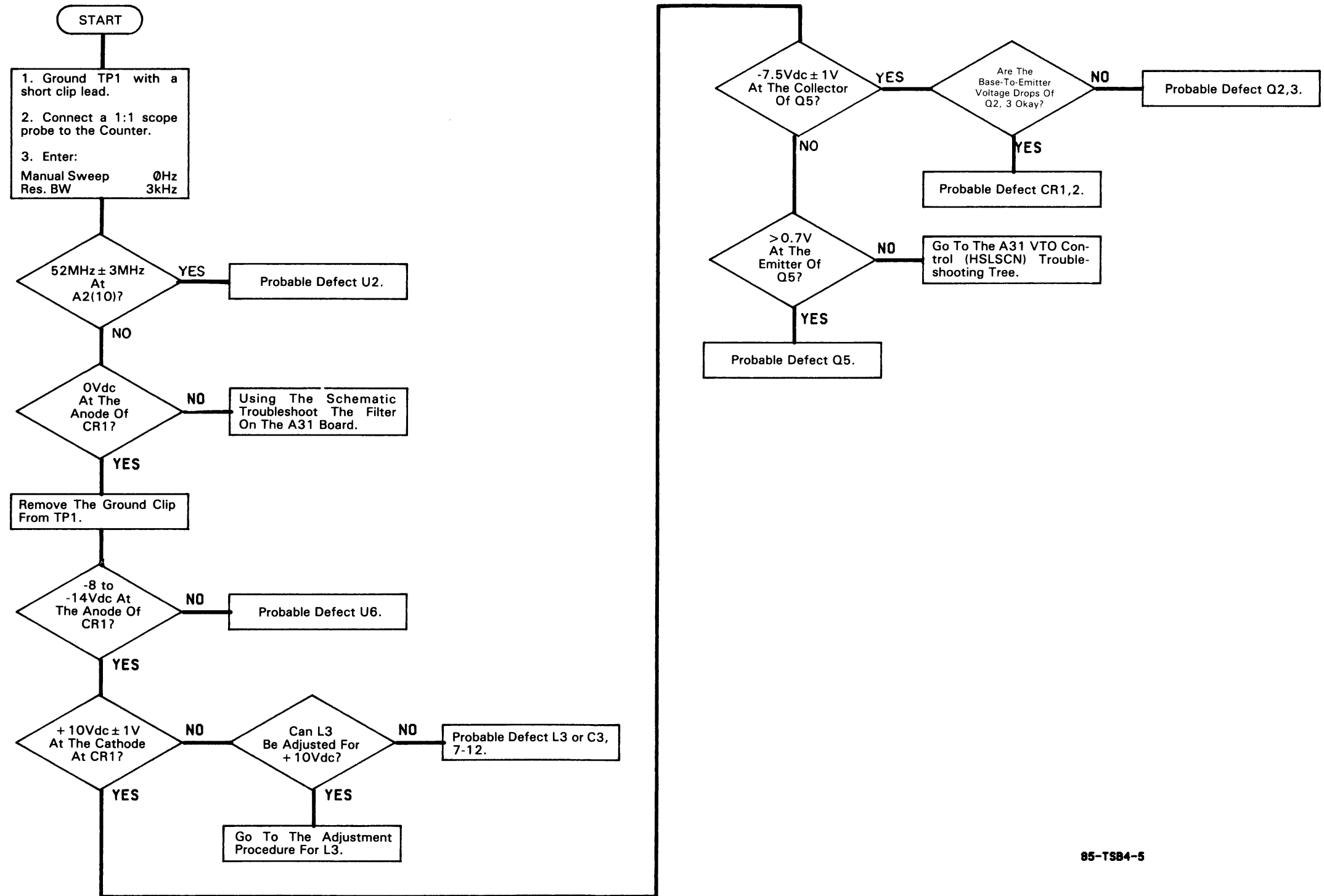
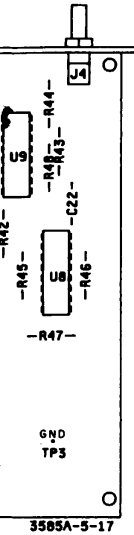
**A31**  
**03585-66531**



**A31 Divide By 4 Troubleshooting Tree**



A31  
03585-68531

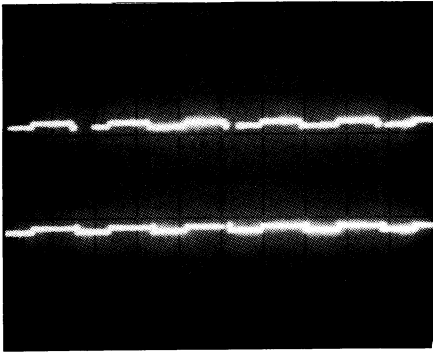


85-TSB4-5



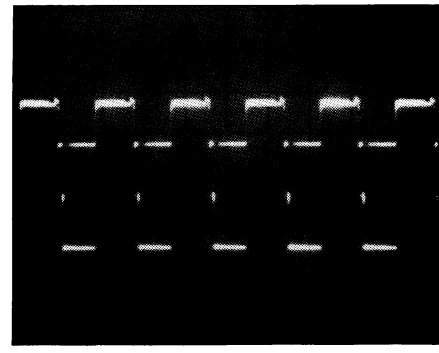
Negative Trigger

1



1 volts/DIV

2

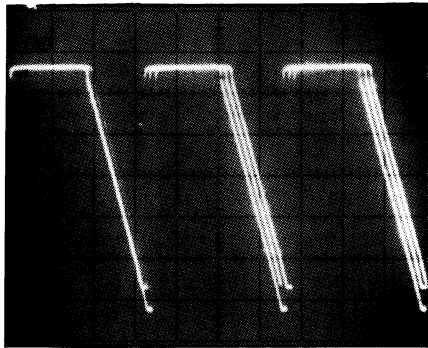


1 volts/DIV

5  $\mu$ sec/DIV  
ac Coupled

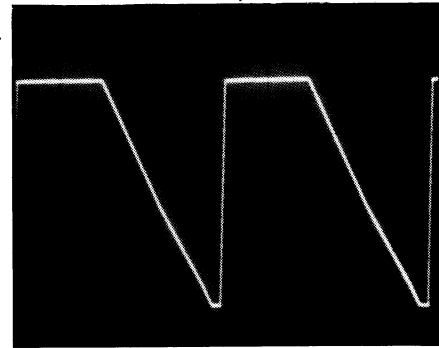
5  $\mu$ sec/DIV  
dc Coupled

3



1 volts/DIV

4

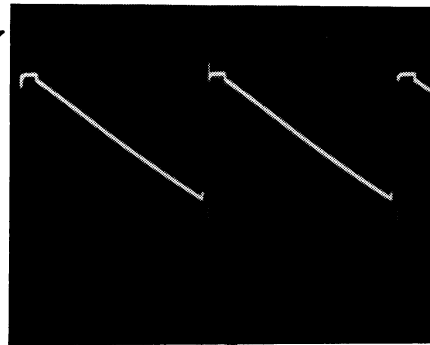


2 volts/DIV

2  $\mu$ sec/DIV

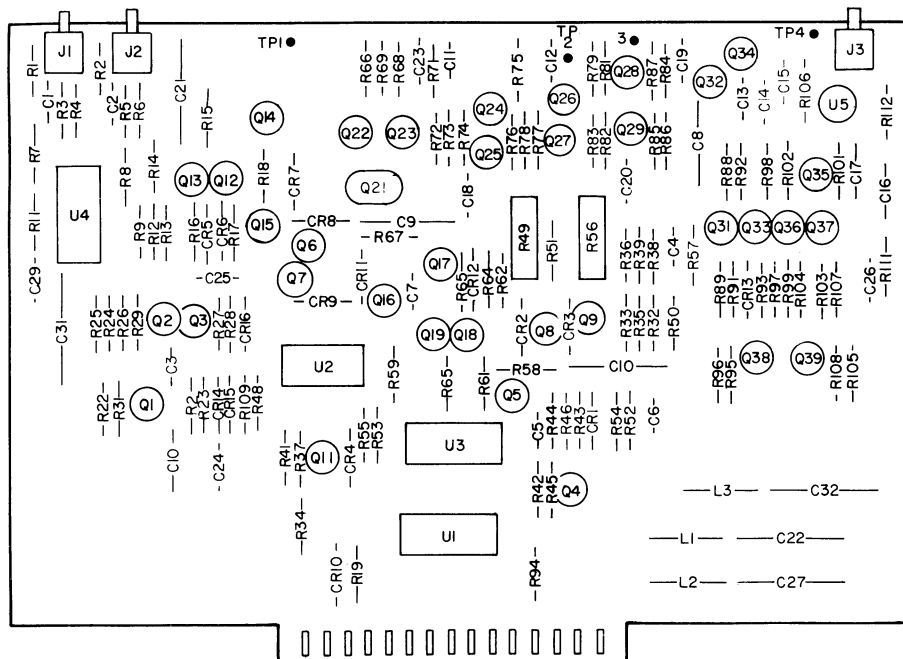
2  $\mu$ sec/DIV

5

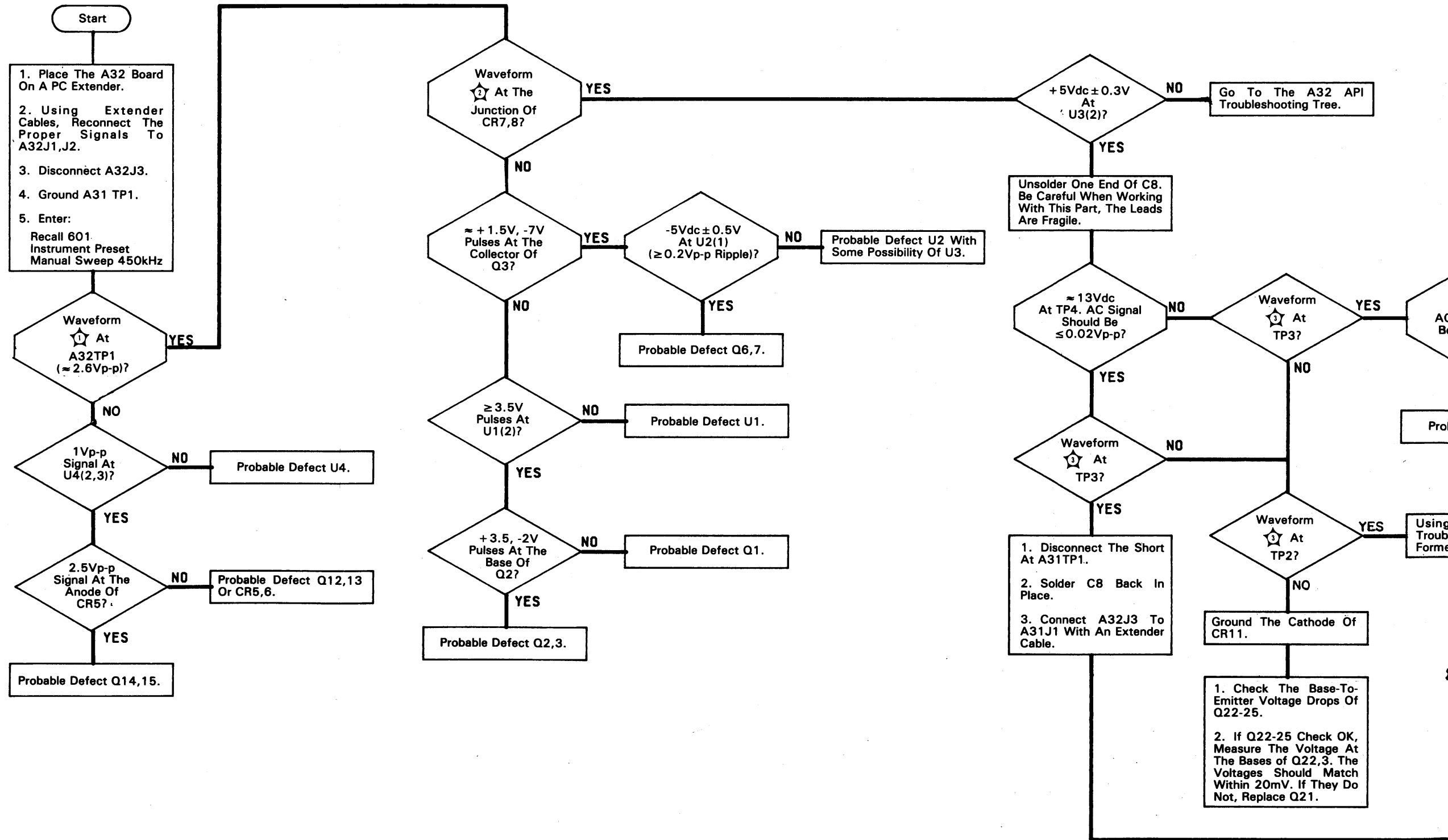


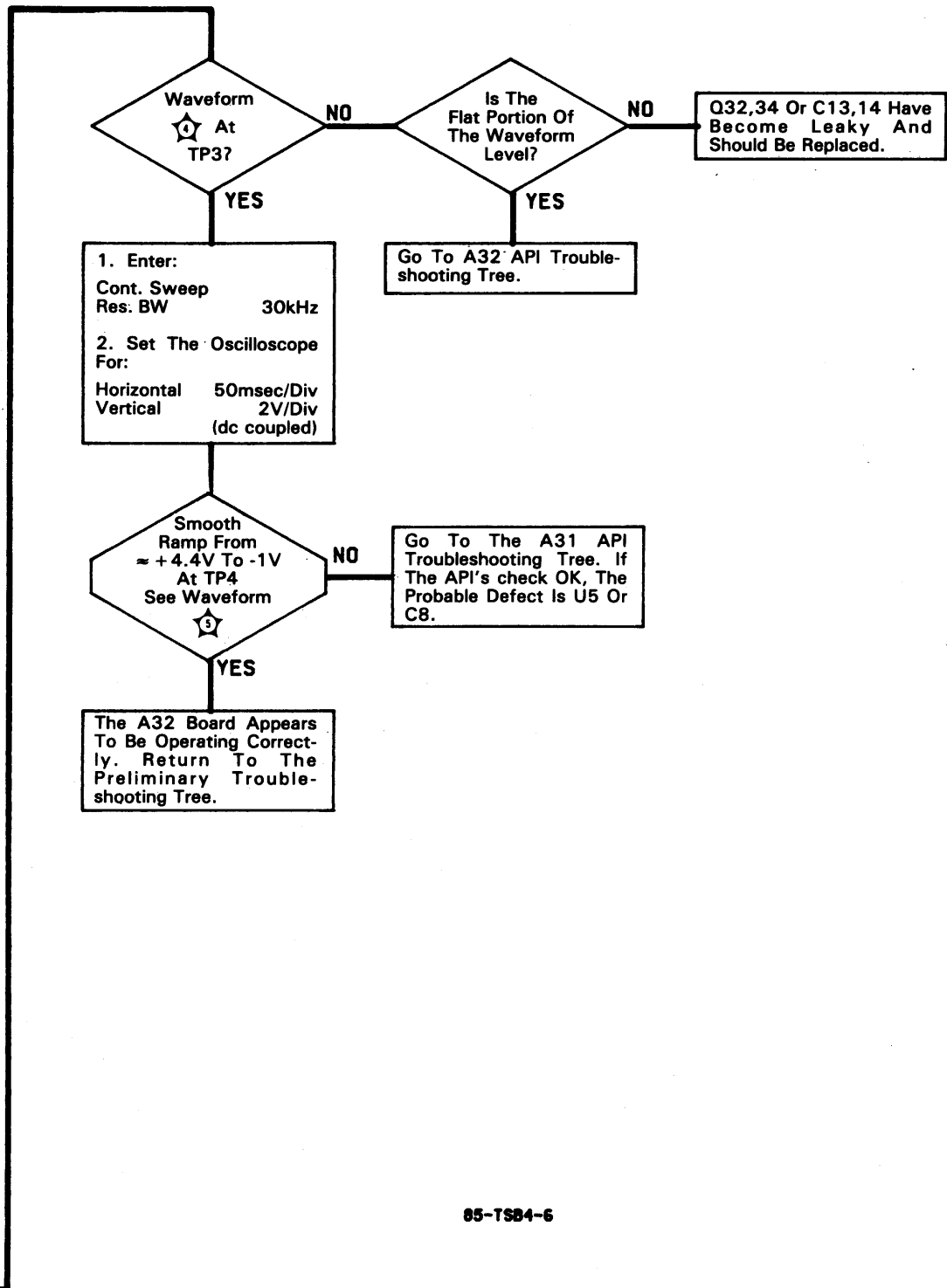
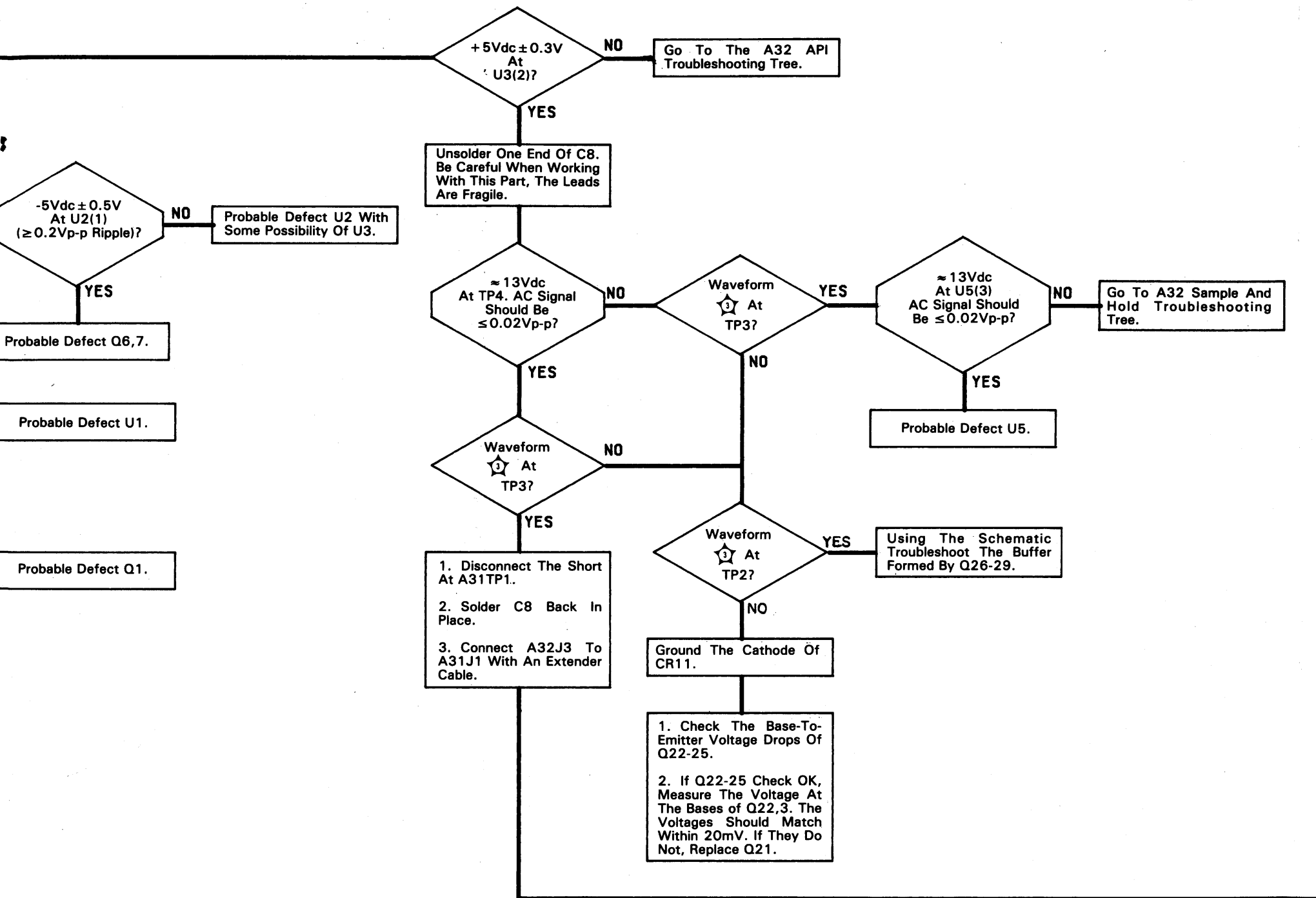
2 volts/DIV

50 msec/DIV

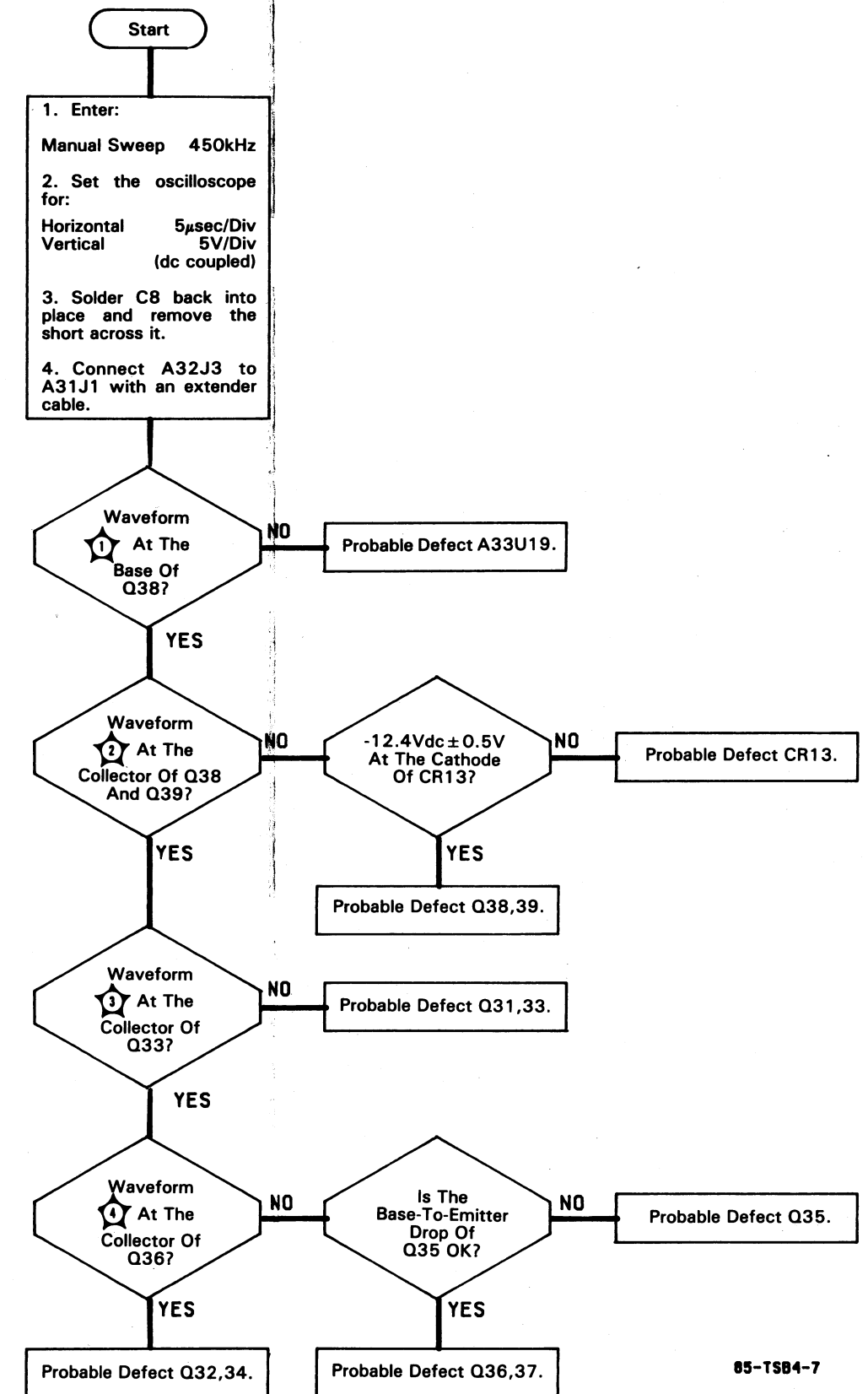
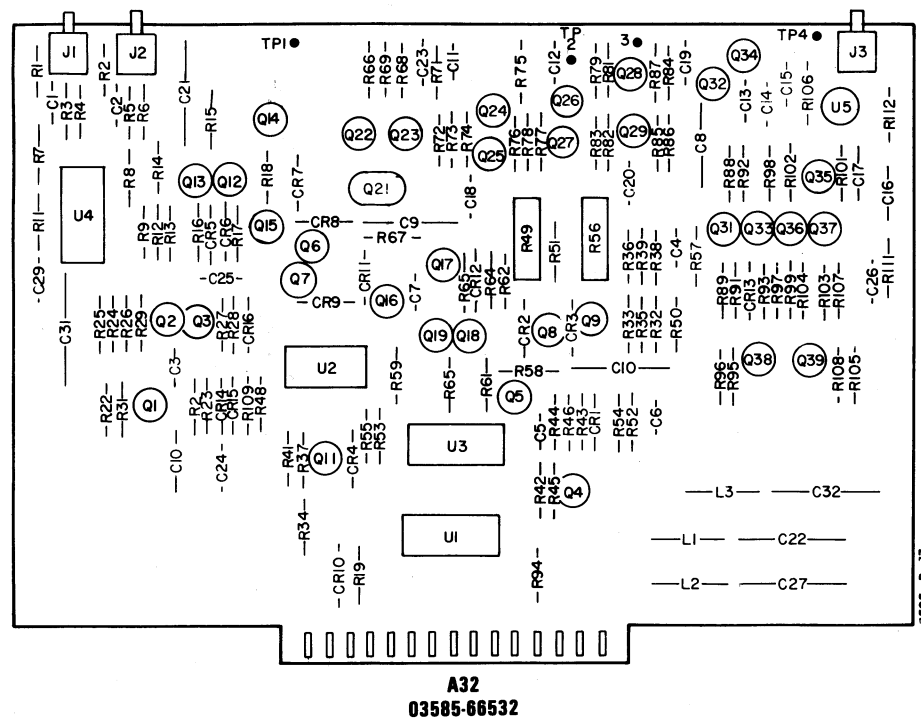
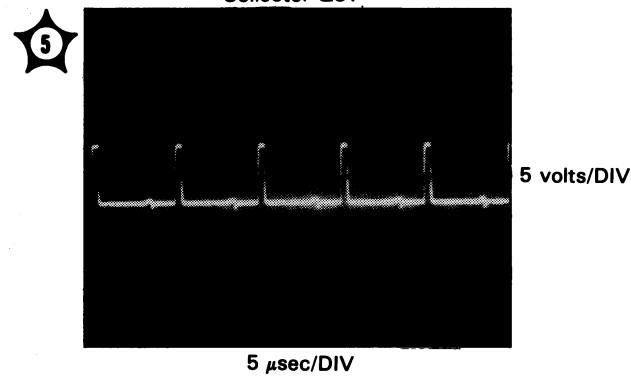
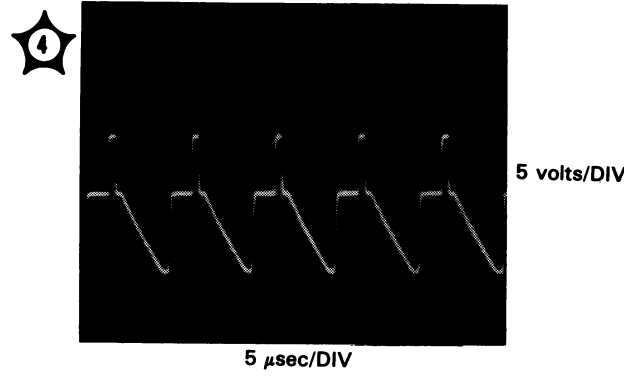
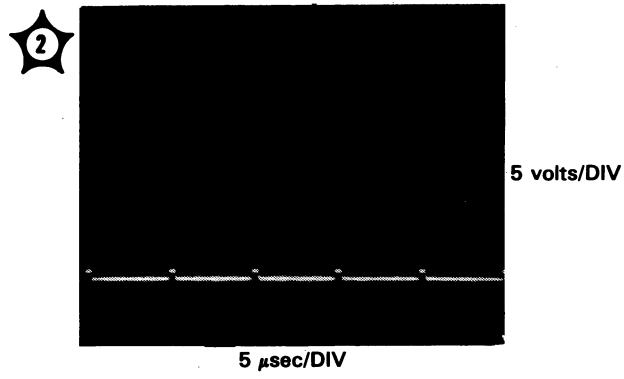
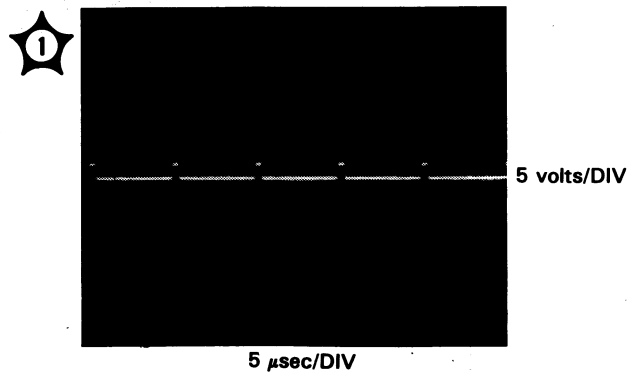


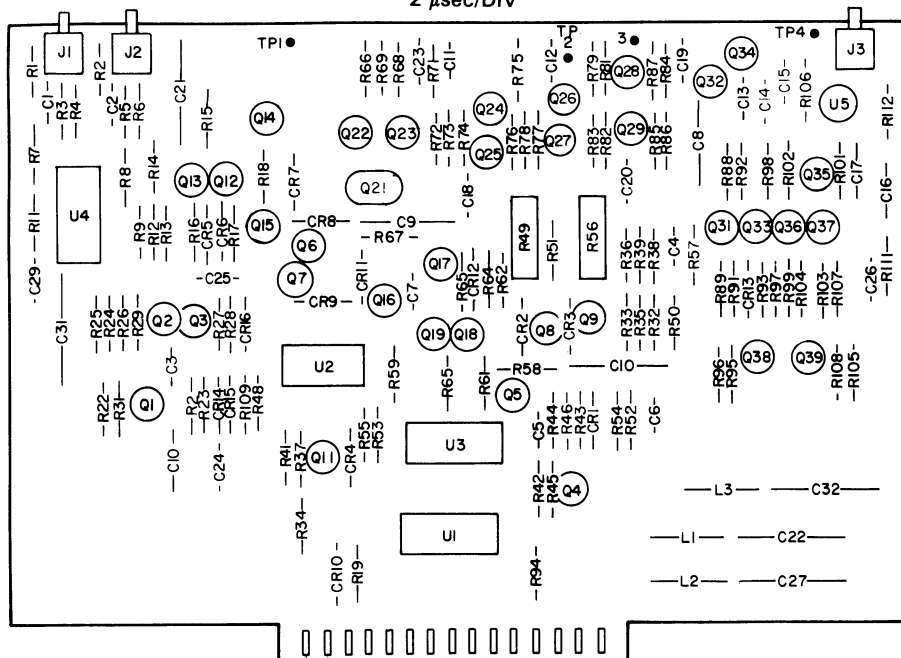
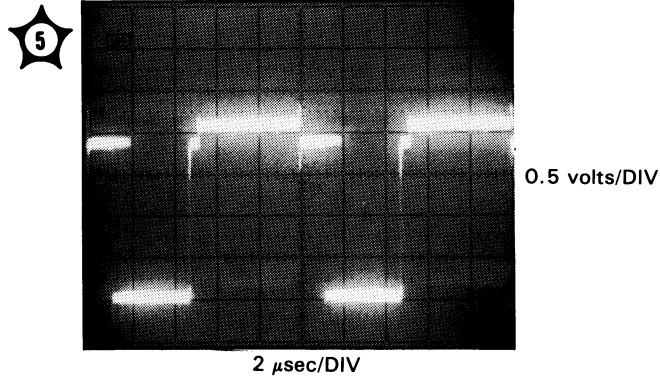
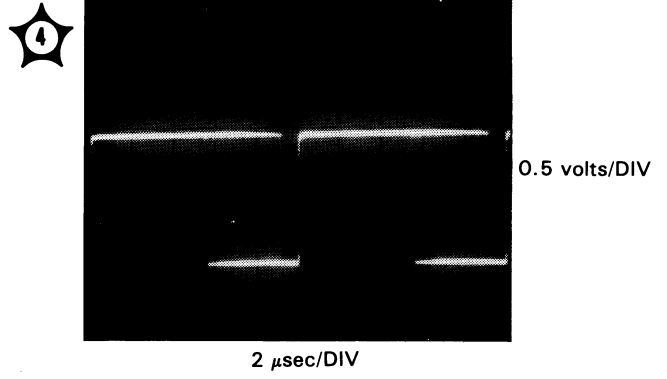
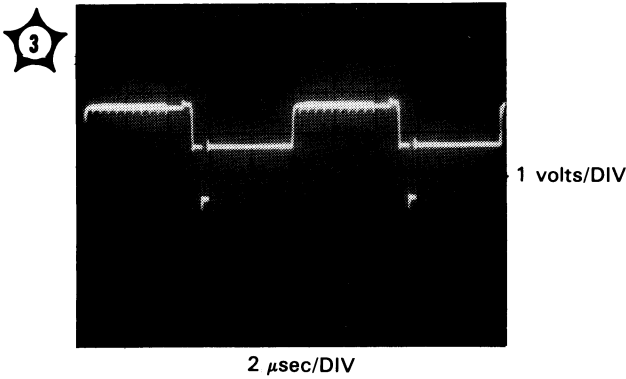
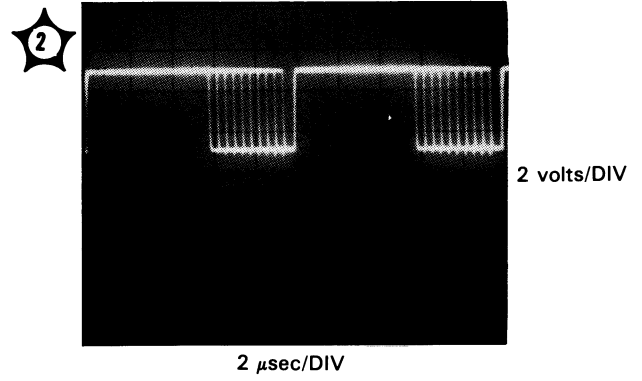
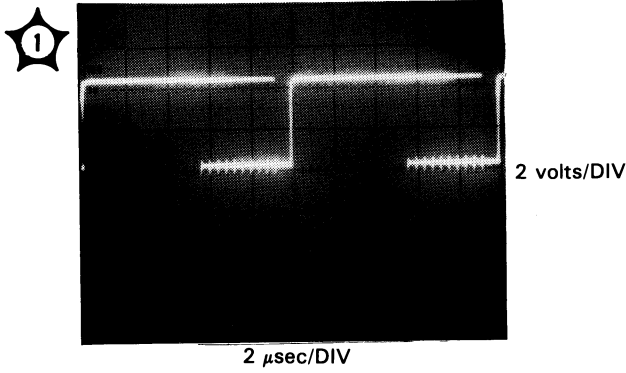
A32  
03585-66532



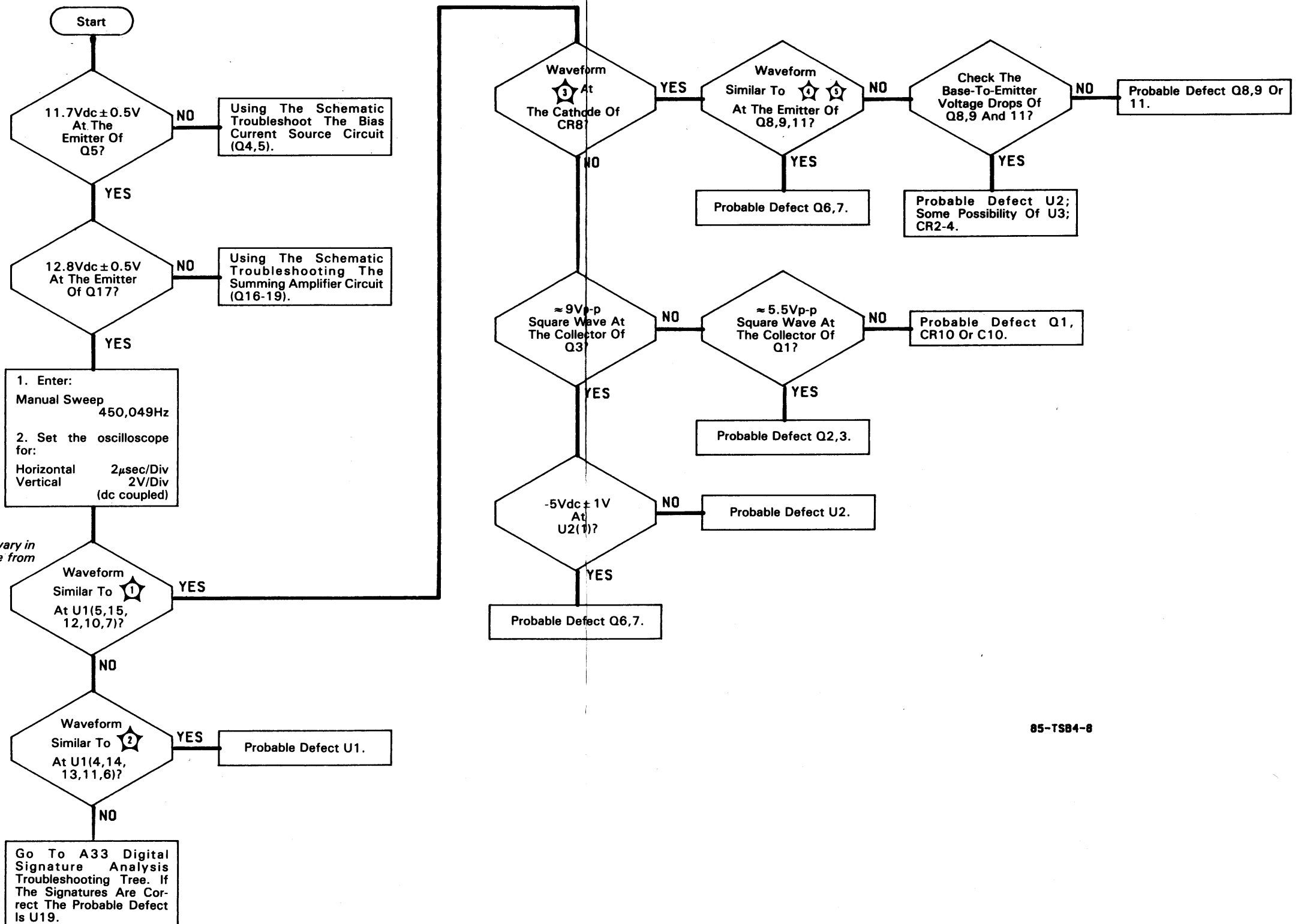


85-TSB4-6

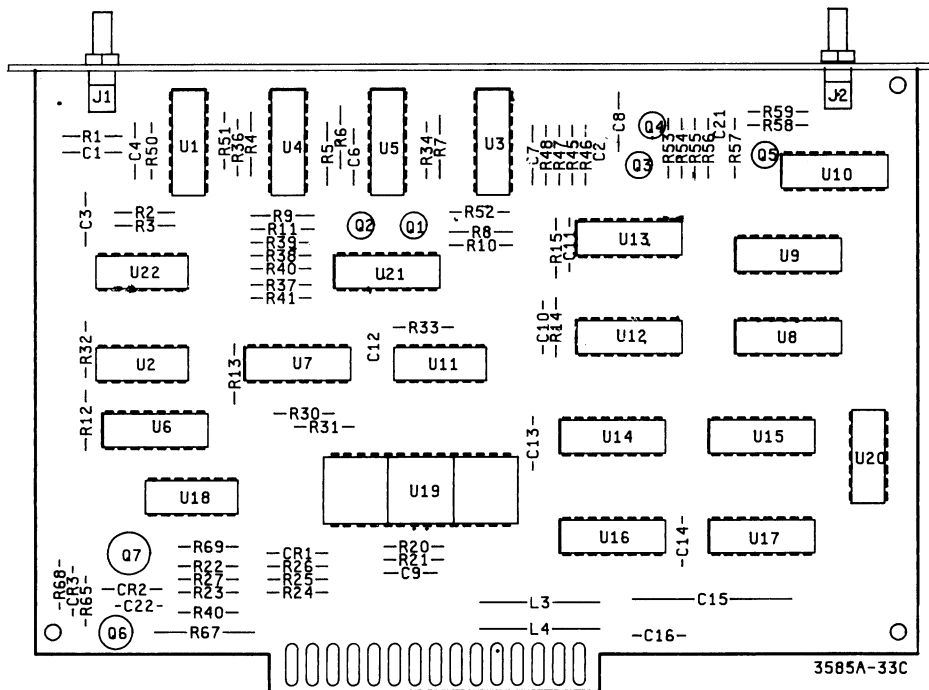




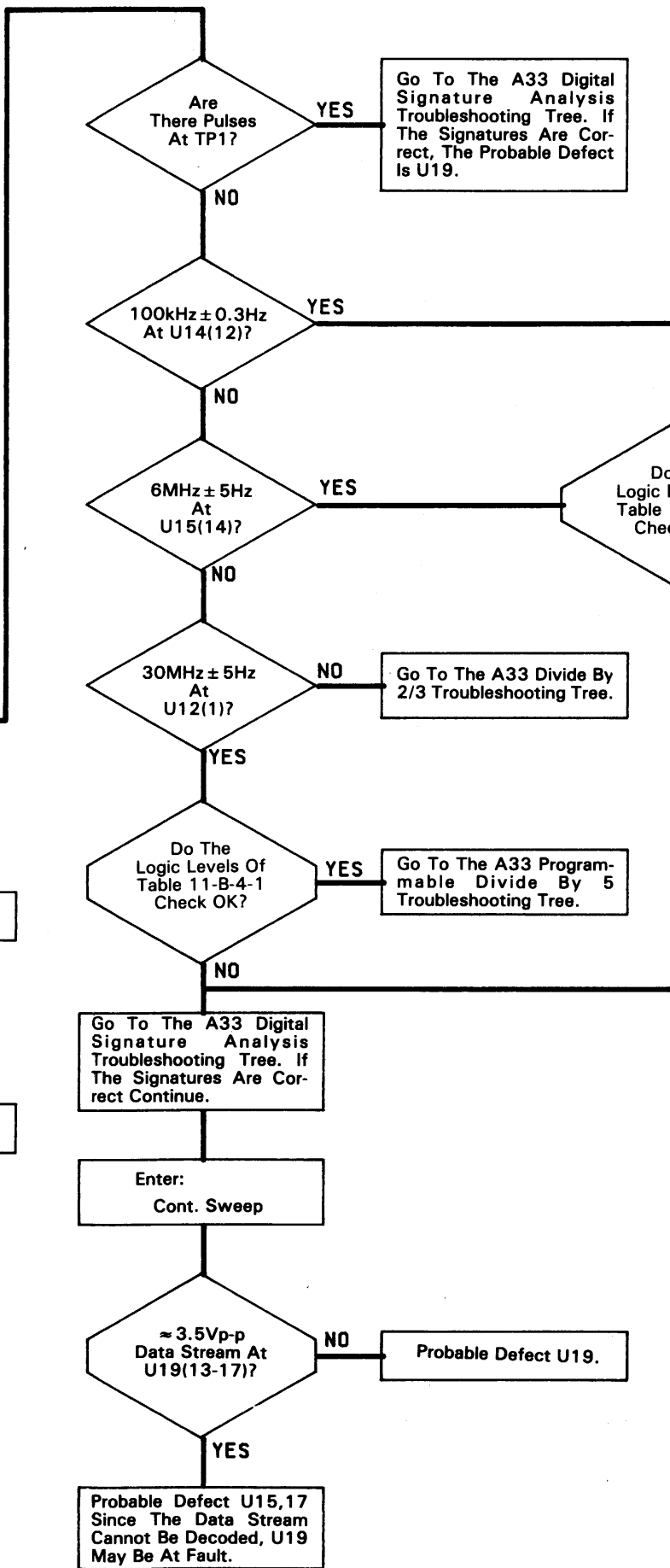
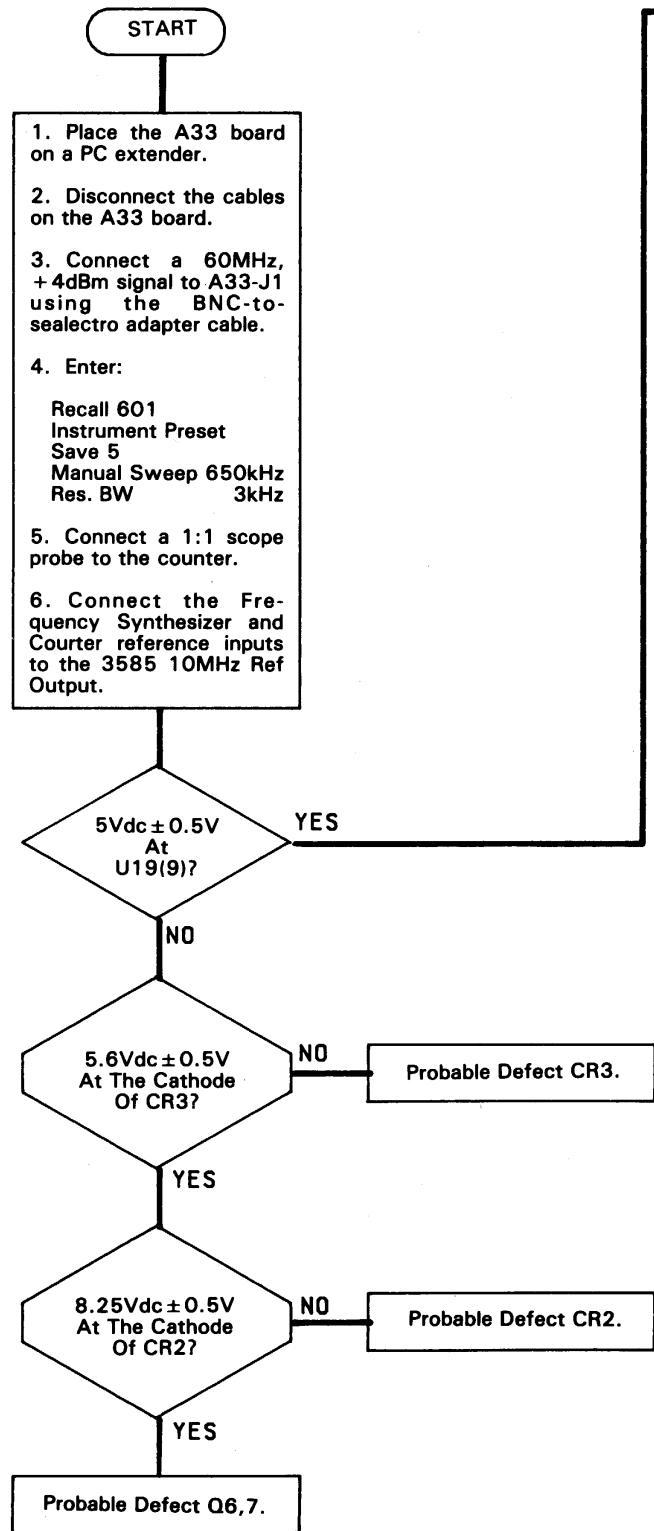
A32  
03585-66532



85-TSB4-8

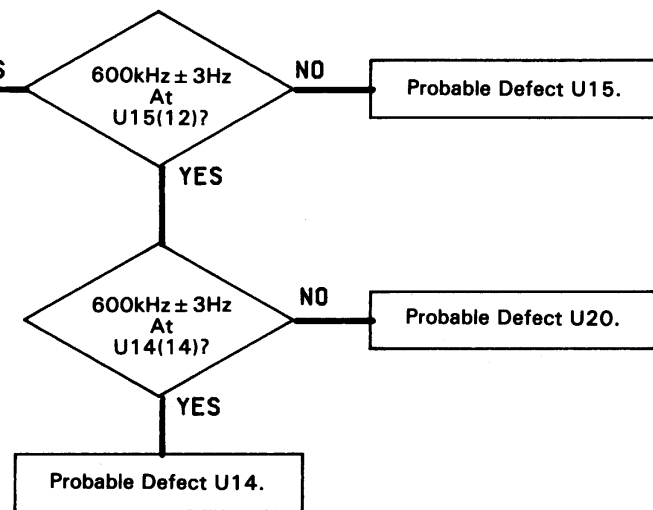


A33  
03585-66533



**Table 11-B-4-1**  
H ≥ 3.5V ; L ≤ 0.8V

U14(15)	H	U8(5)	L
(1)	H	(11)	L
(10)	L	(8)	H
U15(15)	H	U17(5)	H
(1)	L		
(10)	L		
(9)	H		

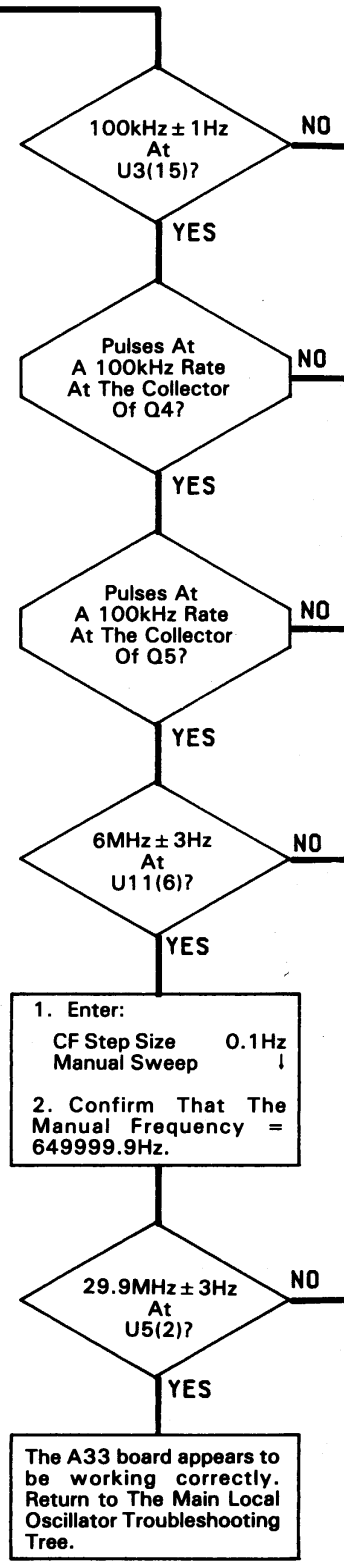


**NOTE**

The A33 board is basically one large divider circuit. Due to the nature of Fractional N there are many feedback loops. This compounds the problem of troubleshooting this board. If you think that one of the sections is dividing correctly, but the frequencies do not match those listed, try using the following guide.

- With the listed set-up:
- from A33J1 to U5(2,3) = +2
  - from U5(2) to U13(6) = +5
  - from U5(2) to U6(6,7) = +5
  - from U15(14) to U15(12) = +10
  - from U14(14) to U14(13) = +6

If all of the frequencies except U5(2,3) are incorrect, check to see if U19(7) (the chip clock) and U19(28) (the cycle start) are pulsing. If the chip clock and cycle start are not pulsing, trace their signal paths backwards to locate the failure.





3 Digital analysis Tree. If Are Core Defect

Table 11-B-4-1  
 $H \geq 3.5V$  ;  $L \leq 0.8V$

U14(15) H	U8(5) L
(1) H	(11) L
(10) L	(8) H
U15(15) H	U17(5) H
(1) L	
(10) L	
(9) H	

Divide By ing Tree.

Program- By 5 Tree.

t U19.

Do The Logic Levels Of Table 11-B-4-1 Check OK?

600kHz ± 3Hz At U15(12)?

600kHz ± 3Hz At U14(14)?

Probable Defect U14.

Probable Defect U15.

Probable Defect U20.

NOTE

The A33 board is basically one large divider circuit. Due to the nature of Fractional N there are many feedback loops. This compounds the problem of troubleshooting this board. If you think that one of the sections is dividing correctly, but the frequencies do not match those listed, try using the following guide.

With the listed set-up:

- from A33J1 to U5(2,3) = +2
- from U5(2) to U13(6) = +5
- from U5(2) to U6(6,7) = +5
- from U15(14) to U15(12) = +10
- from U14(14) to U14(13) = +6

If all of the frequencies except U5(2,3) are incorrect, check to see if U19(7) (the chip clock) and U19(28) (the cycle start) are pulsing. If the chip clock and cycle start are not pulsing, trace their signal paths backwards to locate the failure.

100kHz ± 1Hz At U3(15)?

Pulses At A 100kHz Rate At The Collector Of Q4?

Pulses At A 100kHz Rate At The Collector Of Q5?

6MHz ± 3Hz At U11(6)?

1. Enter: CF Step Size 0.1Hz Manual Sweep  
 2. Confirm That The Manual Frequency = 649999.9Hz.

29.9MHz ± 3Hz At U5(2)?

The A33 board appears to be working correctly. Return to The Main Local Oscillator Troubleshooting Tree.

NO

YES

NO

YES

NO

YES

NO

YES

NO

YES

Probable Defect Q3,4.

Probable Defect Q5.

Probable Defect U6,7.

Probable Defect U11.

Go To The A33 Pulse Swallow Troubleshooting Tree.

Pulses At A 100kHz Rate At U18(9)?

100kHz ± 1Hz At U2(8)?

30MHz ± 5Hz At U3(11)?

Probable Defect U3.

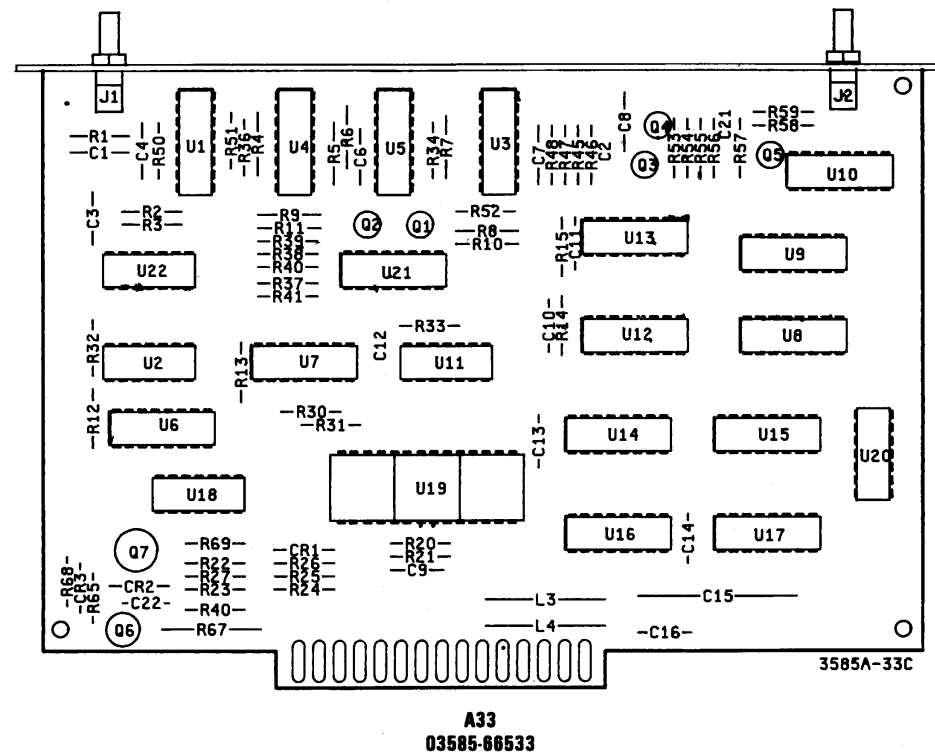
Pulses At A 100kHz Rate At U18(8)?

6MHz ± 5Hz At U2(11)?

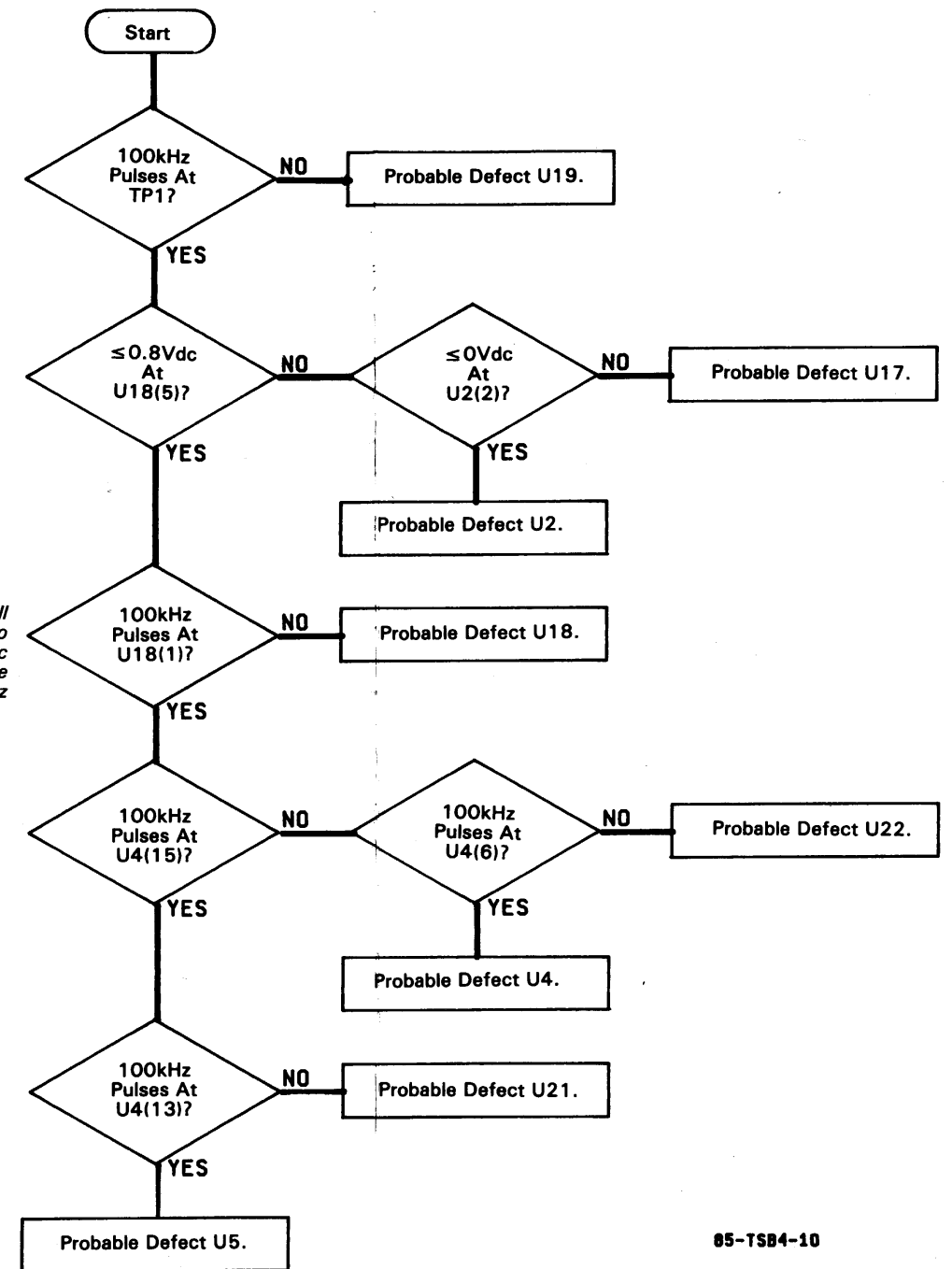
Probable Defect U1.

Probable Defect U3.

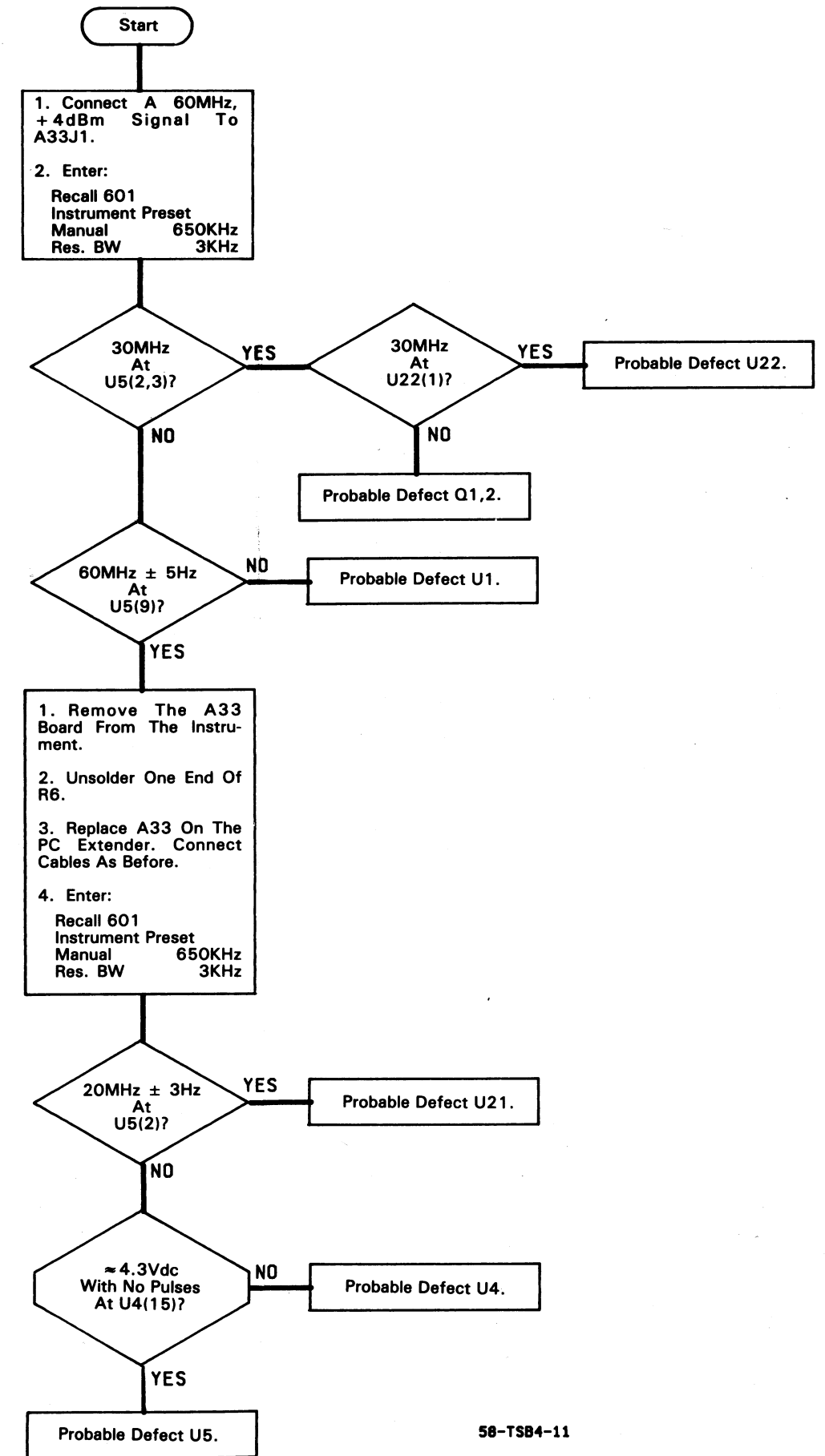
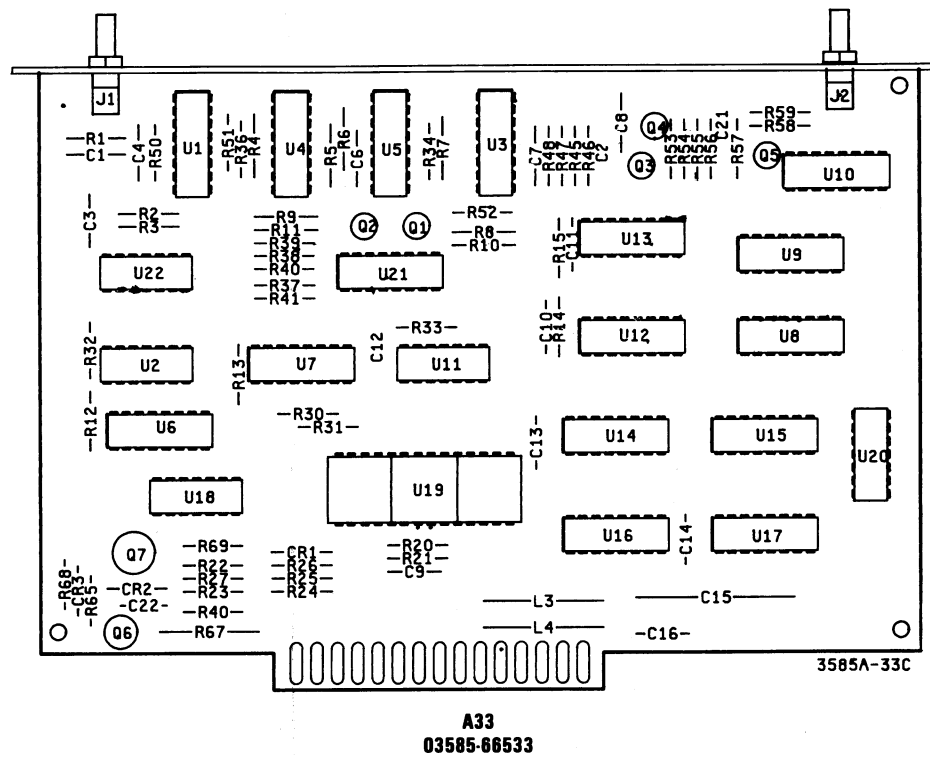
Probable Defect U19.



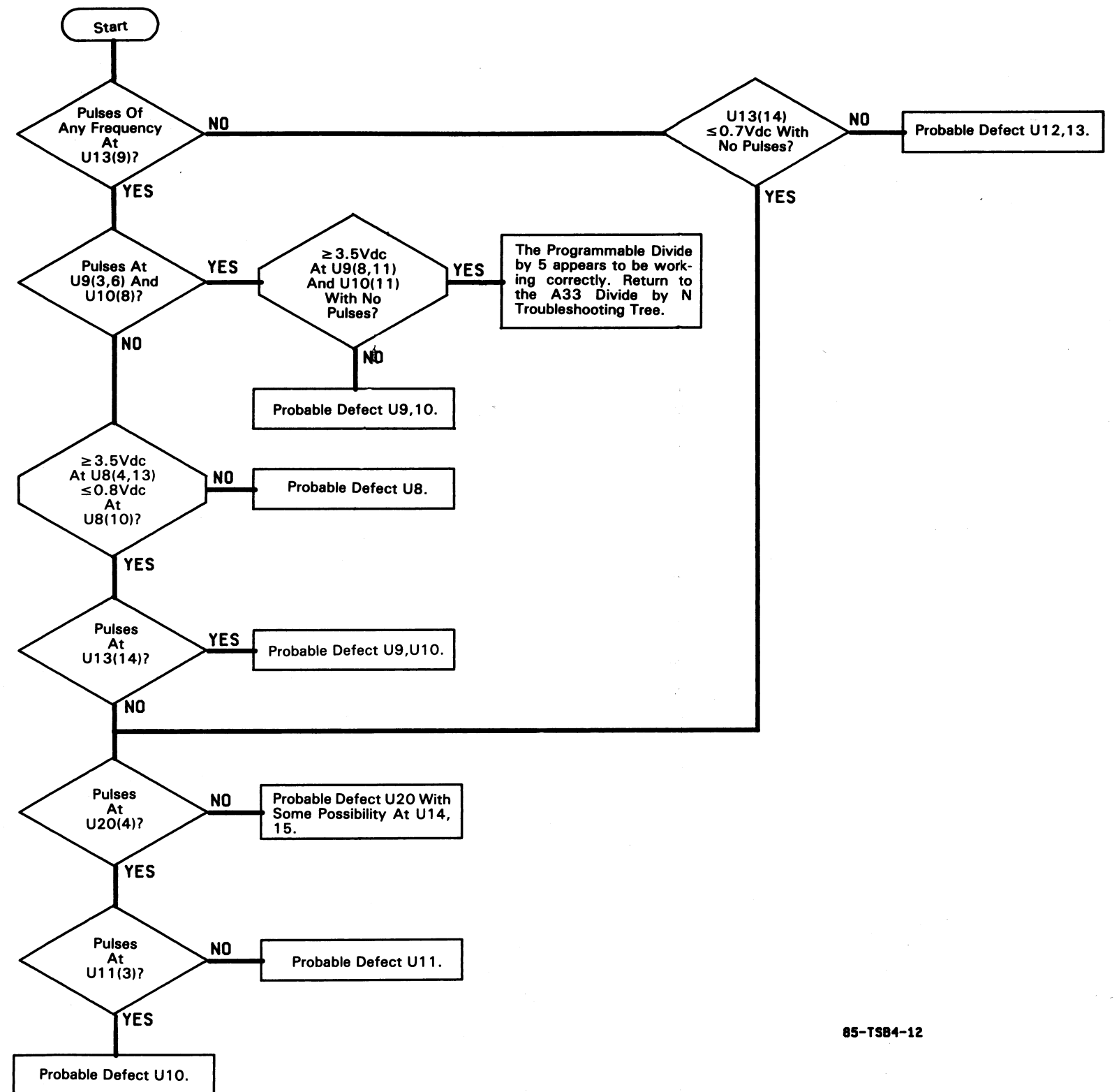
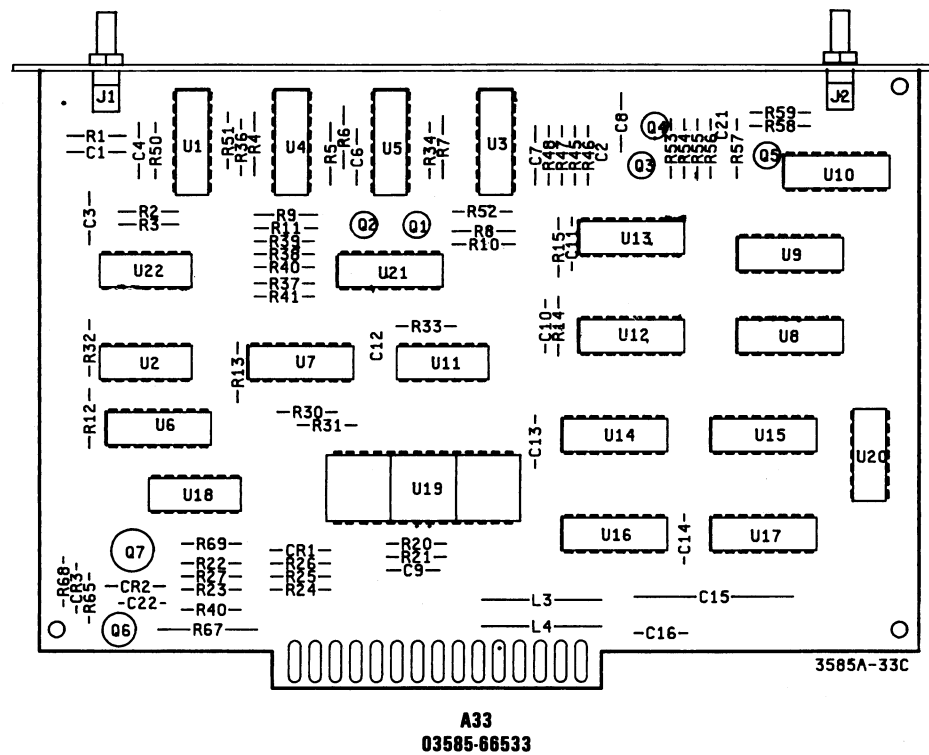
**NOTE**  
Careful observation will show that there are two pulses occurring 0.6µsec apart. Use an oscilloscope to check the 100kHz pulses.



85-TSB4-10



58-TSB4-11



85-TS84-12

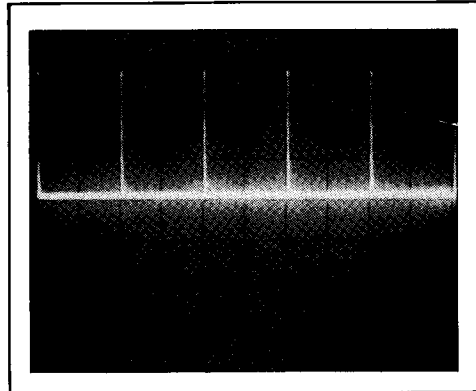


Figure 11-B-4-2. Example Pulse Waveform




**A33 Board Signature Analysis Tests.**

Equipment Required: Signature Analyzer (-hp- Model 5004A).

- a. Turn the instrument off.
- b. On the A45 board (tabs = Yellow/Green), set DIP test switches 2, 3 and 6 to the “on” (inboard) position. Verify that all other A45 test switches are in the “OPEN” (outboard) position.
- c. Connect the Signature Analyzer as follows:

START and STOP-----A45 TP1  
 CLOCK-----A45 TP2  
 GND-----A45 “GND” Test Point

- d. Set the Signature Analyzer controls as follows:

START ----- (out)   
 STOP----- (in)   
 CLOCK----- (out)   
 HOLD----- off (out)  
 SELF TEST----- off (out)

- e. Turn the 3585A (and Signature Analyzer) on.
- f. At this point, the CRT screen should be blank, the front-panel LED indicators should be flashing and the red LED on the A45 board should be flashing.

To verify that your test setup is correct and the test routine is running properly, touch the Signature Analysis test probe to A33, pin A11

The signature should be “C2HH”.

g. Check for the following signatures at A33, pins B3 thru B8:

<b>A33 Pin</b>	<b>Signature</b>
B3	810F
B4	Unstable
B5	U36C
B6	A030
B7	P6PU
B8	55P4

1. If the signatures are correct, no further Signature Analysis Test are required. Disconnect the Signature Analyzer, set the A45 switches to the "OPEN" position and correct the defect indicated on the A33 Troubleshooting Tree.

2. If the signatures are incorrect, the trouble may be on the LO Control Board (A34, Service Group B-5). Leave the Signature Analyzer connected and go to the LO Control Signature Analysis tree.

# SERVICE GROUP B-5 LO CONTROL

**Board No. A34**

**Part Number 03585-66534**

**INDEX:**

Title	Page No.
LO Control Troubleshooting Tree .....	11-212
A34 Line And Ext. Trigger Troubleshooting Tree .....	11-213/11-214
A34 Sweep Timing Troubleshooting Tree .....	11-215/11-216
A34 Divide By 20 Troubleshooting Tree .....	11-217/22-218
A34 -15V Power Supply Troubleshooting Tree .....	11-219
A34 5V Power Supply Troubleshooting Tree .....	11-220
LO Loop Lock Indicator Truth Table .....	11-221/11-222
LO Loop Lock Indicator Failure Table .....	11-221/11-222

**ADJUSTMENTS:**

Component	Adjusted Parameter	Paragraph Location
A34R32	5V Power Supply	5-13

**TROUBLESHOOTING NOTES:**

1. Many of the questions in this Troubleshooting Tree refer to pulses. These pulses are quite narrow (10 $\mu$ sec) but occur at a slow rate ( $\approx$  220msec). Use "normal" triggering on your oscilloscope in order to see these pulses. In most cases the presence of the pulse is the important quantity, rather than the pulse polarity.

**A34 Board Signature Analysis Tests.**

Equipment Required: Signature Analyzer (-hp- Model 5004A).

- a. Turn the instrument off.
- b. On the A45 board (tabs = Yellow/Green), set DIP test switches 2, 3 and 6 to the "on" (inboard) position. Verify that all other A45 test switches are in the "OPEN" (outboard) position.
- c. Connect the Signature Analyzer as follows:

START and STOP-----A45 TP1  
 CLOCK-----A45 TP2  
 GND-----A45 "GND" Test Point

d. Set the Signature Analyzer controls as follows:

START ----- / (out)  
 STOP----- \ (in)  
 CLOCK----- / (out)  
 HOLD----- off (out)  
 SELF TEST----- off (out)

e. Turn the 3585A (and Signature Analyzer) on.

f. At this point, the CRT screen should be blank, the front-panel LED indicators should be flashing and the red LED on the A45 board should be flashing.

To verify that your test setup is correct and the test routine is running properly, touch the Signature Analysis test probe to A34TP5.

The signature should be "C2HH".

g. Check for the following signatures:

A34J1 Pin	Signature
A15	55P4
A16	A030
B12	F1HU
B13	27CF
B14	OCHO
B15	P6PU
B16	810F

1. If signatures are correct, go to Step h.

2. If signatures are incorrect, trouble is on I/O board (A45, Service Group 11-C-3-1) or lines are being loaded by the A34 board.

h. Check the following signatures:

Location	Signature
U2( 1)	C73F
U2( 4)	H57F
U2(10)	P19F
U2(13)	U36C
U3( 1)	U05C

1. If the signatures are correct, go to Step j.

2. If the signatures are incorrect, go to Step i.



i. Check the following signatures:

U1 Pin	Signature
2	4UPF
5	1P51
7	A2A8
10	7F03
12	7320

1. If the signatures are correct, replace U2 unless the signature at U3(1) was in error, then replace U3.
2. If the signatures are incorrect, replace U1.

j. Check the signatures for U4 if you entered these tests from the A34 Sweep Timing Troubleshooting Tree or the A28 board. If you entered these tests from the A26 board check the signatures for U5 and U6.

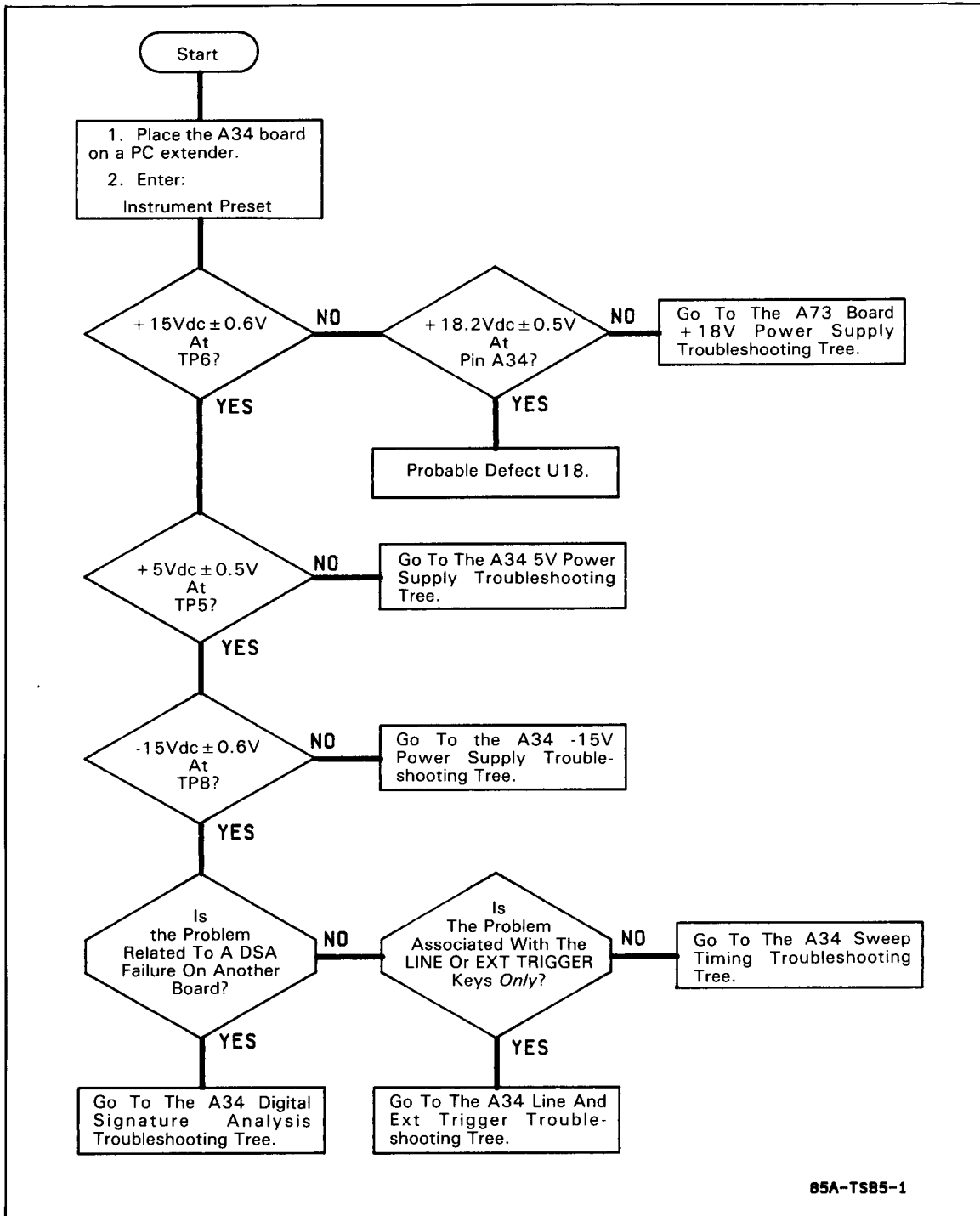
U4 Pin	Signature
2	1010
3	A2FH
6	166C
7	A4C6
10	F684
15	FUP6

1. If the signatures are correct, the Probable Defect is U8.
2. If the signatures are incorrect, replace U4.

U5 Pin	Signature
2	A59C
7	FAP9
10	7379
15	CUUU

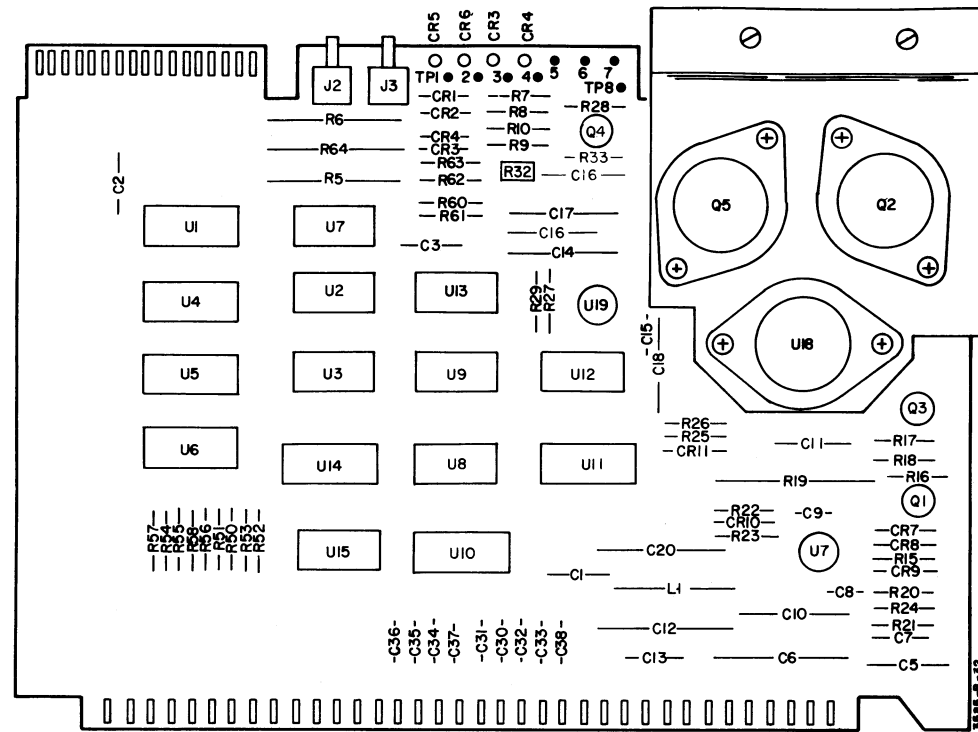
U6 Pin	Signature
2	3791
5	80F8
7	98CA
10	2274
15	0U77

3. If the signatures are correct, the Probable Defect is A26U2,3.
4. If the signatures are incorrect, replace U5 or U6 respectively.

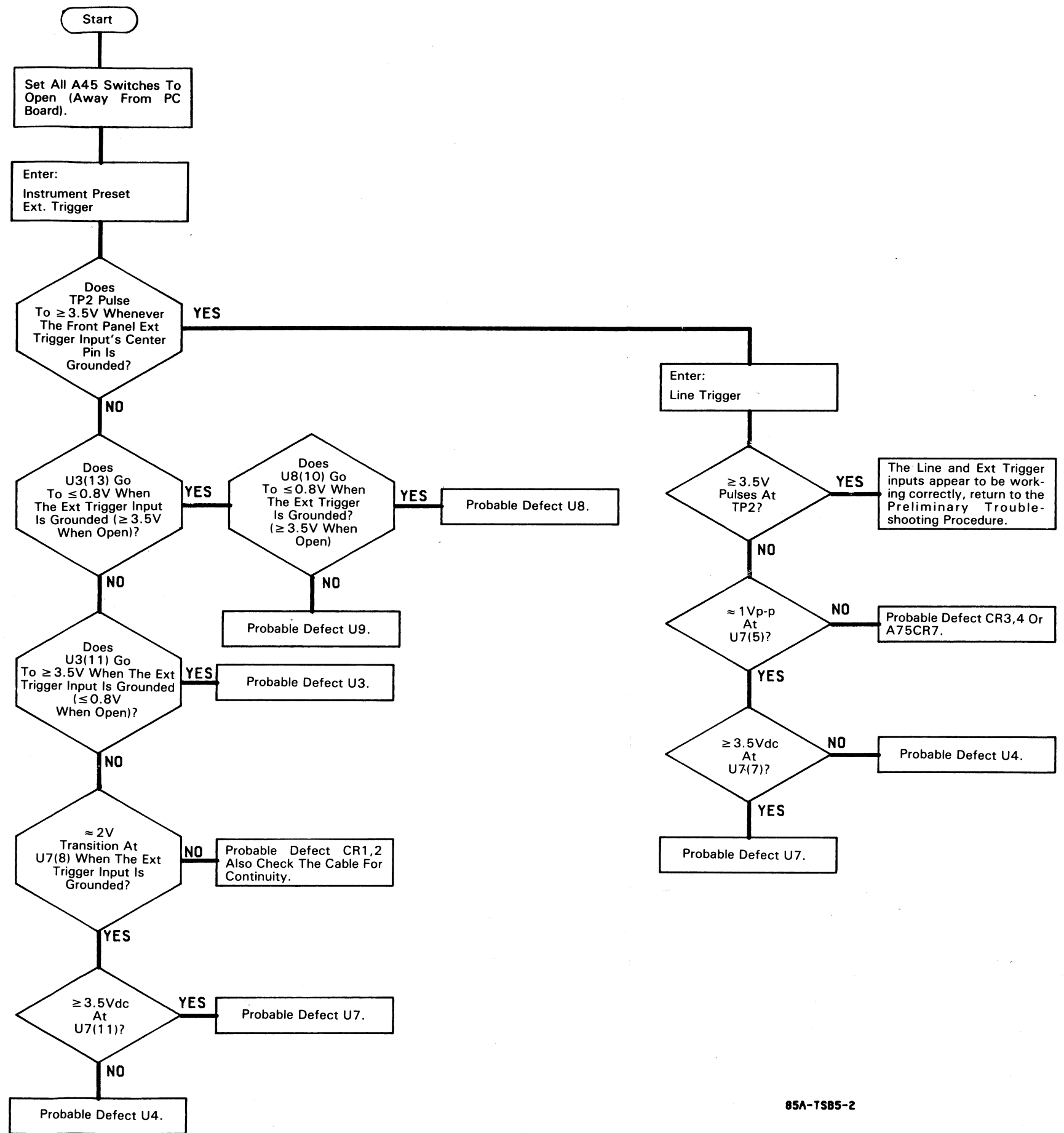


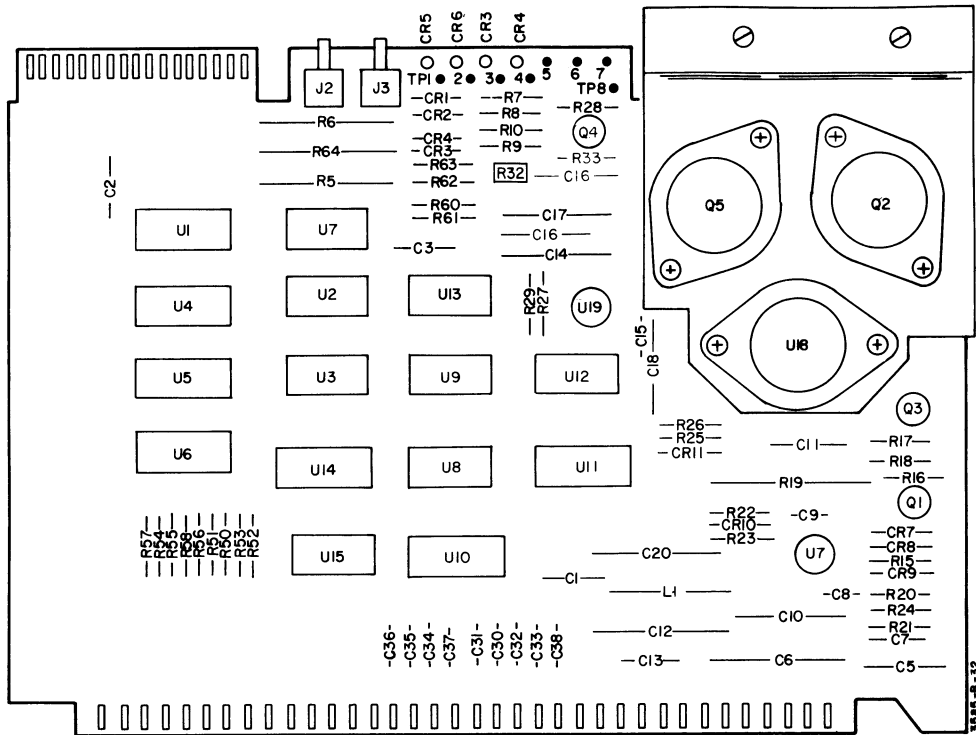
85A-TS85-1

LO Control (A34) Troubleshooting Tree.



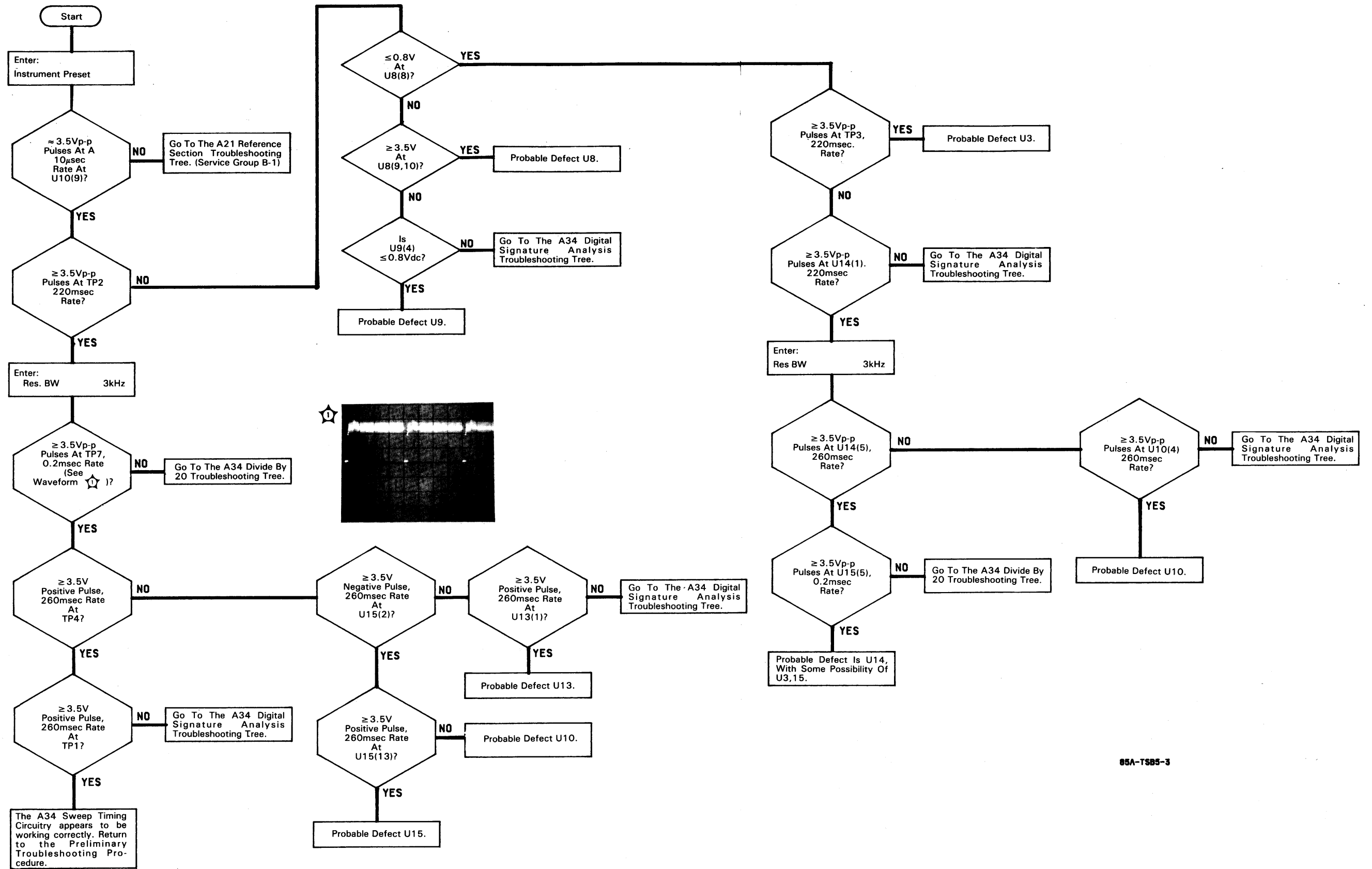
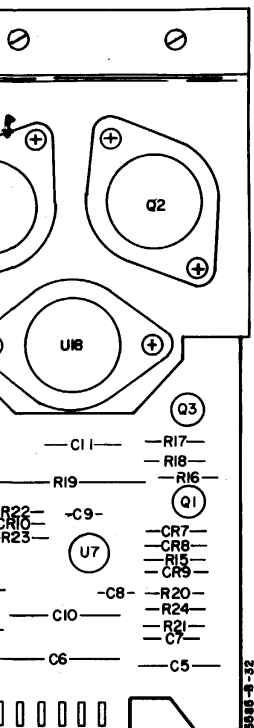
A34  
03585-66534



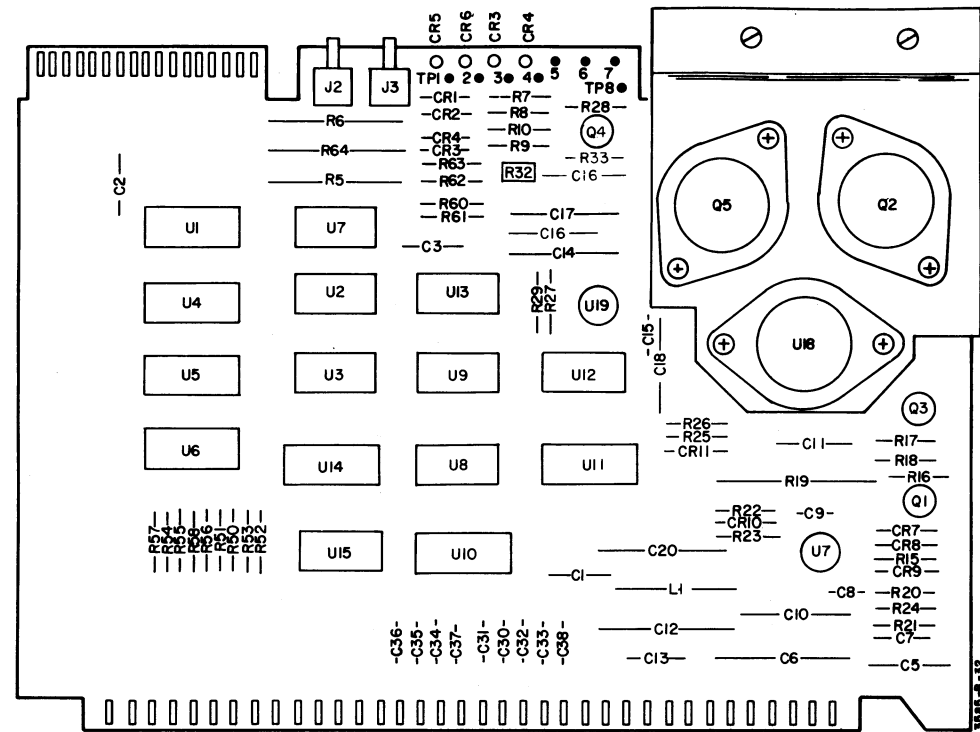


A34  
03585-66534

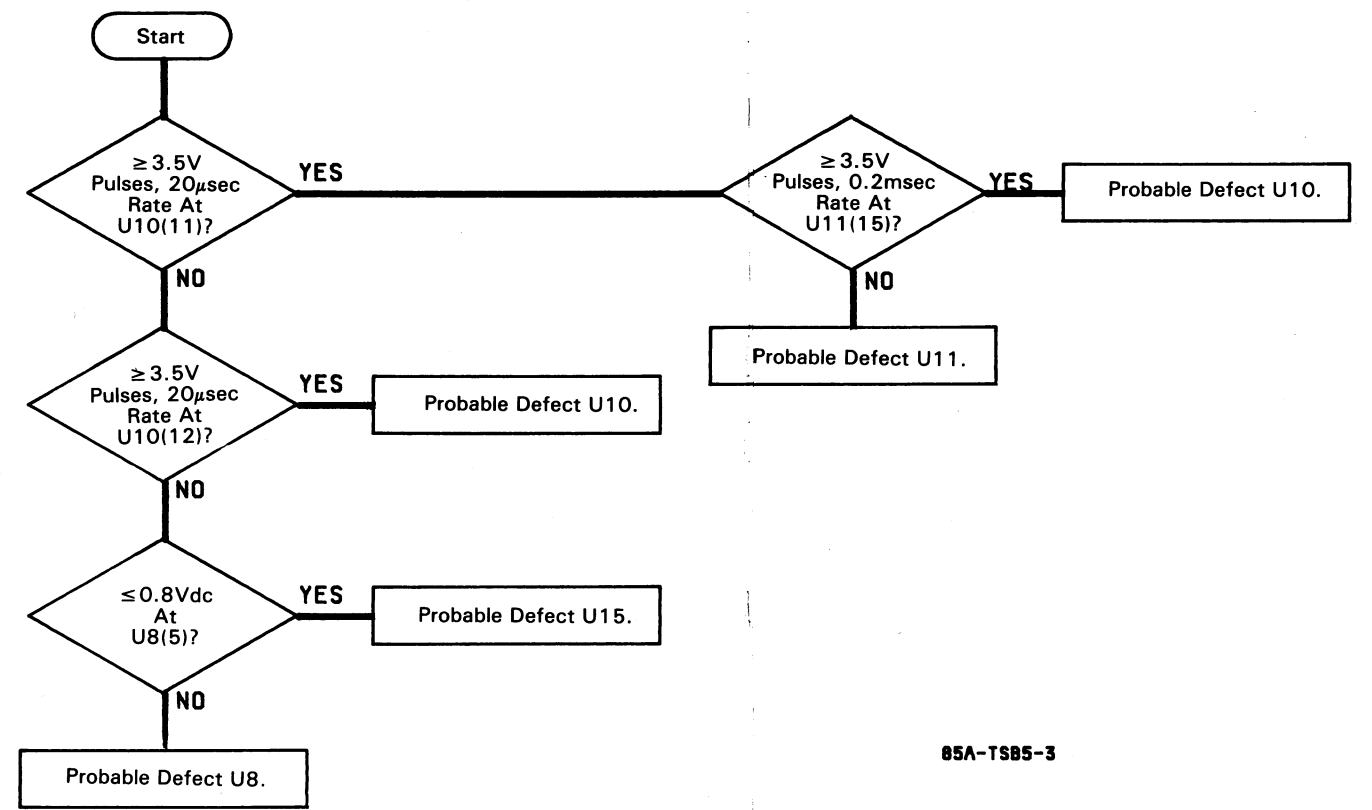
3585-8-32



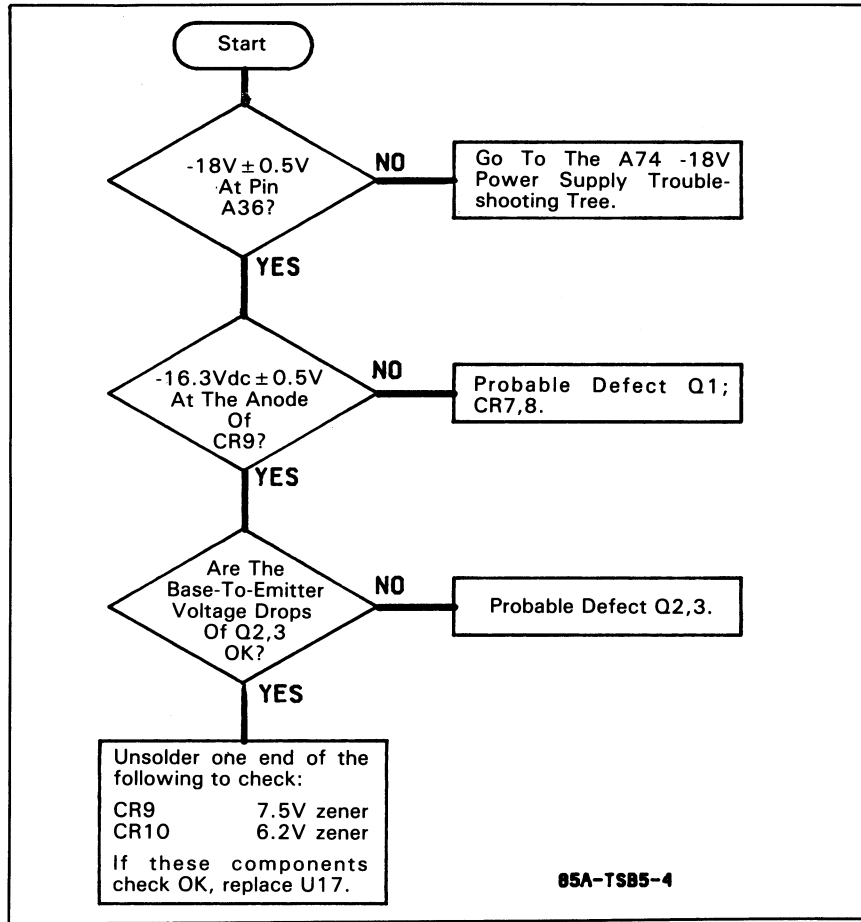
85A-TS85-3



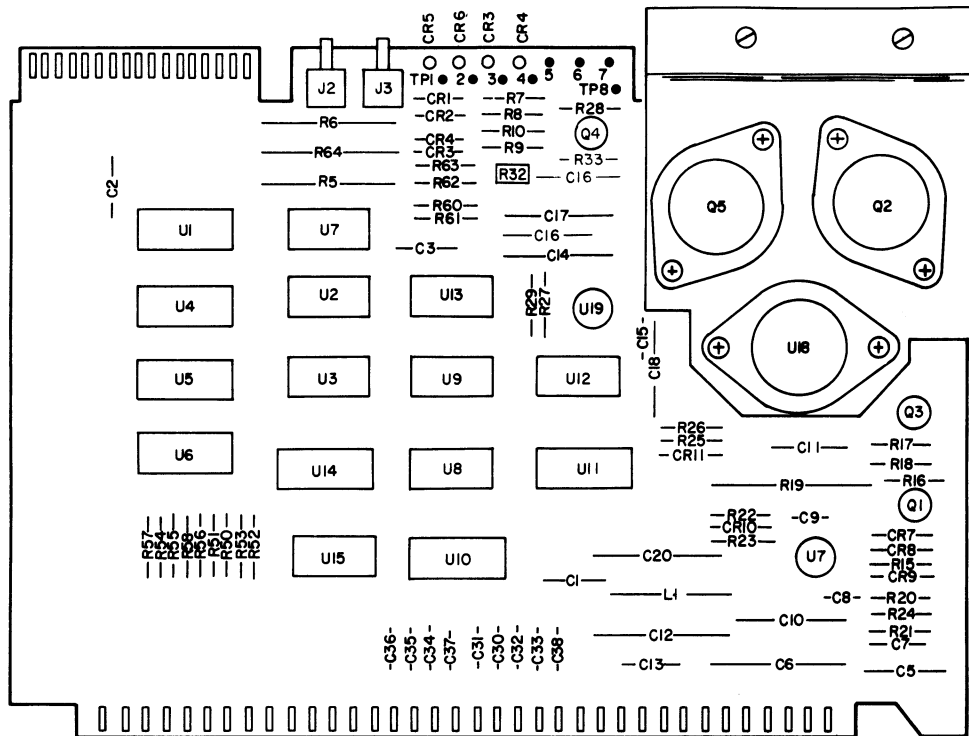
A34  
03585-66534



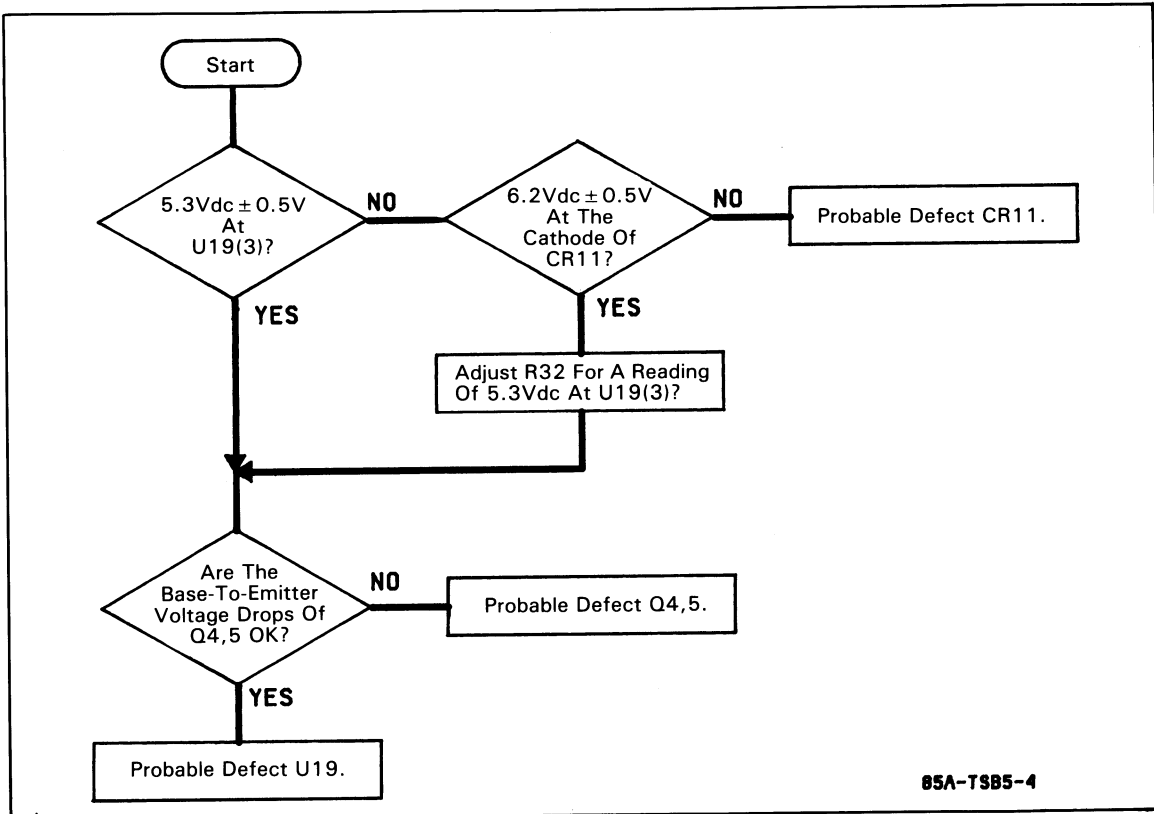
85A-TS85-3



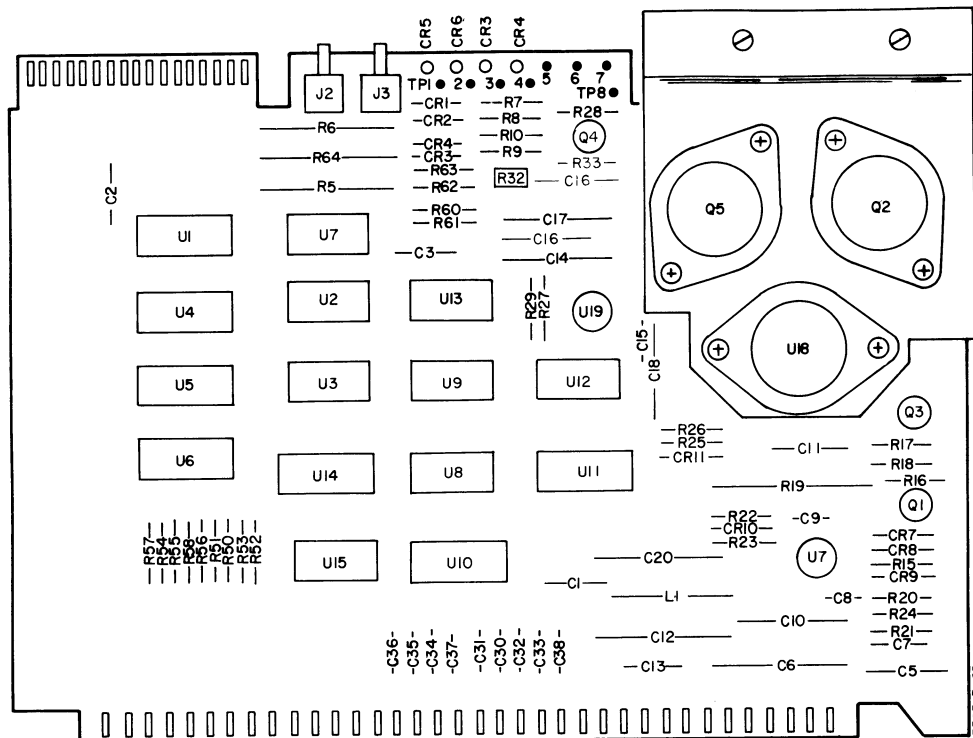
**A34 -15V Power Supply Troubleshooting Tree.**



**A34**  
**03585-66534**



**A34 5V Power Supply Troubleshooting Tree.**



**A34**  
**03585-66534**



**NOTE**

*If there is some doubt as to validity of the A34 Loop Lock LED's (A34CR3-6) the following checks may be performed. These checks assume that the Local Oscillator is operating properly according to Counter readings taken at A22J1. If your readings do not agree with Table 11-B-5-1 refer to Table 11-B-5-2.*

**Table 11-B-5-1. LO Loop Lock Indicator Truth Table**

LED Checked	Operation	U12 Input(Pin)	U12 Output(Pin)	LED State	U13(8)
REF(CR5)	● Connect a 10MHz, +4dBm signal to the 3585's EXT REF IN.	L(1,2)	H(3)	off	L
	● Change the frequency to 10.001MHz.	H(1,2)	L(3)	on	H
FRN(CR6)	● Manual Sweep	L(4,5)	H(6)	off	L
	● Disconnect A32J1	H(4,5)	L(6)	on	H
STEP(CR2) SUM(CR3)	● Manual Sweep	L(9,13) H(10,12)	H(8,11)	off	L
	● Disconnect A21J6 Enter: Res BW 3kHz	H(9,10,12,13)	L(8,11)	on	H

**Table 11-B-5-2. LO Loop Lock Indicator Failure Table**

U12 Input	U12 Output	LED State	U13(8)	Probable Defect
good	good	bad	good	LED
good	bad	bad	bad	U12
bad	bad	bad	bad	For: REF - A21U25 FRN - A31U10 STEP - A26U10 SUM - A28U3
good	good	good	bad	U13
good	good	good	good	If LOCAL OSC UNLOCKED is displayed, go to the A45 Digital Signature Analysis Troubleshooting Tree (Service Group 11-C-3-1), check U7.

## SERVICE GROUP C CENTRAL PROCESSOR

**Board Numbers A41-43, 45, 47**

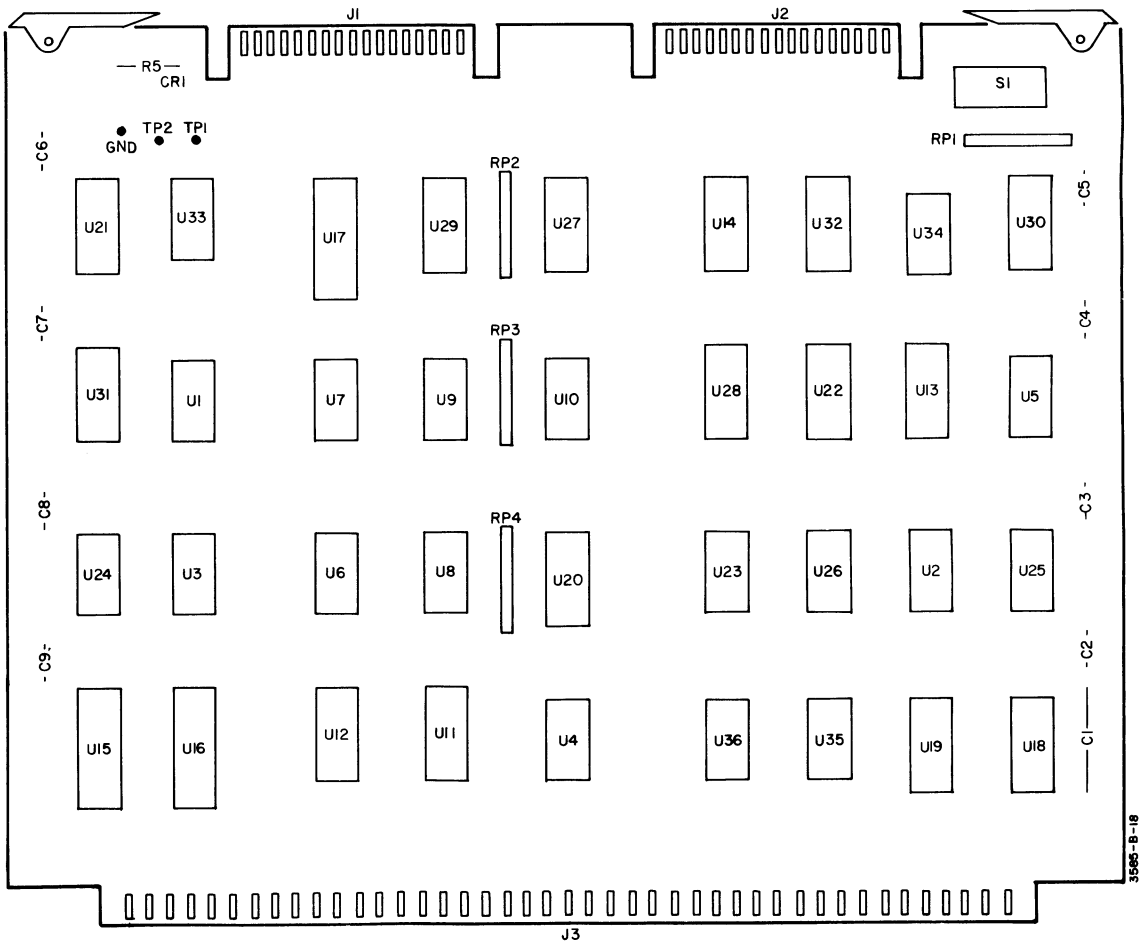
**Part Numbers 03485-66541, -66542, -66543, -66545, -66547**

### INDEX:

Title	DSA Test #	Page No.
Central Processor Troubleshooting Tree		11-225/11-226
Digital Section Mnemonic Table		11-227
Processor/Memory I/O Test	11-C-1-1	11-229
Processor Self Test	11-C-1-2	11-231
Processor Memory Control Test	11-C-1-3	11-233
Processor Memory I/O Control Test	11-C-1-4	11-235
ROM Checksum Test	11-C-2-1	11-237
RAM Refresh Verification	11-C-2-2	11-239/11-240
RAM Verification	11-C-2-3	11-241/11-242
RAM DSA Test	11-C-2-4	11-243
RAM Refresh ASM Test	11-C-2-5	11-245
ROM Address/Chip Select Test	11-C-2-6	11-249
ROM Data Test	11-C-2-7	11-253
I/O Data Output Test	11-C-3-1	11-255
CRT Test Pattern	11-C-3-2	11-265
DMA Request Circuitry Test	11-C-3-3	11-269/11-270
Low Level Interrupt (LDMAIR) Test	11-C-3-4	11-271/11-272
High Level Interrupt (HADIR) Test	11-C-3-5	11-273/11-274
Keyboard Test	11-C-4-1	11-275
Keyboard LED Test	11-C-4-2	11-279
Keyboard Key Replacement		11-281
Keyboard LED Replacement Procedure		11-282
Front Panel "Knob" Troubleshooting Procedure		11-283/11-284

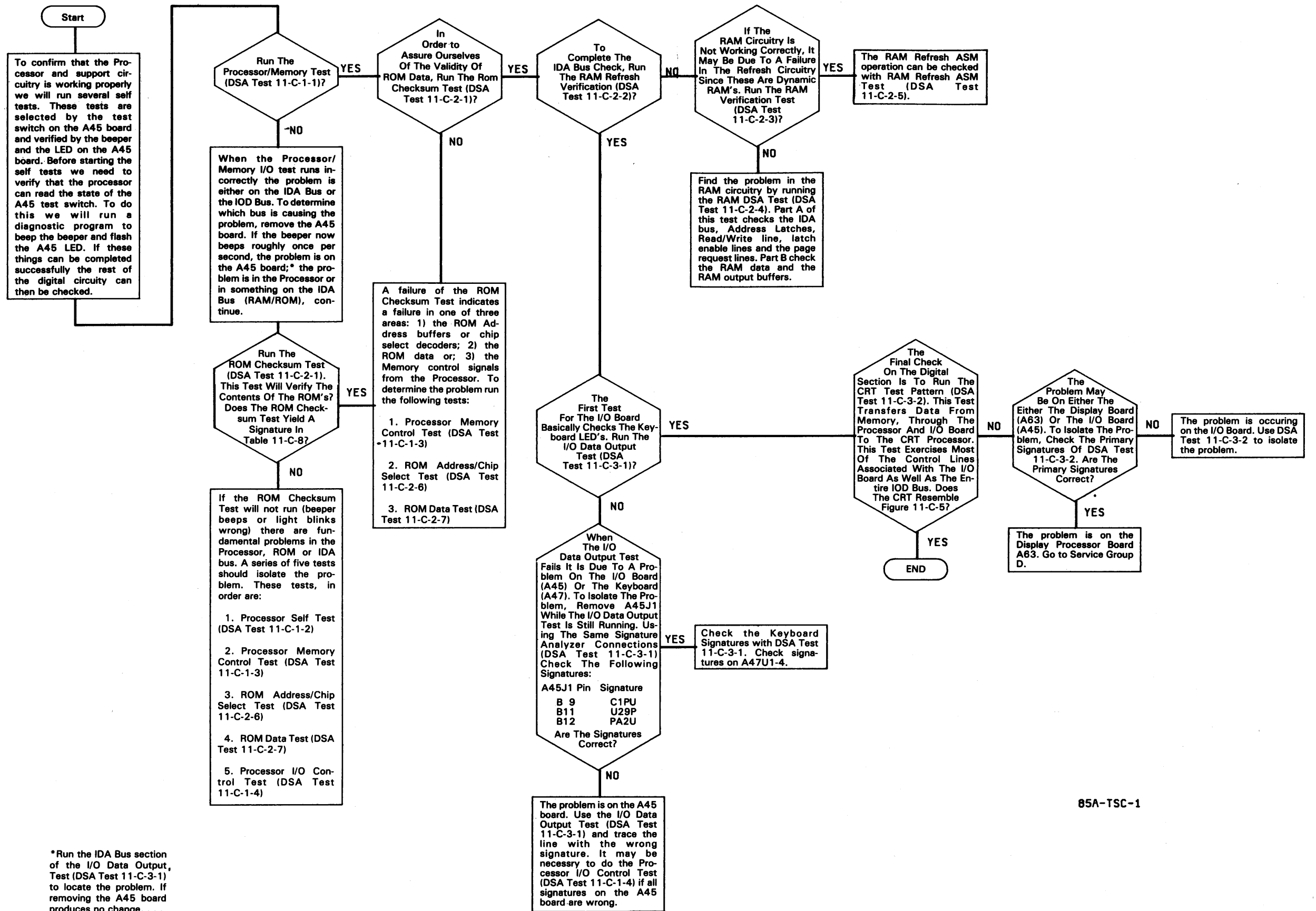
### ADJUSTMENTS:

None



3585-B-18

A45  
03585-66545



85A-TSC-1

Figure 8-C-2. Main Central Processor Troubleshooting Tree  
11-225/11-226

**Table 11-C-1. Digital Section Mnemonic Table  
Processor**

Mnemonic	Description
LIC1	Interface Control
LIC2	
LPA0-3	Peripheral Address 0-3
LIO SB	I/O Strobe
LDO UT	Data Output
L I N I T	Initialize (caused by resetting processor)
L I N T	Interrupt Poll (coupled w/LPA3 – H = high lvl int., L = low lvl int.)
LIOD0-15	I/O Data
L I R L	Interrupt Request, Low Level (LPA0-7)
L I R H	Interrupt Request, High Level (LPA8-15)
LDMAR	DMA Request
LFLG	Flag-used with PA0-15 to indicate LO unlocked,
LSTS	STATUS of the sweep tracking generator absent or A/D during calibration.
LRESET	Instrument Preset ANDed with not Remote (LREM).
LDCLR	Device Clear from HP-IB.
LIDA0-15	Instruction/Data/Address.
LRBFO	ROM Buffer Output (buffer enable).
LSOB	Stay off bus (during lower 40 <sub>8</sub> addresses).
LSTM	Start Memory
LSTMR	Start Memory Return
LWRIT	Read/Write
LSTMROM	Start Memory ROM
LSTMROMR	Start Memory Return
LMEB	Memory Busy
O2	Phase 2 Clock
PBE	Peripheral Buffer Enable
PBO	IDA Buffer Enable
BYTE	BYTE Date Transfer
UMC	Unsynchronous Memory Complete
RAL	Register Address Line
Writ	Read/Write
STM	Start Memory
PDR	Processor Driving IDA Lines
SMC	Synchronous Memory Complete
LIPST	Instrument Preset (front panel green key).
RPG1,2	Rotary Pulse Generator Outputs.

**Table 11-C-1. Digital Section Mnemonic Table (Cont'd)**  
**I/O**

Mnemonic	Description
DMAO-15 DMARF LNPINT LDMARQ LDMAIR LDSP	Display Data. DMA Request Flag. Nanoprocessor Interrupt (Main Processor ready). DMA Request (A63 needs new data) Highest Priority. DMA Interrupt Request (initiates display cycle) 17ms. Display Board Resident.
LSC05 LSC17	Select Code 05 - HP-IB Select. Select Code 17 - Counter Select.
HADCO-9 HADIR	A/D Data. A/D Interrupt Request (data ready).
LTRIP LRNGD LRNGU H5DB H10DB H20DB H20HP HLOZ H75Ω HCAL	Input Termination Tripped. Down Range (signal too small). Up Range (signal too large). 5dB Pad Control. 10dB Pad Control. 20dB Pad Control. 20dB High Power Pad Control. Terminated/High Impedance Input Select. 50/74 ohm Input Select. Calibration in progress (terminates input w/dummy load and connects internal calibrator).
TGCL5 TGCL6 HTGBO-5 HCAL	Clock for 6 next MSB for Tracking Generator D/A. Clock for 6 MSB for Tracking Generator D/A. Tracking Generator Data. Calibration in progress (terminates input w/dummy load and connects internal calibrator).
LTGIN	Tracking Generator Resident.
HSWP LLOCK LODA0-4 LOADCK LODACK	Sweep in Progress. LO is Locked. LO Data/Latch Address. LO Address Clock. LO Data Clock.
IFBO-5 IFACL IFDCL	IF Latch Address/Data. IF Address Clock. IF Data Clock.
LOVLI LSWPI LIDIN LIDCL LIXCL HRPGR LROW0-7 LCOLO-8 LRPG0-3 LCW LIPST LREM	Overlead Indicator. Sweep Indicator. Indicator Data. Indicator Data Clock. Indicator Data Latch Clock. RPG Reset. Key Row 0-7. Key Column 0-8. RPG Counter Data. RPG Clockwise Rotation. Instrument Preset. Remote Enabled.

## DSA Test No. 11-C-1-1 Processor/Memory I/O Test

Turn the 3585A power off.

**Areas Tested:**

- I/O Control Bus
- Beeper
- A45 LED
- IOD Bus
- Test Switch

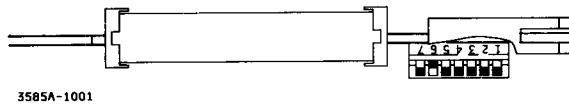
**Remove Boards:**

N.A.

**Place on PC Extender:**

A45 (only if the test runs incorrectly)

**Set A45 Test Switch to:**



(Black indicates switch position)

**Connect the Signature Analyzer as follows:**

START and STOP .....	A45TP1
CLOCK .....	A45TP2
GND .....	Chassis Ground

**Set the Signature Analyzer controls as follows:**

START .....		(out)
STOP .....		(in)
CLOCK .....		(out)

Turn the 3585 power on.

**The test is running correctly when:**

- The beeper is beeping ≈ once per second.
- The A45LED is changing states at ≈ once per second.
- The 5V signature (A45 pin A38) reads 9FFP.

**If the test is running correctly, do the following:**

1. Continue with the next step on the Central Processor Troubleshooting Tree.

**If the test is running incorrectly:**

1. Remove the I/O board (A45).
  - a. If removal of the board causes the beeper to beep at the correct rate the problem may be on the A45 board. Continue at step 2.

- b. If the removal of the board does not cause the beeper to beep at the correct rate, return to the Central Processor Troubleshooting Tree for further instructions.
2. With the I/O board on an extender, check the Primary Signatures in Table 11-C-2.
- a. If the signatures are good, replace the A45 board and check the Secondary Signatures in Table 11-C-3. The Probable Defect is U30, U36d, U18 or U19.
  - b. If the signatures are bad, go to the Processor Self test (DSA Test 11-C-1-2). Also perform DSA Tests 11-C-1-3, 11-C-2-6, 11-C-2-7 and 11-C-1-4 if necessary to isolate the problem.

**Table 11-C-2. Processor/Memory I/O Primary Signatures**

A45 Pin	Signature	A45 Pin	Signature
A21	H757	B21	9C35
A22	9C88	B22	1213
A23	822H	B23	C19C
A24	H7AU	B24	C874
A25	02U6	B25	6187
A26	2070	B26	7669
A27	9C4H	B27	H3H1
A28	2657	B28	1146
A31	052C	B32	0000
A33	7H52	B33	9928
A34	1UH0	B34	P2FA
A35	968A	B35	99U4

**Table 11-C-3. Processor/Memory I/O Secondary Signatures**

+ 5 V = 9FFP							
U18 Pin	Signature	U19 Pin	Signature	U30 Pin	Signature	U36	Signature
6	9FFP	5	0000	2	9FFP	8	9FFP
7	CF9F	7	9FPU	4	9FFP	9	0000
9	HF6C	9	9F8P	6	9FFP		
10	1H84	10	9F4U	10	9FFP		
11	9P5C	11	9HFF	12	9FFP		
12	871C	12	9PFC	14	9FFP		
13	9FHO	13	98F4				
14	C59A	14	94HA				
15	FP67	15	8FP7				



# DSA Test No. 11-C-1-2 Processor Self Test

Turn the 3585A power off.

Areas Tested:

Processor and IDA bus outputs.

Remove Boards:

- A42 (RAM)
- A43 (ROM)

Place on PC Extender:




A41 (Processor)

Place A41JMP1 in the "Test" position.

Connect the Signature Analyzer as follows:

START and STOP .....	A41TP6
CLOCK .....	A41TP2
GND .....	Chassis Ground

Set the Signature Analyzer controls as follows:

START .....		(out)
STOP .....		(out)
CLOCK .....		(in)

Turn the 3585A power on.


The test is running correctly when:

- The signature at A41 pin A38 (5V) reads 8708.
- Only one beep occurs after power is applied.

If the test is running correctly, do the following:

1. Check the signature in Table 11-C-4.

If the test is running incorrectly try the following:

1. With an oscilloscope, check U13(20,21). Both pins should have 6MHz,  $\geq 10Vp-p$  clock signals.
  - a. If both pins have the proper clock signal, go to step 2.
  - b. If the clock signal is not present, check pin A20 for a 12MHz,  $\geq 3.5Vp-p$  signal. If the 12MHz signal is present troubleshoot the Two-phase Clock Generator circuit U4-7. If the 12MHz signal is not present go to the Clock Board Troubleshooting, Service Group D-1.
2. Move the Signature Analyzer CLOCK probe to A41TP1.
3. Set the Signature Analyzer CLOCK control to  (out).

4. Move A41J2 to the "Test" position and momentarily short LRESET to the pin next to it.
  - a. If the 5V signature reads 3AOF, the probable defect is U20,21.
  - b. If the signature is not 3AOF, go to step 5.
5. Touch your logic probe to U13(11). Momentarily short the LRESET pin to the pin beside it.
  - a. If the logic probe shows a TTL high at all times *except* when you short the LRESET pin the probable defect is U13. Note that the logic probe should pulse once shortly after power on. If it does not the probable defect is Q2,CR1,C14. Before replacing U13, go to step 6.
  - b. If the logic probe always shows either a high or low state, troubleshoot the Reset circuit U2,6,7,14,17 or Q2.
6. Using a logic probe, check U12(11,12,13) for pulses.
  - a. If U12(11) is pulsing, the probable defect is U18.
  - b. If only U12(13) is not pulsing, the probable defect is U16,6 or U13(45,30).
  - c. If only U12(12) is not pulsing, the probable defect is U14,19,13.
  - d. If U12(12,13) are not pulsing, the probable defect is U13,12,18,16.

**Table 11-C-4. Processor Self Test IDA Bus Signatures**

+ 5 V = 8708			
A41 Pin	Signature	A41 Pin	Signature
A1	6H76	B1	C98C
A2	9A56	B2	4UCC
A3	9786	B3	H94C
A4	F9C3	B4	20AA
A5	HACF	B5	4C44
A6	8C6A	B6	8906
A7	655F	B7	51A2
A8	8708	B8	4384

- a. If the signatures are correct, the Processor and IDA Bus are OK. Return to the Central Processor Troubleshooting Tree for further instructions.
- b. If incorrect signatures occur, the Probable Defect is U13.

## DSA Test No. 11-C-1-3 Processor Memory Control Test

Turn the 3585A power off.

Areas Tested:

Memory Control Lines

Remove Boards:

A42 (RAM)  
A43 (ROM)

Place on PC Extender:




A41 (Processor)

Place A41JMP1,2 in the "Test" position.

Connect the Signature Analyzer as follows:

START and STOP .....	A41TP6
CLOCK .....	A41TP1
GND .....	Chassis Ground

Set the Signature Analyzer controls as follows:

START .....		(out)
STOP .....		(out)
CLOCK .....		(out)

Turn the 3585A power on.

The test is running correctly when:

- The 5V signature (A41 pin 38) reads 3AOF.

If the test is running correctly, do the following:

1. Check the following signatures:

A41 Pin	Signature	U17 Pin	Signature
A29	C2HP	11	08UC
A30	08UC		
A31	3F51		
A35	965P		
B31	3AOF		
B34	32U7		

- a. If the signatures are correct the Memory Control circuitry is OK. Return to the Central Processor Troubleshooting Tree for further instructions.
- b. If the signature for pin B34 is incorrect and the signatures for A29 and A35 are correct, Probable Defect is U20,21.

- c. If any other signature is wrong, check the signatures in Table 11-C-5. Use the schematic and Table 11-C-5 to trace down the problem.

If the test is running incorrectly, and Test 11-C-1-2 runs correctly:

1. Replace U14,13.

**Table 11-C-5. Memory Control Output Signatures**

IC Pin	Signature
U2 (12,13)	3AOF
U6 (1)	965P
U6 (2)	AF52
U6 (12)	C2HP
U6 (13)	88H2
U12 (9,10)	C2HP
U14 (5)	32U7
U14 (9)	AF52
U17(9)	1274
U17(10)	08UC
U19 (1)	C225
U19 (2)	AF52
U19 (3,4)	3AOF
U19 (5)	C2HP
U19 (8)	32U7

# DSA Test No. 11-C-1-4 Processor I/O Control Test

Turn the 3585A power off.

Areas Tested:

- Processor IOD Bus
- Processor I/O Control Lines

Remove Boards:

- A42 (RAM)
- A45 (I/O)
- A63 (Display Processor)

Place on PC Extender:




- A41 (Processor)

Place A41JMP1,2 in the "Normal" position.

Connect the Signature Analyzer as follows:

START and STOP .....	A41TP4
CLOCK .....	A41TP5
GND .....	Chassis Ground

Set the Signature Analyzer controls as follows:

START .....		(out)
STOP .....		(out)
CLOCK .....		(out)

Turn the 3585A power on.

The test is running correctly when:

- The beeper beeps approximately twice per second.
- The 5V signature (A41 pin A38) reads 9FFP.

If the test is running correctly, do the following:

1. Check the signatures in Table 11-C-6.
  - a. If the signatures are good, the problem is on one of the removed boards. Replace the A42 and A63 boards and run the test again. If everything looks OK, replace the A45 board. The Probable Defect is the test switch, A45U30 or something loading the IOD Bus.
  - b. If the signatures are wrong, use Table 11-C-7 to locate the faulty component.

If the test is running incorrectly:

1. Run the ROM Address/Chip select test (DSA Test 11-C-2-6) and the ROM Data Test 11-C-2-7).

**Table 11-C-6. Processor I/O Control Lines Primary Signatures**  
+ 5 V = 9FFP

A41 Pin	Signature	A41 Pin	Signature
A11	3902	B11	1U33
A12	1U6H	B12	5CA0
A13	93CU	B13	0A64
A14	C97P	B14	OP93
A15	H3H2	B15	P26A
A16	F291	B16	699H
A17	1UOU	B17	CC41
A18	F182	B18	5AOA
A23	503F	B24	0000
A25	6F00	B25	1P3H
A26	5H41	B26	A3FF
A27	FC45	B27	9P53

**Table 11-C-7. Processor I/O Control Lines Secondary Signatures**  
+ 5 V = 9FFP

U1 Pin	Signature	U2 Pin	Signature	U9 Pin	Signature
4,5	503F	1,2 4,5	9P53 FC45	1,2 4,5 9,10 12,13	5H41 6F00 1P3H A3FF

## DSA Test No. 11-C-2-1 ROM Checksum Test

Turn the 3585A power off.

Areas Tested:

ROM Data

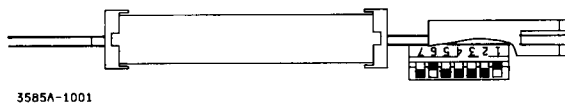
Remove Boards:

NA

Place on PC Extender:

A43 (ROM) if necessary

Set A45 Test Switch to:



(Black indicates switch position)

Connect the Signature Analyzer as follows:

START and STOP .....	A45TP1
CLOCK .....	A43TP5
GND .....	Chassis Ground

Set the Signature Analyzer controls as follows:

START .....			(out)
STOP .....		(in)	
CLOCK .....		(out)	

Turn the 3585A power on.

The test is running correctly when:

- The beeper *is not* beeping.
- The A45LED is flashing at  $\approx$  once per second.
- The 5V signature (A43 pin A38) reads CCA3.

If the test is running correctly, do the following:

1. Return to the Central Processor Troubleshooting Tree for further instructions.

If the test is running incorrectly:

1. See Table 11-C-8 for a list of signatures which show where bad ROM data is occurring. Note that this test is not extensive enough to determine if the error is occurring because of a buffer or a ROM. Therefore, run both the ROM Address/Chip select test (DSA Test 11-C-2-6) and the ROM Data test (DSA Test 11-C-2-7) to locate the problem. Also note that once something has been fixed on the ROM board this test (11-C-2-1) should be run again to confirm that there are not multiple errors in the ROM's.

Use the Table 11-C-9 to determine which parts to check during DSA Test 11-C-2-6,7.

**Table 11-C-8. ROM Checksum Signatures**

Probable Defective ROM	5V Signature
U1	8061 F5AC 9UC1 U101
U2	15C4 H90P 063F 0AHU
U3	9A2A U2U6 A39F 70F9
U4	1CAF 31H7 207H PC43
U5	U718 96AP UH70 FHC7
U6	C96U C6U4 PA27 7H4P
U7	4914 7672 FCU3 3P94
U8	224A 286C 2P96 5551

**Table 11-C-9. ROM Error Troubleshooting.**

Signature Failure For IC #	DSA Test 11-C-2-6	DSA Test 11-C-2-7
U1,3,5,7 U2,4,6,8	U10-13,14 U10-13,15	Individual IC Individual IC



# DSA Test No. 11-C-2-2 RAM Refresh Verification

Turn the 3585A power off.

Areas Tested:

RAM Data Retention

If the refresh circuitry is not working correctly an error will be shown.

Remove Boards:

NA

Place on PC Extender:

NA

Set A45 Test Switch to:



(Black indicates switch position)

Connect the Signature Analyzer as follows:

START and STOP .....	NA
CLOCK .....	NA
GND .....	NA

Set the Signature Analyzer controls as follows:

START .....	NA
STOP .....	NA
CLOCK .....	NA

Turn the 3585A power on.

The test is running correctly when:

- The beeper does not beep.
- The A45LED changes state about every three seconds.

If the test is running correctly, do the following:

1. Return to the Central Processor Troubleshooting Tree for further instructions.

If the test is running incorrectly:

1. Return to the Central Processor Troubleshooting Tree for further instructions.

# DSA Test No. 11-C-2-3 RAM Verification

Turn the 3585A power off.

Areas Tested:

RAM

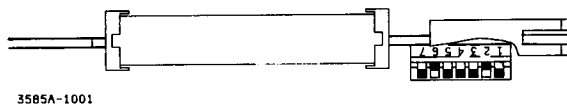
Remove Boards:

NA

Place on PC Extender:

NA

Set A45 Test Switch to:



(Black indicates switch position)

Connect the Signature Analyzer as follows:

START and STOP . . . . .	NA
CLOCK . . . . .	NA
GND . . . . .	NA

Set the Signature Analyzer controls as follows:

START . . . . .	NA
STOP . . . . .	NA
CLOCK . . . . .	NA

Turn the 3585A power on.

The test is running correctly when:

- The beeper does not beep.
- The A45LED changes state about every four seconds.

If the test is running correctly, do the following:

1. Return to the Central Processor Troubleshooting Tree for further instructions.

If the test is running incorrectly:

1. Return to the Central Processor Troubleshooting Tree for further instructions.

# DSA Test No. 11-C-2-4 RAM DSA Test

Turn the 3585A power off.

**Areas Tested:**

- IDA bus
- Address Latches
- Read/Write Line
- Memory Address Control Lines

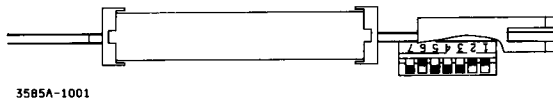
**Remove Boards:**

NA

**Place on PC Extender:**

A42 (RAM)

**Set A45 Test Switch to:**



(Black indicates switch position)

Place A42J1 in the "Test" position.

**Connect the Signature Analyzer as follows:**

- START and STOP . . . . . A45TP1
- CLOCK . . . . . A42U36(11)
- GND . . . . . Chassis Ground

**Set the Signature Analyzer controls as follows:**

- START . . . . . (out)
- STOP . . . . . (in)
- CLOCK (for Table 11-C-10,11) . . . . . (in)
- CLOCK (for Table 11-C-12) . . . . . (out)

Turn the 3585A power on.

The test is running correctly when:


- The 5V signature (A42 pin A38) reads F60F.

If the test is running correctly, do the following:

**NOTE**

*The signatures used in this test are gated at a very slow rate, approximately 8 seconds per signature. Be sure to allow the gating cycle to complete before reading the signature.*

1. Check the Signatures in Table 11-C-10.
  - a. If the signatures are correct, go on to step 2.
  - b. If the signatures are wrong, use Table 11-C-11 and the schematic to locate the problem.
2. Change the Signature Analyzer controls as follows:
 

CLOCK .....  (out)
3. Check the signatures in Table 11-C-12.
  - a. If the signatures are correct return to the beginning of the Central Processor Troubleshooting Tree and recheck the symptoms.
  - b. If the signatures are wrong, use the schematic to locate the problem.

If the test is running incorrectly:

1. The problem may be that the LSTM line that is connected to the Signature Analyzer CLOCK input is stuck high or low. Check A42U36(11) with a logic probe, it should be pulsing. If it is not, run DSA Test 11-C-1-3 to find the problem with the line.

**Table 11-C-10. RAM DSA Test - Part A Primary Signatures**

CLOCK .....  (in)

+ 5 V = F60F

A42 Pin	Signature	A42 Pin	Signature	U25 Pin	Signature
A1	A28F	B1	FF27	2	744F
A2	F2C3	B2	6C79	3	P613
A3	233P	B3	A788	4	34CF
A4	93C8	B4	HF2H	8	1038
A5	1038	B5	4668	9	91C9
A6	UP67	B6	HUA3	10	4668
A7	9937	B7	9C36	12	F60F
A8	F60F	B8	F865	13	HF2H
A30	0000	B22	F60F	14	HUA3
A32	0001			15	UP67
A35	F60F	B31	C3FP	19	C794/ C595
				20	77FP
				21	F453

**Table 11-C-11. RAM DSA Test - Part A Secondary Signatures**  
 CLOCK ..... (in)

+ 5 V = F60F

U18 Pin	Signature	U26 Pin	Signature	U28 Pin	Signature	U30 Pin	Signature
2	UP67	1	0000	4	0000	2	F453
4	UP67	2	HF2H	6	F60F	3	F2C3
5	HUA3	4	HF2H			4	A788
7	HUA3	5	91C9			5	77FP
1	0000	7	91C9			6	233P
		9	1038			7	C794
		11	1038			10	34CF
		12	4668			11	6C79
		14	4668			12	P613
						13	FF27
						14	A28F
						15	744F

U33 Pin	Signature	U34 Pin	Signature	U35 Pin	Signature	U36 Pin	Signature
10	F865	2	HF2H	1,2	0000	1	0000
15	UP67	3	93CA	3	F60F	2	F865
16	HUA3	6	4668	4	0000	3	F60F
		7	1038	5	77F3	4	F60F
		9	1038	6	F60F	8,9	C3FP
		10	4668	8	F60F	10	77F3
		15	93CA	9	0000	11,12	F60F
		16	HF2H	12	F60F	13	0000
				13	0000		

**Table 11-C-12. RAM DSA Test - Part B Secondary Signatures.**  
 CLOCK ..... (out)  
 + 5 V = F60F

U18 Pin	Signature	U26 Pin	Signature	U28 Pin	Signature
1	0000				
2	UP67	1	0000	4	0000 F60F
4	UP67	2	HF2H	6	
5	HHA2	4	HF2H		
7	HHA2	5	91C9		
		7	91C9		
		9	1038		
		11	1038		
		12	4668		
		14	4668		

U35 Pin	Signature	U36 Pin	Signature
1,2	1C60/ 1C62	1	OP69
3	F60F	2	F865
4	OP69	3	0000
5	75F2	4	0000
6	UACC	8,9	C3FP
8	0000	10	75F2
9	F60F	11,12	0000
12	U4H2	13	F60F
13	OP69		

\*Table 11-C-13 has been deleted.

# DSA Test No. 11-C-2-5 RAM Refresh ASM Test Part A

Turn the 3585A power off.

Areas Tested:

Refresh Address ASM	}	Part A
Refresh Address Counter		
Refresh Address Multiplexer		

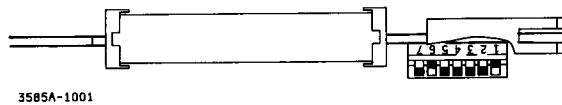
Remove Boards:

NA

Place on PC Extender:

A42 (RAM)

Set A45 Test Switch to:






(Black indicates switch position)

Connect the Signature Analyzer as follows:

START and STOP	.....	A42U19(1)
CLOCK	.....	A42TP3
GND	.....	A42 Ground Plane

Set the Signature Analyzer controls as follows:

START	.....		(in)
STOP	.....		(out)
CLOCK	.....		(in)

Turn the 3585A power on.

The test is running correctly when:

- The 5V signature (A42 pin A38) reads 0007.

If the test is running correctly, do the following:

1. Go to Part B.

If the test is running incorrectly, the refresh ASM must be checked with a logic probe and pulser. See Figure 11-C-5 for a simplified ASM diagram.




## RAM Refresh ASM Test Part B

Turn the 3585A power off.

Connect the Signature Analyzer as follows:

START and STOP ..... A42TP2  
 CLOCK ..... A42U19(1)  
 GND ..... A42 Ground Plane

Set the Signature Analyzer controls as follows:

START .....  (out)  
 STOP .....  (out)  
 CLOCK .....  (out)

Turn the 3585A power on.

The test is running correctly when:

- The 5V signature (A42 pin A38) reads 6PCP.

If the test is running correctly, do the following:

1. Check the signatures in Table 11-C-14.
  - a. If the signatures are correct, it indicates that the Refresh circuitry is performing correctly. If the RAM circuitry still appears to be the problem run the RAM DSA test (DSA test 11-C-2-4).
  - b. If the signatures are incorrect, find the faulty component using the secondary signatures and the schematic.

**Table 11-C-14. RAM Refresh Multiplexer/Counter DSA Test  
Part B**

Primary Signatures			
U25 Pin		Signature	
8		5A34	
9		3CPF	
10		91FC	
13		2595	
14		1F8F	
15		U97F	
Secondary Signatures			
U19 Pin	Signature	U27 Pin	Signature
8	1F8F	8	91FC
9	2595	9	5A34
11	U97F	11	3CPF
		12	F9C2



# DSA Test No. 11-C-2-6 ROM Address/Chip Select Test Part A

Turn the 3585A power off.

**Areas Tested:**

- ROM Address Latches/Chip Select Decoder    Part A
- Composite ROM Data    Part B
- Output Buffers    Part B

**Remove Boards:**

A42 (RAM)

**Place on PC Extender:**

A43 (ROM)




**Special instructions for this test:**

A41J1 in the "Test" position. Remove A43U16, 17.

**Connect the Signature Analyzer as follows:**

START and STOP .....	A41TP6
CLOCK .....	A43TP5
GND .....	Chassis Ground

**Set the Signature Analyzer controls as follows:**

START .....		(out)
STOP .....		(out)
CLOCK .....		(in)

Turn the 3585A power on.

The test is running correctly when:

- The 5V signature (A43 pin A38) reads 8708.

If the test is running correctly, do the following:

1. Check the Primary Signatures contained in Table 11-C-15.
  - a. If the signatures are correct, go on to Part B.

If the signatures are incorrect:

1. If the Primary Signatures of Table 11-C-15 are wrong but the Secondary Signatures are correct, replace the component with the erroneous signature.
2. If the Secondary Signature is also wrong, the Processor may be sending out erroneous data or control signals. Run the Processor Self Test (DSA Test 11-C-1-2) and the Processor Memory Control Test (DSA Test 11-C-1-3) to find the problem.

## ROM Address/Chip Select Test Part B

Change the Signature Analyzer controls to:

CLOCK .....  (in)

The test is running correctly when:

- The 5V signature (A43 pin A38) reads 8708.

If the test is running correctly, check the signatures in Table 11-C-16 or 11-C-17.

**NOTE**

*There are two sets of signatures for the ROM Data Test depending on which revision of ROM's your instrument contains. To identify which set you have, check the part numbers on A43U3,4. If the numbers are 1818-0646B and 1818-0647B use the Revision B Data. If the numbers are 1818-0646C and 1818-0647C use the Revision C Data.*

**Table 11-C-15. ROM Address Latch Signatures**

Primary Signatures							
U9 Pin	Signature	U11 Pin	Signature	U12 Pin	Signature	U13 Pin	Signature
4	C690	2	FF4F	2	5P43	2	3P83
5	H3FF	6	5HC4	6	108P	6	PA7P
6	P732	10	OPOP	10	A7A2	10	F8C3
7	O566	14	OF62	14	4PCC	14	1H5P

Secondary Signatures					
U9 Pin		Signature	U10 Pin		Signature
1		0000	1		51A2
2		H6AA	7		655F
3		P254			

U11 Pin		Signature	U12 Pin		Signature	U13 Pin		Signature
1		4C44	1		H94C	1		C98C
7		HACF	7		9786	7		6H76
9		8906	9		20AA	9		4UCC
15		8C6A	15		F9C3	15		9A56

## Revision B ROM's

**(A43U3,4 Part Numbers 1818-0646B and 1818-0647B)**

Check the Primary Signatures in Table 11-C-16.

- a. If the signatures are correct, return to the Central Processor Troubleshooting Tree for further instructions.
- b. If the Primary Signatures are wrong, check the Secondary Signatures. If the Secondary Signatures are correct the Probable Defect is U14 or U15 depending on where the error was found. If the Secondary Signatures are also wrong, run the ROM Data Test (DSA Test 11-C-2-7) to find the erroneous ROM.

**Table 11-C-16. Revision B ROM's**

5V Signature = 8708  
 CLOCK . . . . . (out)

<b>Primary Signatures</b>			
<b>U14 Pin</b>	<b>Signature</b>	<b>U15 Pin</b>	<b>Signature</b>
1	F48F	1	F48F
3	3774	3	A2CF
5	P2UF	5	896U
7	0717	7	95PH
9	0F84	9	0401
11	3467	11	2H6H
13	7732	13	07H3
15	9338	15	C69F
17	P5H7	17	709F

<b>Secondary Signatures</b>			
2	C07F	2	25C4
4	65U4	4	FAPC
6	4493	6	H669
8	4U00	8	8309
12	C36U	12	AA65
14	U03A	14	80HC
16	HO CF	16	U518
18	A653	18	U794

## Revision C ROM's

**(A43U3,4 Part Numbers 1818-0646C and 1818-0647C)**

Check the Primary Signatures in Table 11-C-17.

- a. If the signatures are correct, return to the Central Processor Troubleshooting Tree for further instructions.
- b. If the Primary Signatures are wrong, check the Secondary Signatures. If the Secondary Signatures are correct the Probable Defect is U14 or U15 depending on where the error was found. If the Secondary Signatures are also wrong, run the ROM Data Test (DSA Test 11-C-2-7) to find the erroneous ROM.

**Table 11-C-17. Revision C ROM's**

5V Signature = 8708  
 CLOCK..... (out)

<b>Primary Signatures</b>			
<b>U14 Pin</b>	<b>Signature</b>	<b>U15 Pin</b>	<b>Signature</b>
1	F48F	1	F48F
3	U52P	3	80UF
5	109P	5	08FC
7	3H7C	7	89CO
9	P068	9	OU9A
11	4743	11	HHA6
13	28PA	13	60A3
15	6162	15	C160
17	CAAH	17	F011

<b>Secondary Signatures</b>			
2	7226	2	OAP0
4	9796	4	PU5C
6	7PUU	6	7A1P
8	A3PF	8	P7PO
12	F04C	12	UH65
14	AUP2	14	62F6
16	22P6	16	A130
18	U929	18	F663

# DSA Test No. 11-C-2-7 ROM Data Test

Turn the 3585A power off.

Areas Tested:

Individual ROM Output Data

Remove Boards:

A42

Place on PC Extender:

A43




Special instructions for this test:

A41J1 in the "Test" position  
Remove A43U16,17

Connect the Signature Analyzer as follows:

START and STOP .....	see note
CLOCK .....	A43TP5
GND .....	Chassis ground

Set the Signature Analyzer controls as follows:

START .....		(in)
STOP .....		(out)
CLOCK .....		(out)

Turn the 3585A power on.

### NOTE

*Each pair of ROM's (U1 and U2, U3 and U4, etc.) can be checked individually by connecting the START and STOP lines to the appropriate test point. TP1 is associated with ROM pair U1 and U2, TP2 with U3 and U4, etc. If you know which ROM pair is causing an error, connect to the correct test point to determine which ROM is causing the problem. To verify all the ROM data, start with U1(TP1) and check all signatures.*

The test is running correctly when:

- The 5V signature (A43 pin A38) reads  
20CP for START and STOP on TP1  
826P for START and STOP on TP2-4

Once the test is running correctly:

1. Check the signatures associated with the test point you are connected to, Table 11-C-18.

- a. If the signatures are correct, check the next set of signatures. Once all the signatures are checked, re-run the ROM checksum test.
- b. If a wrong signature appears, replace the associated ROM.

**Table 11-C-18. ROM Data Signatures**

START, STOP on TP1  
Testing U1 and U2  
5V Signature = 20CP  
Revision B and C ROM's

U1 Pin	Signature	U2 Pin	Signature
9	7ACA	9	75H5
10	F9U2	10	0874
11	8929	11	8174
13	7822	13	9755
14	F4PC	14	7UU4
15	5F30	15	2336
16	69PA	16	4835
17	8P7U	17	C390

START, STOP on TP2  
Testing U3 and U4  
5V Signature = 826P  
Revision B ROM's

Part Number 1818-0646B, -0647B

U3 Pin	Signature	U4 Pin	Signature
9	364P	9	140C
10	H869	10	4F41
11	03UA	11	66U2
13	U429	13	4H18
14	65FP	14	H330
15	4U50	15	A8H8
16	876H	16	HAC2
17	8290	17	3038

START, STOP on TP2  
Testing U3 and U4  
5V Signature = 826P

Revision C ROM's  
Part Number 1818-0646C, -0647C

U3 Pin	Signature	U4 Pin	Signature
9	P13A	9	6901
10	A8H4	10	4PH6
11	55AU	11	2P2H
13	3390	13	8179
14	17P4	14	U848
15	7812	15	F412
16	1591	16	83P3
17	OP8U	17	U4U8

START, STOP on TP3  
Testing U5 and U6  
5V Signature = 826P  
Revision B and C ROM's

U5 Pin	Signature	U6 Pin	Signature
9	5015	9	3FOP
10	H755	10	UHUC
11	P530	11	7A5U
13	HF76	13	2U8C
14	U1PO	14	5UCU
15	H27P	15	6A80
16	HH99	16	4641
17	UF13	17	93C1

START, STOP on TP4  
Testing U7 and U8  
5V Signature = 826P  
Revision B and C ROM's

U7 Pin	Signature	U8 Pin	Signature
9	8PA5	9	OCF9
10	OU2F	10	OHH4
11	C000	11	3120
13	P6UP	13	317H
14	2PAP	14	9301
15	86P4	15	C445
16	23P6	16	5PP2
17	FC29	17	7FP1

# DSA Test No. 11-C-3-1 I/O Data Output Test

Turn the 3585A power off.

Areas Tested:

A63 (Display Processor)

### NOTE

*Part A of this test is used as a generalized keyboard diagnostic tool. It is used in conjunction with the Central Processor Troubleshooting Tree.*

*Part B of this test is a specialized tool to check the output buffers on the I/O Board. This part of the test is used when you have been directed to the I/O Board Service Group from another Service Group. To check the data coming out of the I/O Board: 1) find the appropriate section (i.e. if you were sent here by the IF or Video Filter Troubleshooting Trees then go to the pages containing the IF/Video Filter Signatures); 2) check the Primary Signatures (outputs); 3) if the signatures are OK the problem is occurring in the cabling or on the board you were sent from; and 4) if the signatures are incorrect, check the Secondary Signatures to pinpoint the problem on the A45 board.*

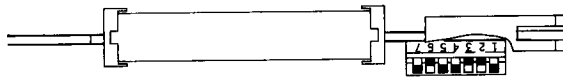
Remove Boards:

If a board is suspected of loading down the I/O Board, remove it and check for a change in the output signatures.

Place on PC Extender:

A45 (I/O)

Set A45 Test Switch to:



(Black indicates switch position)

Connect the Signature Analyzer as follows:

START and STOP.....A45TP1  
CLOCK ..... A45TP2  
GND....."GND" test point

Set the Signature Analyzer controls as follows:

START ..... (out)  
STOP ..... (in)  
CLOCK ..... (out)

Turn the 3585A power on.

The test is running correctly when:

- All front panel LED's are flashing except "overload".
- The 5V signature (A45 pin A38) reads C2HH.

If the test is running correctly, do the following:

**Part A**

Return to the Central Processor Troubleshooting Tree for further instructions.

**Part B**

Find the appropriate section and check the signatures.

If the test is running incorrectly:

1. If the 5V signature is wrong the I/O Control Bus may not be outputting the correct signals; therefore, run the Processor I/O Control Test (DSA Test 11-C-1-4) to check the I/O Control Lines and the IOD Bus.

**IF/Video Filter**

1. Check the Primary signatures (Table 11-C-19).
  - a. If correct, the information being sent to the IF/Video Filter boards is correct at the A45 board output. Check the cable connecting A45 and A34 if problems persist.
  - b. If incorrect, go to step 2.
2. Check the Secondary Signatures using the schematic and Table 11-C-20.
  - a. If correct, replace the defective part as indicated by the defective signature.
  - b. If the input signatures are wrong, go to the "IOA Bus" section of this DSA test to find the problem.

**Table 11-C-19. IF/Video filter - Primary Signatures**

U34 Pin	Signature	U5 Pin	Signature
2	A14U	5	68U1
4	U429	9	873H
6	4P86		
8	1430		
10	0593		
12	PF5F		

**Table 11-C-20. IF/Video Filter - Secondary Signatures**

Outputs		Inputs		Outputs		Inputs	
U13 Pin	Signature	U13 Pin	Signature	U22 Pin	Signature	U22 Pin	Signature
2	1392	3	56F5	9	F53C	1	C2HH
5	46U4	4	5U2H	10	35PO	2	A1U9
7	UFSC	6	1F17	11	HA2F	3	9H2U
10	A6PH	11	U406	12	6H45	13	1680
12	C74P	13	23PF			14	U56U
15	5P81	14	79C5			15	0000



**Local Oscillator**

1. Check the Primary Signatures (Table 11-C-21).
  - a. If correct, the information being sent to the LO Control Board (A34) by the A45 Board is correct. Check the cable connecting A45 and A34 if problems persist.
  - b. If incorrect go to step 2.
2. Check the Secondary Signatures using the schematic and Table 11-C-22.
  - a. If correct, replace the defective part as indicated by the defective signature.
  - b. If the input signatures are wrong, go to the "IOD Bus" section of this DSA test to find the problem.

**Table 11-C-21. Local Oscillator - Primary Signatures**

U14 Pin	Signature	U22 Pin	Signature
2	OCHO	5	27CF
5	55P4	6	F1HU
7	P6PU		
10	A030		
12	810F		

**Table 11-C-22. Local Oscillator - Secondary Signatures**

Inputs		Outputs		Inputs	
U14 Pin	Signature	U22 Pin	Signature	U22 Pin	Signature
3	OOPP	4	7P1C	1	C2HH
4	FA93			2	A1U9
6	5F9U			3	9H2U
1	C2HH			13	1680
13	871H			14	U56U
				15	0000

**Input Section**

1. Check the Primary Signatures (Table 11-C-23).
  - a. If correct, the information being sent to the Input Board is correct at the outputs of the A45 Board.
  - b. If incorrect, go to step 2.
2. Check the Secondary Signatures using the schematic and Table 11-C-24.
  - a. If correct, replace the defective part as indicated by the defective signature.
  - b. If the input signatures are wrong, go to the "IOD Bus" section of this DSA test to find the problem.

**Table 11-C-23. Input Section - Primary Signatures**

U11 Pin	Signature	U4 Pin	Signature
2	4H34	9	1U93
5	4F4U		
7	5CUA		
10	20A7		
12	957A		
15	F8A1		

**Table 11-C-24. Input Section - Secondary Signatures**

Inputs	
U11 Pin	Signature
3	5U2H
4	56F5
6	3216
11	311F
13	27C4
14	63UA

Outputs		Inputs		Inputs	
U20 Pin	Signature	U20 Pin	Signature	U4 Pin	Signature
4	F633	1	C2HH	12	871H
9	8U51	2	2UP2		
		3	9H2U		
		13	1680		
		14	PP18		
		15	0000		

**Tracking Generator**

1. Check the Primary Signatures (Table 11-C-25).
  - a. If correct, the information being sent to the Tracking Generator Board is correct at the output of the A45 Board.
  - b. If incorrect, go to step 2.
2. Check the Secondary Signatures using the schematic and Table 11-C-26.
  - a. If correct, replace the defective part as indicated by the defective signature.
  - b. If the input signatures are wrong, go to the "IOD Bus" section of this DSA test to find the problem.

**Table 11-C-25. Tracking Generator - Primary Signatures**

U12 Pin	Signature	U20 Pin	Signature
2	H8AU	10	F9F5
5	15UF	11	44PH
7	FOFH		
10	93HA		
12	A2A6		
15	C560		

**Table 11-C-26. Tracking Generator - Secondary Signatures**

Inputs		Outputs		Inputs	
U12 Pin	Signature	U20 Pin	Signature	U20 Pin	Signature
3	871H	12	5PCF	1	C2HH
4	C2CA			2	2UP2
6	5F9U			3	9H20
11	FA93			13	1680
13	OOPP			14	PP18
14	187F			15	0000

**Keyboard**

1. Check the Primary Signatures (Table 11-C-27).
  - a. If correct, the information being sent to the Keyboard is correct at the output of the A45 Board.
  - b. If incorrect, go to step 2.
2. Check the Secondary Signatures using the schematic and Table 11-C-28.
  - a. If correct, replace the defective part as indicated by the defective signature.
  - b. If the input signatures are wrong, go to the "IOD Bus" section of this DSA test to find the problem.

**Table 11-C-27. Keyboard - Primary Signatures**

U17 Pin	Signature	U21	Signature
2	AHOA	10	PA2U
5	H320	11	U29P
6	34F2		
9	3ACF		
12	6A5C		
15	HU55		
16	8405		
19	61CO		

U33 Pin	Signature	U1 Pin	Signature
2	C2HH	9	C1PU
8	3UA9		

**Table 11-C-28. Keyboard - Secondary Signatures**

Inputs		Outputs	
U17 Pin	Signature	U21 Pin	Signature
3	23PF	4	FH8U
4	79C5	5	8H74
7	187F	12	325A
8	00PP		
13	FA93		
14	5F9U		
17	C2CA		
18	871H		



**Inputs**

U21 Pin	Signature	U33 Pin	Signature	U1 Pin	Signature
1	C2HH	1	0000	12	63UA
2	6218				
3	9H2U				
13	1680				
14	2APC				
15	0000				

**Display**

1. Check the Primary Signatures (Table 11-C-29).
  - a. If correct, the information being sent to the Display Board is correct at the output of the A45 Board.
  - b. If incorrect, go to step 2.
2. Check the Secondary Signatures using the schematic and Table 11-C-30.
  - a. If correct, replace the defective part as indicated by the defective signature.
  - b. If the input signatures are wrong, go to the "IOD Bus" section of this DSA test to find the problem.

**Table 11-C-29. Display - Primary Signatures**

<b>NOTE</b>							
<i>The Display Processor Board (A63) must be removed to obtain the correct signatures for this test.</i>							
U15 Pin	Signature	U16 Pin	Signature	U24 Pin	Signature	U3 Pin	Signature
2	H69U	2	2UC1	10	F5FF	6	6CC3
5	F423	5	A0A0		(CLK  )		(CLK  )
6	4P19	6	3340				
9	P600	9	H16U				
12	9F81	12	045F				
15	7C29	15	79C5				
16	HPU8	16	FP6C				
19	641U	19	H516				

**Table 11-C-30. Display -Secondary Signatures**

U15 Pin	Signature	U16 Pin	Signature	U3 Pin	Signature	U4 Pin	Signature
3	63UA	3	23PF	1	C2HH	3	0000
4	27C4	4	79C5	3	C2HH	4	7FC6
7	311F	7	187F	4	67FC	5	7711
8	3216	8	00PP	5	C2HH		
13	56F5	13	FA93	6	0000		
14	5U2H	14	5F9U	9	C2HH		
17	1F17	17	C2CA	10	0000		
18	U406	18	871H				

U23 Pin	Signature	U24 Pin	Signature	U9 Pin	Signature
2	0000	1	3A40	2	C2HH
12	C2CA	2	6CC3	3	0000
		3	P32P (CLK $\swarrow$ )	4	C2HH
				5	7111
				6	F5FF

**IOD Bus**

This test will allow you to check the validity of the data entering the I/O Board (A45) from the Processor Board (A41). To use this test, check the Primary Signatures first. If the Primary signatures are correct, go on to check the Secondary Signatures. If the Primary Signatures are incorrect, check the following:

<u>Incorrect Signatures</u>	<u>Action</u>
IOD Bus or I/O Control	Remove the I/O Board and run the Processor I/O control test (DSA Test 11-C-1-4). Check the signatures associated with the test. If correct, the IOD Bus is being loaded down by something on the A45 Board. If incorrect, replace the faulty component.
I/O Status	Use the Secondary Signatures and the schematic to find the faulty component. Determine which line is faulty and use the schematic to determine which signatures to check.

**Table 11-C-31. IOD Bus - Primary Signatures**

IOD Bus		
Line Name	A45 Pin	Signature
LIOD 0	B21	871H
LIOD 1	A21	C2CA
LIOD 2	B22	5F9U
LIOD 3	A22	FA93
LIOD 4	B23	00PP
LIOD 5	A23	187F
LIOD 6	B24	79C5
LIOD 7	A24	23PF
LIOD 8	B25	U406
LIOD 9	A25	1F17
LIOD 10	B26	5U2H
LIOD 11	A26	56F5
LIOD 12	B27	3216
LIOD 13	A27	311F
LIOD 14	B28	27C4
LIOD 15	A28	63UA

I/O Control		
Line Name	A45 Pin	Signature
LPA 0	B33	13F8
LPA 1	A33	A636
LPA 2	B34	6661
LPA 3	A34	290P
LINT	A32	C2HH
LIO SB	B32	C2HH
LDOUT	A31	0001
LIC 1	A35	1680
LIC 2	B35	9H2U

I/O Status		
Line Name	A45 Pin	Signature
LIRL	A30	0000
LIRH	B30	C2HH
LDMAR	B31	F5FF
LFLG	A29	0H89
LSTS	B29	C2HH
LRESET	A36	*C2HH
LINIT	B36	C2HH

\* Changable with an Instrument Preset.

**Table 11-C-32. IOD Bus - Secondary Signatures**

I/O Control Decoder		
Line Name	U19 Pin	Signature
LSC 00	7	C2HF
LSC 01	9	H96P
LSC 02	10	2UP2
LSC 03	11	U56U
LSC 04	12	PP18
LSC 05	13	4268
LSC 06	14	2APC

Line Name	U18 Pin	Signature
LSC 10	7	6218
LSC 12	10	51U3
LSC 13	11	C8U4
LSC 16	14	A1U9
LSC 17	15	C2H9

I/O Control Peripheral Devices					
U1 Pin	Signature	U2 Pin	Signature	U7 Pin	Signature
2	0000	1,13	C8U4	12*	0000
3	C2HF	6	C2HH	13	0A29
5	C2HH	9	0000		
		11	0000		

U9 Pin	Signature	U10 Pin	Signature	U23 Pin	Signature
8	C2HH	8	U9P7	3	P580
9	0A29	9	U9P7	4	C2HH
				5*	0000
				6*	C2HH
				8	FA93
				9	0000
				10	9CH3
				11*	0000

U25 Pin	Signature	U26 Pin	Signature	U36 Pin	Signature
1	P580	1	5FF5	2	0A29
10	575H	10	C8U4	4	1324
13	U9P7	13	0A29		

\*With J2 removed.

## DSA Test No. 11-C-3-2 CRT Test Pattern

Turn the 3585A power off.

Areas Tested:

IOD Bus  
I/O Control  
Low Level Interrupt  
DMA Request

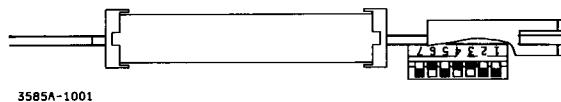
Remove Boards:

NA

Place on PC Extender:

A45

Set A45 Test Switch to:



(Black indicates switch position)

Connect the Signature Analyzer as follows:

START and STOP .....	A45TP1
CLOCK .....	A45TP2
GND .....	Chassis Ground

Set the Signature Analyzer controls as follows:

START .....				(out)
STOP .....				(in)
CLOCK .....				(in)

Turn the 3585A power on.

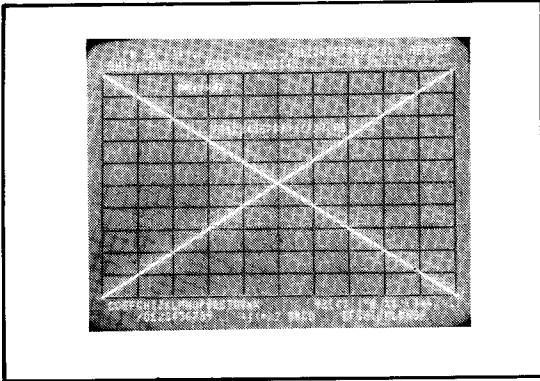
The test is running correctly when:

- The 5V signature (A45 pin A38) reads 29UP.

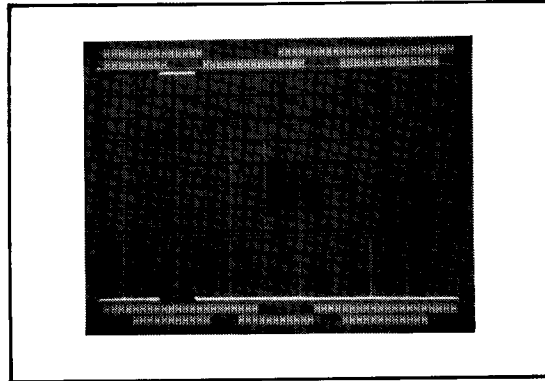
If the test is running correctly, do the following:

1. Check the CRT Display it should look like Figure 11-C-5.
  - a. If the CRT Display is correct, return to the Central Processor Troubleshooting Tree for further instructions.
  - b. If the CRT Display is incorrect, move A63J3 to the "Test" position. Go to step 2.
2. With A63J3 in the "Test" position the CRT display should resemble Figure 11-C-6.





**Figure 11-C-5. CRT Test Pattern  
(Central Processor Controlled)**



**Figure 11-C-6. CRT Test Pattern  
(Display Processor Controlled)**

- a. If the CRT Test Pattern now resembles Figure 11-C-6 the CRT Display section is working correctly. The Probable Defect is on the I/O Board (A45) with some possibility of the Data Latches (A63U41,42) on the Display Processor Board (A63, Service Group 11-D-2-3) being defective. To check the I/O Board, go to step 3.
  - b. If the CRT Test Pattern does not resemble Figure 11-C-6, momentarily move A63J1 to the "Test" position, then back to the "Normal" position. If the CRT still does not resemble Figure 11-C-6 go to the Display Troubleshooting (Service Group D).
3. Put A63J3 back in the "Normal" position.
  4. Check the CRT Test Pattern Primary Signatures, Table 11-C-33.
    - a. If the signatures are correct, the Probable Defect is in the Display section, Service Group 11-D-2-3.
    - b. If the signatures designated as "Interrupt Request" are correct, but the "Display Data" signatures are wrong; the Probable Defect is U15,16. Check the Secondary Signatures (Table 11-C-34) for these devices to confirm the failure. If the Secondary Signatures are wrong run DSA Test 11-C-1-4.
    - c. If the "Interrupt Request" signatures are wrong run the DMA Request Circuitry Test (DMA Test 11-C-3-3) and the Low Level Interrupt Test (DMA Test 11-C-3-4). These tests will show whether the problem is occurring on the I/O Board (A45) or the Display Processor Board (A63).

If the test is running incorrectly:

1. Momentarily short the A41 boards LRESET pin to the pin next to it.
2. If the 5V signature is still wrong, run the Processor I/O Control Test (DSA Test 11-C-1-4). There is also the possibility that the A45 test switch or A45U30 are not working correctly. If the I/O control test passes, go to the DMA Request Circuitry Test (DSA Test 11-C-3-3).

#### NOTE

*The Central Processor (A41U13) contains input buffers for the IOD bus. If DSA Test 11-C-3-1 will run, but DSA Test 11-C-3-2 thru 11-C-3-4 will not run, A41U10,13 may be causing the problem.*

**Table 11-C-33. CRT Test Pattern - Primary Signatures**

**NOTE**

*If pins are accidentally shorted during this test it may stop the test program. This is usually indicated by an incorrect 5V signature, an extinguished "gating" light on the Signature Analyzer or a blank display (if the display was previously working). To get the test running again, short A41 LRESET to the pin next to it for about one second.*

**Interrupt Request**

U3 Pin	Signature	U6 Pin	Signature	U24 Pin	Signature
4	29UP	8	29UP	10	0002
6	29UF	9,12	0000		

**Display Data**

U16 Pin	Signature	U15 Pin	Signature
2	941F	2	CU78
5	HC40	5	447C
6	83HA	6	0C71
9	1426	9	3189
12	C13C	12	6PH3
15	7668	15	1562
16	69FP	16	87PP
19	1H2F	19	AF44

**Table 11-C-34. CRT Test Pattern - Secondary Signatures**

**NOTE**

*Change the Signature Analyzer controls to:*

*CLOCK ..... (out)*

U16 Pin	Signature	U15 Pin	Signature	U24 Pin	Signature
3	523A	3	7PU1	1,8	0001
4	FF83	4	88U6	2,13	0002
7	7HC6	7	16P2	3,4,9	29UH
8	524U	8	6312	5	0003
11	0001	13	A7A5	6	0000
13	1874	14	50F7	11	0000
14	96H3	17	75HP	12	29UF
17	A99P	18	228A		
18	405C				

# DSA Test No. 11-C-3-3 DMA Request Circuitry Test

Turn the 3585A power off.

Areas Tested:

LDMARQ and LDMARF lines and associated circuitry on the I/O Board.

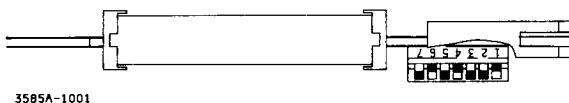
Remove Boards:

A63 (Display Processor)

Place on PC Extender:

A45

Set A45 Test Switch to:



(Black indicates switch position)

Connect the Signature Analyzer as follows:

START and STOP .....	A45TP1
CLOCK .....	A45TP2
GND .....	Chassis Ground

Set the Signature Analyzer controls as follows:

START .....		(out)
STOP .....		(out)
CLOCK .....		(out)

Turn the 3585A power on.

The test is running correctly when:

- The 5V signature (A45 pin A38) reads P733.
- The beeper "clicks".

If the test is running correctly:

The DMA Request Circuitry is operating correctly on the A45 Board. Go to the Low Level Interrupt Test (DMA Test 11-C-3-4) to check the remainder of the Interrupt Circuitry.

If the test is running incorrectly:

Go to the I/O Data Output Test (DSA Test 11-C-3-1) and run the "Display" section of the test. Using the schematic and the Secondary Signatures (Display Board removed) to find the problem in the DMA Request Circuit consisting of U4,6,24. Also check A63 LDMARQ with A63J1 in the Test position.

# DSA Test No. 11-C-3-4 Low Level Interrupt (LDMAIR) Test

Turn the 3585A power off.

Areas Tested:

LDMAIR Line

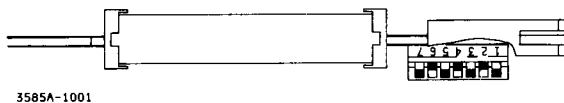
Remove Boards:

A63

Place on PC Extender:

A45

Set A45 Test Switch to:






(Black indicates switch position)

Connect the Signature Analyzer as follows:

START and STOP .....	A45TP1
CLOCK .....	A45TP2
GND .....	Chassis Ground

Set the signature Analyzer controls as follows:

START .....		(out)
STOP .....		(out)
CLOCK .....		(out)

Turn the 3585A power on.

The test is running correctly when:

- The 5V signature (A45 pin A38) reads 7339.
- The beeper "clicks".

If the test is running correctly:

The Display Processor DMA Interrupt Line is working correctly. Check A63 LDMAIR with A63J1 in the Test position. Return to the CRT Test Pattern (DSA Test 11-C-3-2).

If the test is running incorrectly:

1. Run the Processor Self Test (DSA Test 11-C-1-2).
2. If the Processor Self Test passes the Probable Defect is A45U3,6,9 or A41U10.
3. If the test will still not run after replacing the above components, the Probable Defect is the ROM (DSA Test 11-C-2-1) or the Processor (A41U13).

# DSA Test No. 11-C-3-5 High Level Interrupt (HADIR) Test

Turn the 3585A power off.

Areas Tested:

HADIR Line

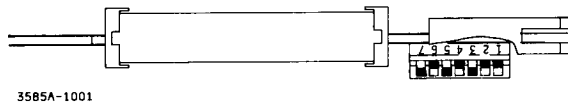
Remove Boards:

A63

Place on PC Extender:

A45

Set A45 Test Switch to:



(Black indicates switch position)

Connect the Signature Analyzer as follows:

- START and STOP ..... A45TP1
- CLOCK ..... A45TP2
- GND ..... Chassis Ground

Set the Signature Analyzer controls as follows:

- START ..... (out)
- STOP ..... (out)
- CLOCK ..... (out)

Turn the 3585A power on.

Short A45J2 pin A1 to A45J2 pin B6.

The test is running correctly when:

- The 5V signature (A45 pin A38) reads 5456.
- The beeper "clicks" (does not beep).

If the test is running correctly:

The I/O Board portion of the High Level Interrupt Circuit is working correctly. You may return to the test which called out this routine.

If the test is running incorrectly:

1. The beeper will beep.
2. The Probable Defect is A45U2,26,7,23. Run the IOD Bus - Secondary Signatures portion of the I/O Data Test (DSA Test 11-C-3-1) to check these devices. If all the signatures check good, run the ROM Checksum Test (DSA Test 11-C-2-1). If that test also passes the Probable Defect is A41U10,13.

# DSA Test No. 11-C-4-1 Keyboard Test

Turn the 3585A power off.

Areas Tested:

Keyboard Keys

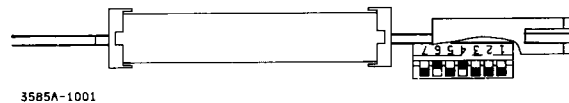
Remove Boards:

NA

Place on PC Extender:

A45

Set the A45 Test Switch to:



(Black indicates switch position)

Connect the Signature Analyzer as follows:

START and STOP . . . . .	A45TP1
CLOCK . . . . .	A45TP2
GND . . . . .	A45"GND"

Set the Signature Analyzer controls as follows:

START . . . . .	(out)
STOP . . . . .	(in)
CLOCK . . . . .	(out)

Turn the 3585A power on.

The test is running correctly when:

- The A45 Board LED blinks about four times per second.

If the test is running correctly:

1. Does the 5V signature read 3865.
  - a. If it does, no keys are stuck down. Go on to step 2.
  - b. If the signature does not read 3865, go to step 3.
  - c. If several keys are not responding, or all keys are not responding during normal operation go to step 4.
2. To check the operation of any key individually (particularly if you suspect a problem with one key) use Table 11-C-35. Hold the key down to check its signature. To check the I/O keyboard buffers for correct operation, see Table 11-C-36.

- a. If the correct signature appears when a key is pressed, that key is operating correctly. If the key responds correctly but the LED will not light (or extinguish), go to DSA Test 11-D-4-2.
  - b. If the signature does not change or is incorrect when the key is pressed the key is probably faulty. Go to the Keyboard Key Replacement section for further instructions.
3. A key is probably stuck down, check Table 11-C-35 for a matching signature.
    - a. If a matching signature is found, check the mechanical operation of the stuck key. If the key continues to cause problems go to the Key Replacement section of this test and replace the key.
    - b. If a matching signature is not found, two or more keys may be stuck. Make a careful visual inspection of the keyboard and try to pull out any stuck keys, then recheck Table 11-C-35. If no stuck keys are found, go to step 4

**Table 11-C-35. Front Panel Switch Signatures**

All signatures on +5 V - Must hold key down to read signature. No Keys Down = 3865					
Key	Signatures	Switch Number	Key	Signatures	Switch Number
CENTER FREQUENCY	U2F9	S1	VIEW B	C1CA	S36
FREQUENCY SPAN	U964	S2	MAX HOLD	H8HH	S37
START FREQ	7FC2	S3	CLEAR	6F6P	S38
STOP FREQ	CP59	S4	OFS → SPAN	C637	S39
CF STEP SIZE	5U2F	S5	MKR → CF	5C1C	S40
REF LEVEL LOG	AU96	S6	DOWN	2H8H	S41
dB/DIV	H7FC	S7	UP	96F6	S42
REF LVL VOLTS	PCP5	S8	SAVE	4C63	S43
RES BW	75U2	S9	RECALL	A5C1	S44
VIDEO BW	CAU9	S10	FULL SWEEP	H2H8	S45
SWEEP TIME	HH7F	S11	MINUS	696F	S46
RANGE	6PCP	S12	DECIMAL	C4C6	S47
MHz/dBm/V	C75U	S13	LOCAL	HA5C	S48
kHz/dBV/μV	5CAU	S14	0	6H2H	S49
Hz/dB/μV	AHH7	S15	1	3696	S50
SEC	H6PC	S16	2	1C4C	S51
COUPLED TO SPAN	PC75	S17	3	OHA5	S52
PRESET	U5CA	S18	4	86H2	S53
RES BW HOLD	UAHH	S19	5	F369	S54
50Ω	UH6P	S20	6	P1C4	S55
75Ω	7PC7	S21	7	70HA	S56
1MΩ	CU5C	S22	8	C86H	S57
AUTO RANGE	5UAH	S23	9	HF36	S58
REF LVL TRACK	AUH6	S24	CONT SWEEP	6P1C	S59
OFFSET	H7PC	S25	SINGLE SWEEP	C70H	S60
MARKER	PCU5	S26	MANUAL ENTRY	5C86	S61
A-B	75UA	S27	FREE RUN	2HF3	S62
REF LVL	CAUH	S28	EXT TRIGGER	FC70	S63
DSPL LINE	HH7P	S29	LINE TRIGGER	96P1	S64
OFF	6PCU	S30	MRK/OFS → STEP	65C8	S65
MKR → REF LVL	375U	S31	COUNTER	32HF	S66
NOISE LVL	1CAU	S32	ENTER OFFSET	196P	S67
CLEAR A	8HH7	S33	CF	OFC7	S68
STORE A → B	F6PC	S34	MAN SWEEP	865C	S69
VIEW A	6375	S35	INSTR PRESET		S70

**Table 11-C-36. Keyboard I/O Buffer Check**

Ref Level Volt	PCP5
Hz/dB/ $\mu$ V	AHH7
1M $\Omega$	CU5C
Dspl Line	HH7P
View B	C1CA
Save (off)	4C63
1	3696
8	C86H
Counter	32HF

4. Several possibilities exists for this condition. Either one key is always stuck down, which should result in a matching signature in Table 11-C-35. If no match exists in Table 11-C-25 then the defect is probably in A45U17,U21,U27,U29,U10 or A47U11,U12.
5. Check Table 11-C-37, with a logic probe in the following manner. Each point should be high with no keys pressed. Each point should pulse when the recommended key is pressed.

**Table 11-C-37. Keyboard Matrix Output Line Test**

<i>Starting Condition - A45U17(11) pulsing. If it is not the Probable Defect is A45U21.</i>	
<b>To Check:</b>	<b>Press</b>
<b>A45U27 Pin</b>	
14	Ref Level Volt Hz/dB/ $\mu$ V 1M $\Omega$ Dspl Line View B Save (off)
12	
10	
6	
4	
2	
<b>A45U19 Pin</b>	
14	1
12	8
10	Counter

- a. If each pin on U27 and 29 checks good then the Probable Defect is U27 or U29. To isolate the problem return the instrument to normal operation and note which keys are not functioning or which keys the display shows as activated. Compare this information with that in Table 11-C-38.
- b. If one of the pins on U27,29 checks bad, go to step 6.
6. Check the outputs of A45U17 (2,5,6,9,12,15,16,19). All the outputs should cause the logic probe to flash.
  - a. If all the output pins of U17 cause the logic probe to flash, the Probable Defect is A47U11,12. Use the pin number which was incorrect on step 5 and Table 11-C-37 to isolate the problem to U11 or U12.
  - b. If one or more of the outputs do not cause the logic probe to flash then replace A45U17.



**Table 11-C-38. Keyboard Matrix**

A47	U11(3) LROW 0	Mkr-Ofs → Step	8	0	Step ↓	Clear A	Offset	Coupled To Span	Res BW	Center Frequency
	U11(6) LROW 1	Counter	9	1	Step ↑	Store A – B	Marker	Preset	Video BW	Frequency Span
	U11(8) LROW 2	Enter Offset	Cont Sweep	2	Save	View A	A-B	Res BW Hold	Sweep Time	Start Frequency
	U11(11) LROW 3	Single CF	Sweep	3	Recall	View B	Ref Lvl	50Ω	Range	Stop Frequency
	U12(3) LROW 4	Manual	Manual Entry	4	Full Sweep	Max Hold	Dspl Line	75Ω	MHz/dBm/V	CF Step Size
	U12(6) LROW 5		Free Run	5	– (minus)	Clear	Off	1MΩ	kHz/dBV/mV	Reference Level
	U12(8) LROW 6		Ext Trigger	6	(decimal)	Offset → Span	Mkr → Ref Lvl	Auto Range	Hz/dB/μV	dB/Div
	U12(11) LROW 7		Line Trigger	7	Local	Mkr → CF	Noise Lvl	Ref Level Track	Sec	Ref Lvl Volt
		U27(14) LCOL 0	U27(12) LCOL 1	U27(10) LCOL 2	U27(6) LCOL 3	U27(4) LCOL 4	U27(2) LCOL 5	U29(14) LCOL 6	U29(12) LCOL 7	U29(10) LCOL 8

A45

# DSA TEST NO. 11-C-4-2 KEYBOARD LED TEST

Turn the 3585A power off.

Areas Tested:

A47 LED's and Latches.

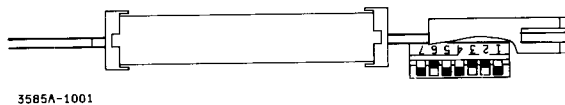
Remove Boards:

A47 (see the Keyboard LED Replacement Procedure). Only remove this PC board if an LED is faulty.

Place on PC Extender:

NA

Set A45 Test Switch to:



(Black indicates switch position)

Connect the Signature Analyzer as follows:

START and STOP .....	A45TP1
CLOCK .....	A45TP2
GND .....	A45 "GND" tet point

Set the Signature Analyzer controls as follows:

START .....	(out)
STOP .....	(in)
CLOCK .....	(out)

Turn the 3585A on.

The test is running correctly when:

- The 5V signature reads C2HH.

If the test is running correctly:

1. Check the LED's. Each LED (except OVERLOAD) should be blinking on and off.
  - a. If all the LED's are blinking on and off the LED's, excepting OVERLOAD, are working properly.
  - b. If one or more LED's are not blinking, go to step 2.
2. Swing the front panel away from the instrument so that the IC pins on the back of the board may be accessed. Check the Primary Signatures in Table 11-C-39.
  - a. If the Primary Signatures are correct, the defect is the LED which is not blinking. Go to the Keyboard LED Replacement procedure for complete LED replacement information.

- b. If the signature for U1(11) is incorrect, go to the Keyboard portion of DSA Test 11-C-3-1.
  - c. If the Primary Signatures are incorrect, go to step 3.
3. Check the Secondary Signatures, Table 11-C-40.
- a. If the Secondary Signatures are correct the probable defect is U1-4. Use the schematic and the incorrect signature from step 2 to locate the problem.
  - b. If all the Secondary Signatures are incorrect, go to the Keyboard portion of DSA Test 11-C-3-1. If the signatures for U5(1,2,8) are correct, the probable defect is A47U5-8. Use the schematic and the incorrect secondary signature information to locate the problem. Remember, data enter U5-8 in serial form. If the signatures for several of the shift register IC's are bad, always replace the one with the lowest number first (i.e., if U6,7 and 8 have bad signatures, replace U6 first).

**Table 11-C-39. Keyboard LED Test - Primary Signatures**

U1 Pin	Signature	U2 Pin	Signature	U3 Pin	Signature	U4 Pin	Signature
2	A521	2	580P	2	7P76	2	1920
5	F19C	5	9058	5	PC37	5	OHCU
6	A73F	6	U980	6	C880	6	7187
9	PACU	9	1750	9	4AH6	9	69C1
11	PA2U	12	43FF	12	ACP8	12	4945
12	1U69	15	A801	15	8P6F	15	348C
15	9F01	16	943A	16	UPOO	16	3A9F
16	P369	19	FHF1	19	7506	19	2519
19	36CC						

**Table 11-C-40. Keyboard LED Test - Secondary Signatures**

U1 Pin	Signature	U2 Pin	Signature
3	3344	3	P10C
4	HFCA	4	69U5
7	8F36	7	5HU4
8	U2PU	8	CP69
13	58U8	13	4A54
14	35P3	14	0833
17	4UFC	17	17CU
18	712U	18	F14U

U3 Pin	Signature	U4 Pin	Signature	U5 Pin	Signature
3	UC47	3	UACF	1	C1PU
4	C5F4	4	5UF4	8	U29P
7	8994	7	39U2		
8	UCC6	8	8169		
13	A280	13	255H		
14	3F1H	14	5417		
17	F019	17	A9H1		
18	HC35	18	922P		

**Keyboard Key Replacement Procedure**

- a. Turn the 3585A power off.
- b. Remove the instruments top cover.
- c. Remove the plastic trim strip from the top of the front frame.
- d. There are five screws under the trim strip, remove the first, third and fifth screw.
- e. The front panel is now loose. To remove it, find the space between the CRT shield and the cover marked "A11". Between these two items there is a space which allows access to the rear of the front panel. By applying gentle pressure to the rear of the front panel, the top of the front panel will swing out.
- f. Once the top edge of the front panel has swung away from the front frame it may be lifted out of the groove in which it sits.
- g. The front panel should now be free of the instrument except for a large ribbon cable.
- h. Remove the ribbon cable from the back of the keyboard.
- i. Set the keyboard face down on a soft, protected surface.
- j. Locate the round, black plastic housing for the knob. Disconnect the four wire cable from the PC board (A47J2).
- k. Remove the 12 screws which hold the PC board to the front panel.
- l. Place the keyboard (A47) face up on your work surface.
- m. Remove the key cap from the defective key. This requires a firm, straight pull. Do not pull at an angle as this can break part of the key off inside the key cap.
- n. Locate the defective key on the back side (trace side) of the PC board.
- o. While pulling on the body of the key, heat the plastic stakes on the back side of the PC board. This should allow removal of the key body.
- p. Clean off any excess plastic from the key mounting holes.
- q. Insert a new key.
- r. While holding the key from the keyboard side, *carefully* melt the plastic stake pins just enough to hold the key firmly in place. Note the degree that the other key stakes have been melted as a reference.
- s. Allow the key stake to cool and harden before testing the keys operation.
- t. Replace the key cap.
- u. Thread the cable from the knob housing through the large hole in the PC board and connect it to A47J2.
- v. Mount the keyboard (A47) to the front panel with the twelve mounting screws.
- w. Replace the ribbon cable in its socket and mount the front panel in the instrument.

**Keyboard LED Replacement.**

- a. Follow steps a. thru l. of the Keyboard Key Replacement Procedure.
- b. If one of the "external" LED's, such as the HP-IB status lights, is to be replaced, simply unsolder it and replace it with a new LED. (The cathode location is marked with a dot.) Pay careful attention to the vertical orientation of the LED when installing a new one. Check the alignment with the front panel and adjust as necessary.
- c. If one of the LED's in a key is to be replaced, remove the key cap of the faulty LED. This requires a firm, straight pull. Do not pull at an angle as this can break part of the key off inside the key cap.
- d. Turn the board over and unsolder the leads of the LED with a desoldering tool. Be careful not to melt the plastic stake which holds the key to the board.
- e. Return the PC board to a face up position.
- f. With a small pair of tweezers reach down inside the white portion of the key and remove the LED.
- g. Again using the desoldering tool, clean out any remaining solder in the holes for the LED.
- h. Using the back side of the PC board, shape the leads of the LED so that it will fit properly.
- i. Using the tweezers, insert the LED into its proper location with the cathode (marked lead) toward the *top* of the PC board. Be sure the LED is fully seated on the PC board. If it is not, it can interfere with key operation.
- j. Solder the leads of the LED to the PC board. Again, be careful not to melt the plastic key stake.
- k. Follow steps t. thru w. of the Keyboard Key Replacement Procedure.

**"Knob" Troubleshooting Procedure**

This procedure will help locate "Knob" problems such as: 1) the marker will only move one direction; 2) the marker will not move at all; 3) the keyboard will not respond, but the marker can be moved or; 4) the marker is always at the left edge of the CRT.

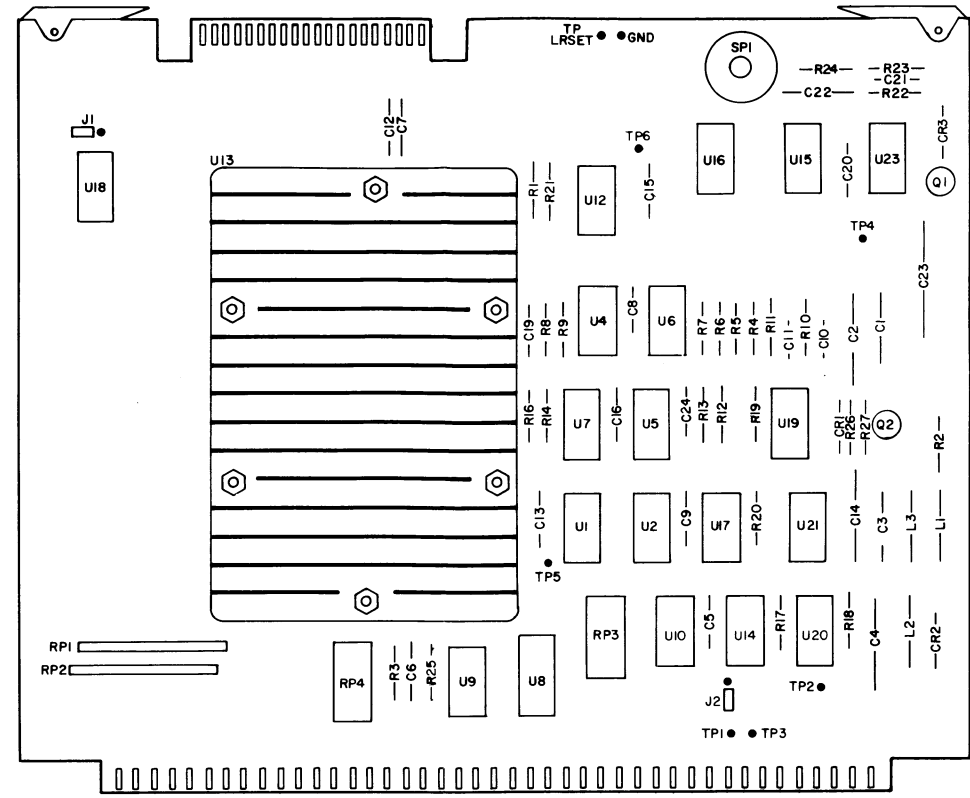
- a. Swing down the front panel, leaving the large ribbon cable connected. (See steps a. thru g. of the Keyboard Key Replacement Procedure for instruction on front panel removal.
- b. Remove the jumpers on A47W3,W4.
- c. Using a logic probe, check the pin closest to the top of the board (NORM) on W3 and W4.
  1. If the logic probe indicates pulses when the Knob is turned on the NORM pin of W3 and W4, go to step d.
  2. If the logic probe does not indicate pulses when the Knob is turned, the Probable Defect is the Knob assembly.
- d. Install the test jumpers for W3 and W4 in the "Test" position.
- e. Enter:

Man. Sweep On
- f. Using the logic probe, check for pulses at the following locations:

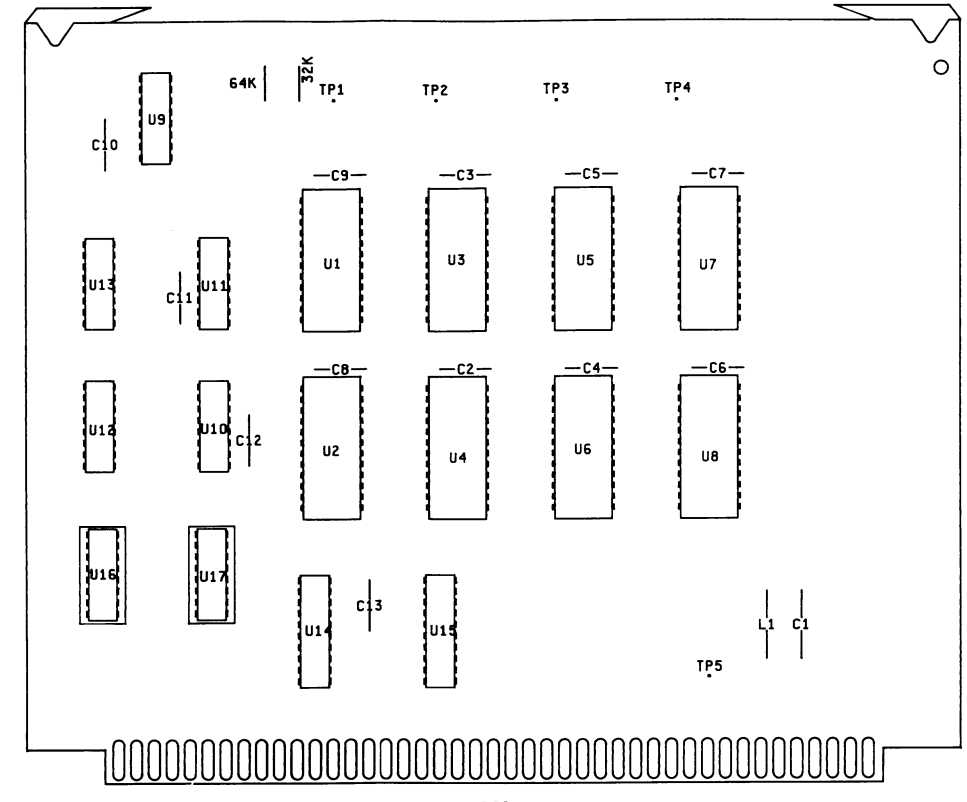
U9(5)  
U10(2,3,6,7)

  1. If there are pulses at all five locations, go to step g.
  2. If one of the pins is not pulsing, the Probable Defect is A47U9 or U10.
- g. Check for pulses at U10(14) with the logic probe.
  1. If U10(14) is pulsing, go to step h.
  2. If U10(14) is not pulsing, the Probable Defect is A45,U33,21. These devices may be checked with the Keyboard section of the I/O Data Output Test (DSA Test 11-C-3-1).
- h. Locate A45U29(1). This IC is accessible from the top with the board in the card nest. It is the IC\* under the ribbon cable from the keyboard. Check A45U29(1) for pulses.
  1. If A45U29(1) is pulsing, the Probable Defect is A45U29,31.
  2. If A45U29(1) is not pulsing, the Probable Defect is A45U10.

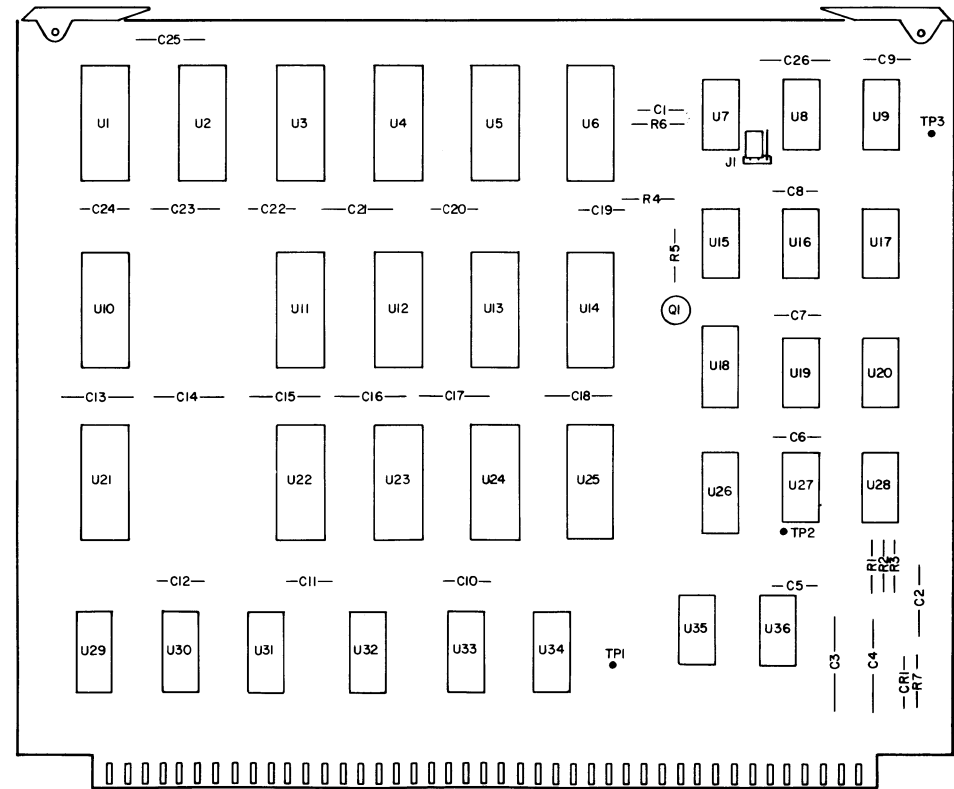
\*Nearest the rear of the instrument.



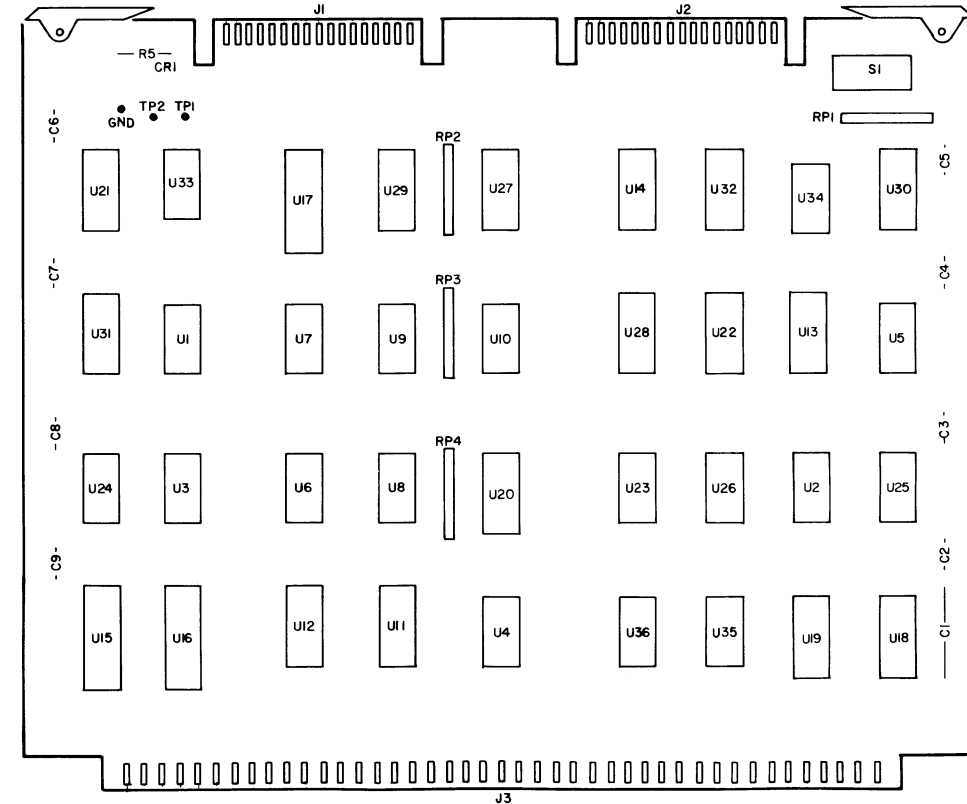
A41  
03585-66541



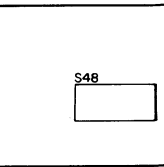
A43  
03585-66543



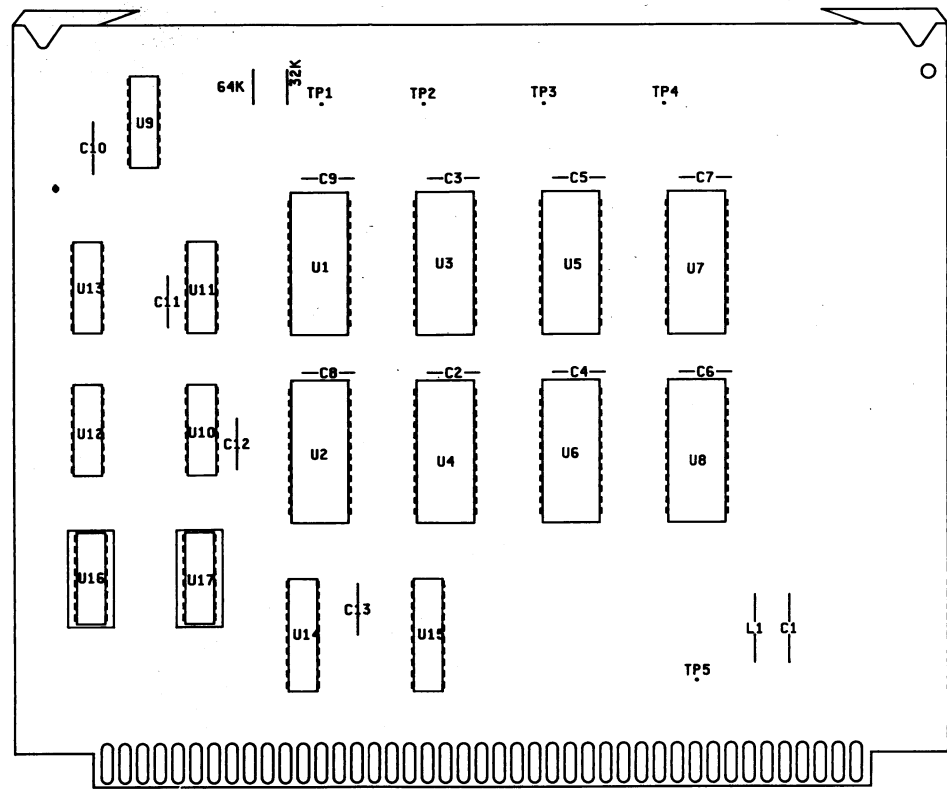
A42  
03585-66542



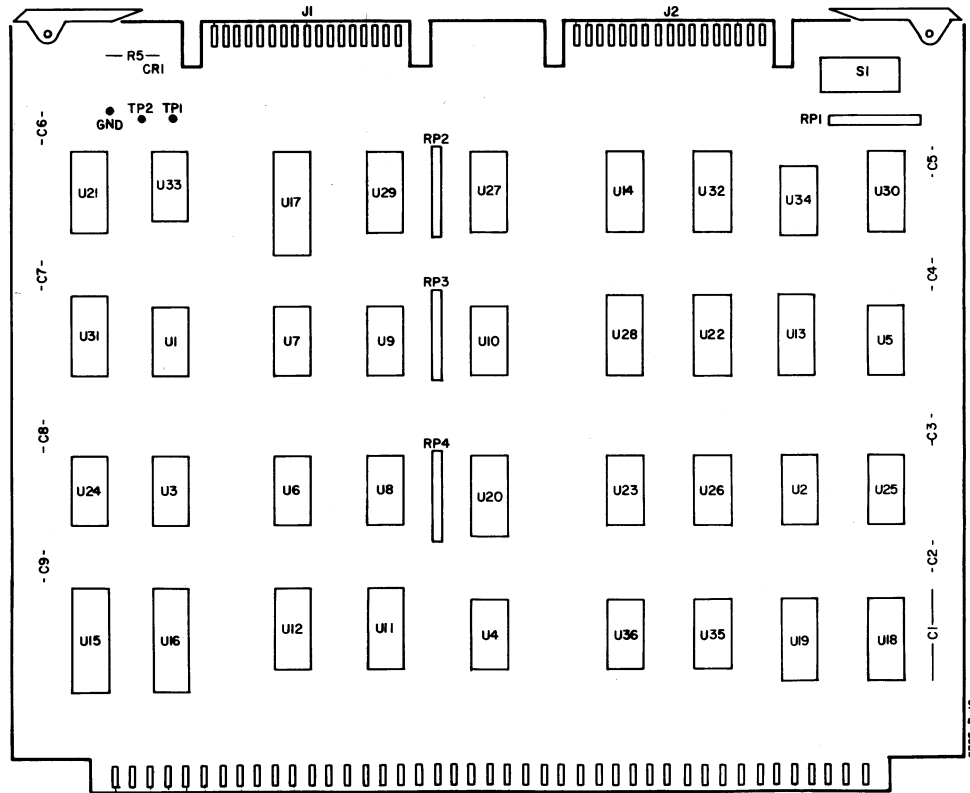
A45  
03585-66545



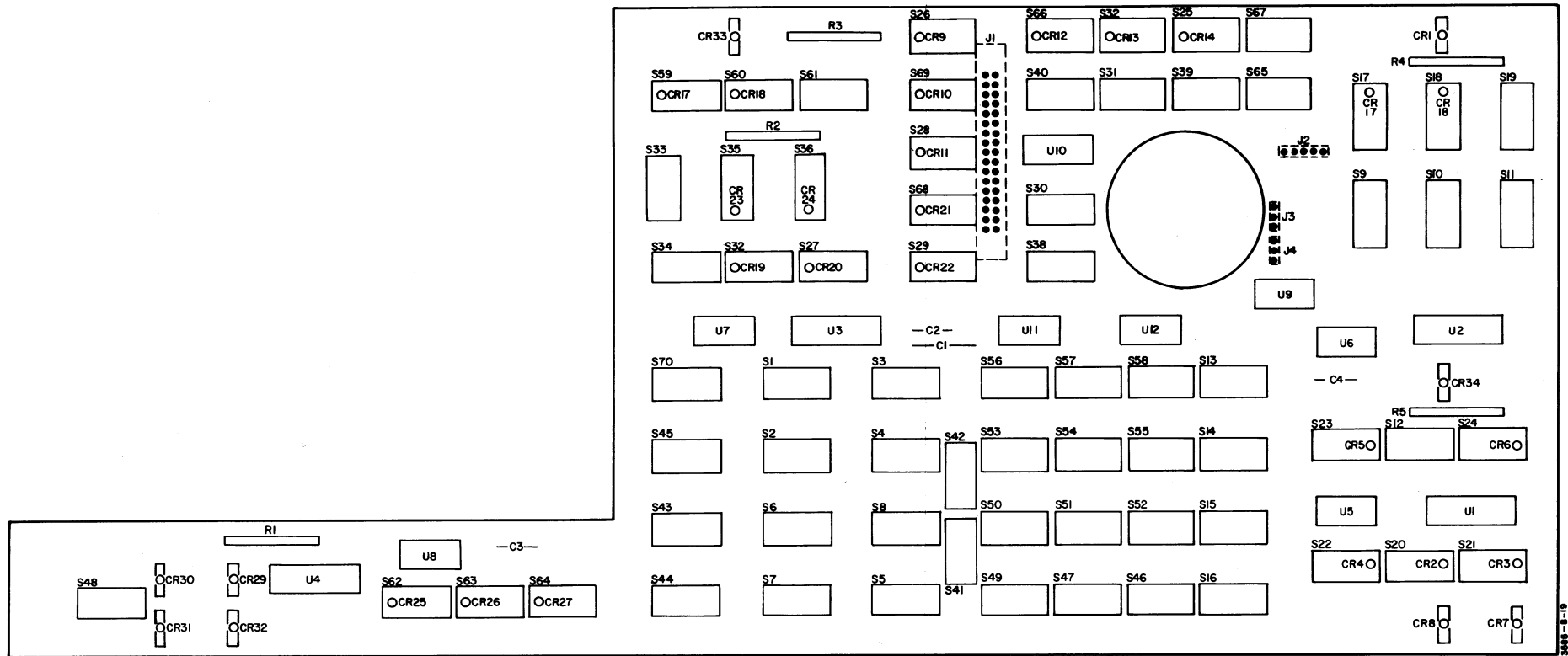
S48



A43  
03585-88543



A45  
03585-88545



A47  
03585-88547



## SERVICE GROUP D DISPLAY

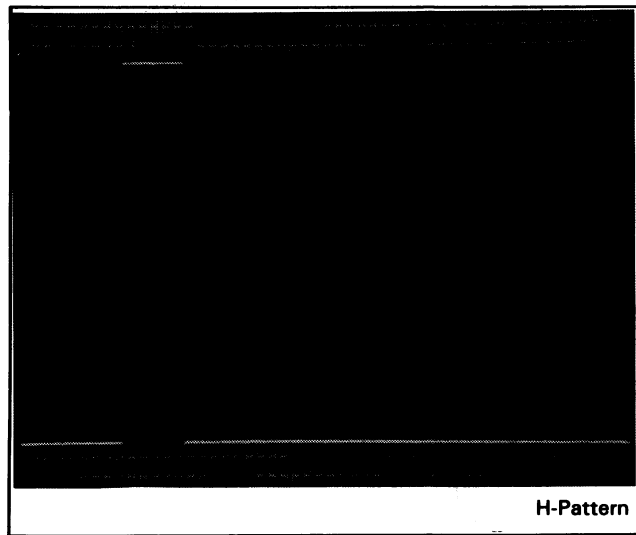
**Board Numbers A61,63-67**  
**Part Numbers 03585-66561, -66563 thru -66567**

### INDEX

Title	Service Group	Page No.
Main Display Troubleshooting Tree	D	11-289/11-290
A61 Clock Generator Troubleshooting Tree	D-1	11-293/11-294
A63 Display Processor Kernel Test	D-2-1	11-297
A63 Display Processor Board Tests	D-2-2	11-299
A63 Display Processor Input Buffer Test	D-2-3	11-305
A64 Analog Display Driver Troubleshooting Tree	D-3	11-311/11-312
A64 Ramp Generator Troubleshooting Tree	D-3	11-315/11-316
A64 Y-Axis Line Drawer Troubleshooting Tree	D-3	11-317/11-318
A64 Sampling Troubleshooting Tree	D-3	11-313
A67 X and Y-Axis Deflection Amplifiers	D-4	11-320
A67 Z-Axis Amplifier	D-4	11-320
A67 100V Regulator	D-4	11-320
A67 High Voltage Oscillator	D-4	11-320
A67 CRT Adjustments	D-4	11-321

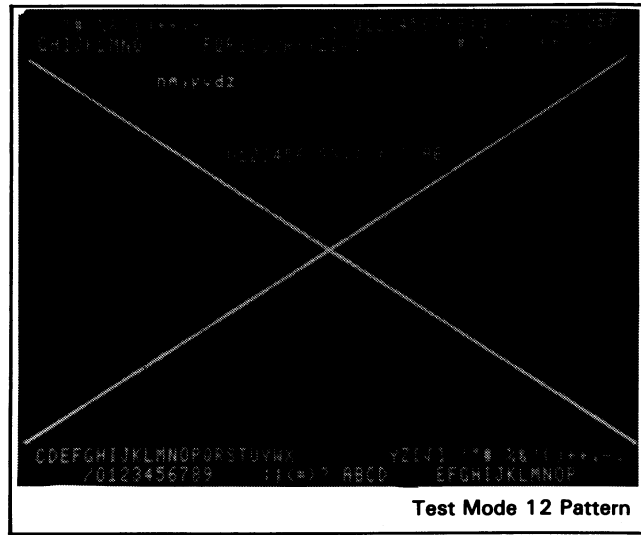
### EQUIPMENT REQUIRED:

Instrument	Required Characteristics	Recommended Model No.
Digital Multimeter	4½ digits dc Accuracy $\pm 0.05\%$ $\pm 3$ digits Range: 0.2V to 200V	-hp- 3466A
Oscilloscope	Bandwidth: dc to 100Mhz Vertical Sensitivity 0.005V/Div	-hp- 1740A
Digital Signature Analyzer	N.A.	-hp- 5004A



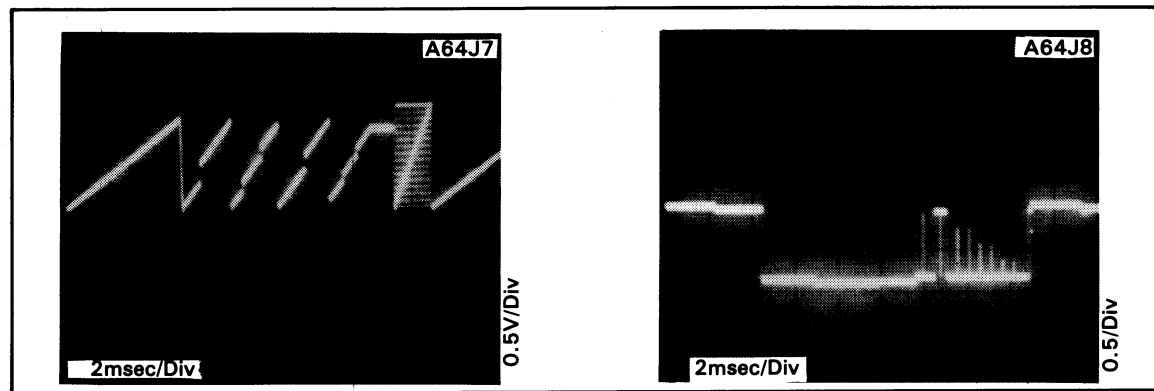
H-Pattern

**Figure 11-D-1. Display Test Pattern**  
(This pattern indicates that the Display Processor is functioning.)

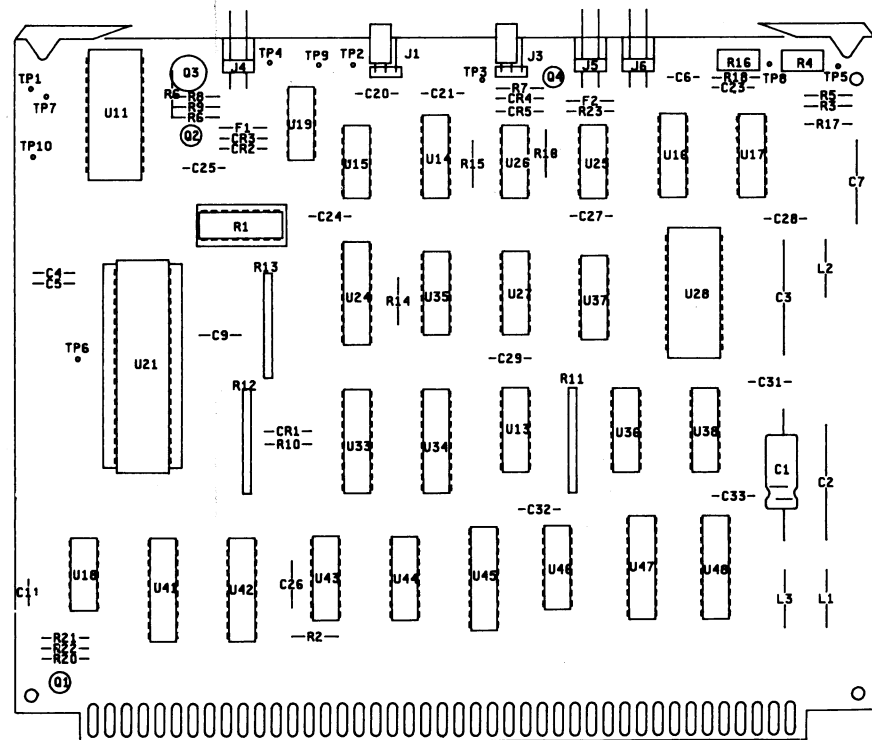


Test Mode 12 Pattern

**Figure 11-D-2. Processor Controlled Test Pattern**  
(This pattern indicates that the main processor is functioning.)

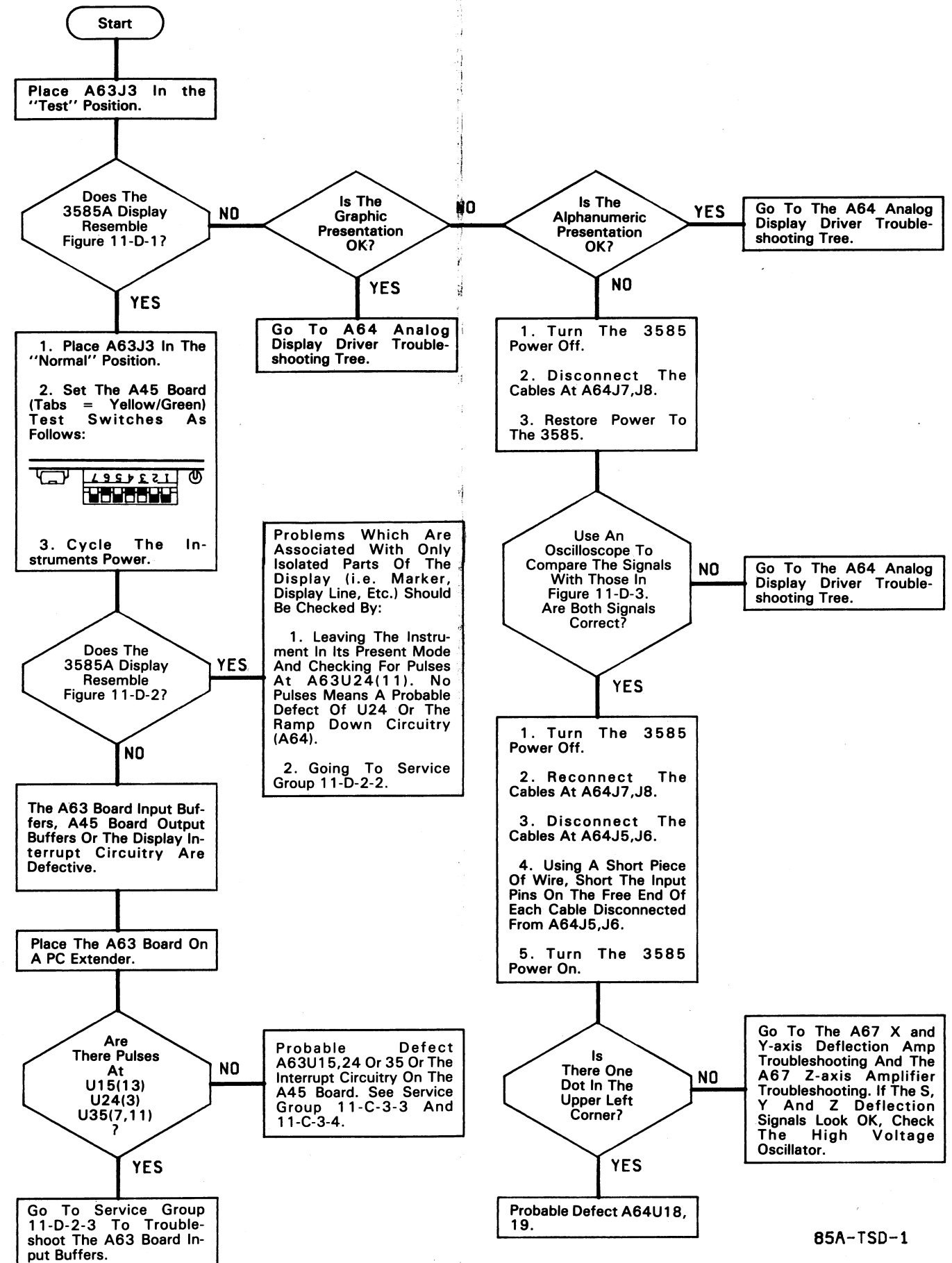


**Figure 11-D-3. A64 X and Y Outputs**



A63  
03585-68563

3585A-5-8



# **SERVICE GROUP D-1 CLOCK**

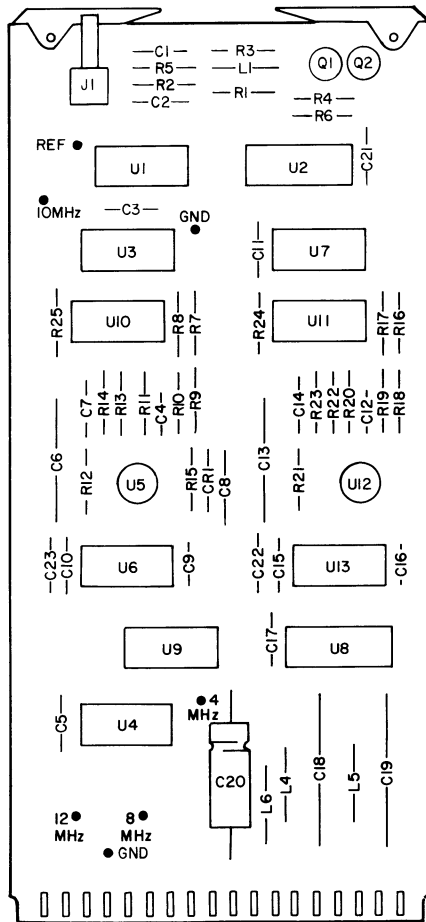
**Board No. A61  
-hp- Part Number 03585-66561**

## **INDEX:**

<b>Title</b>	<b>Page No.</b>
A61 Clock Generator Troubleshooting Tree.....	11-293/11-294

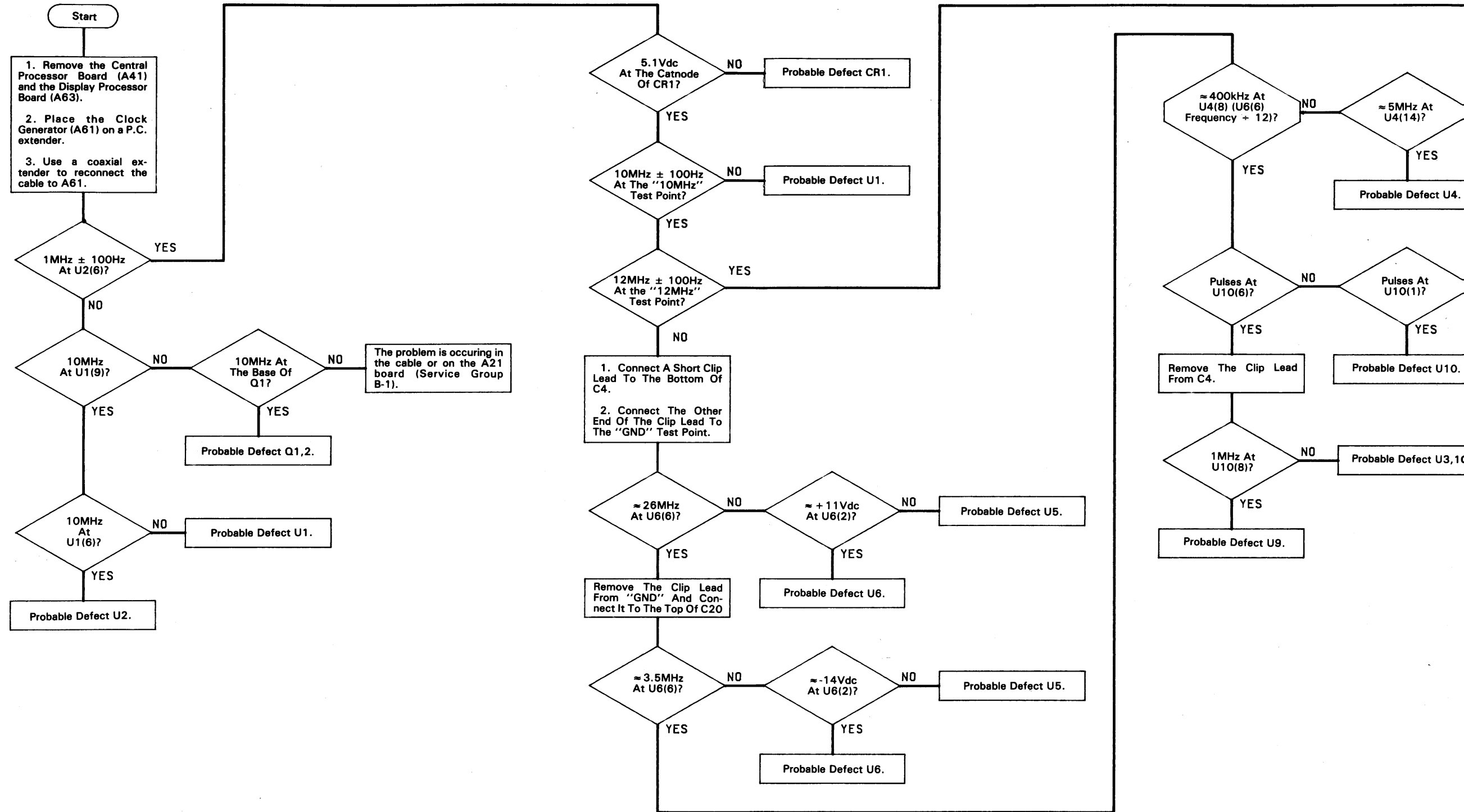
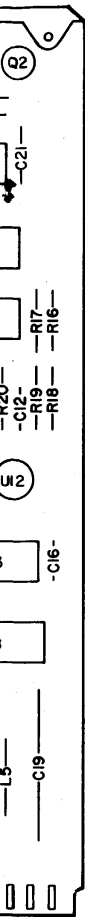
## **ADJUSTMENTS:**

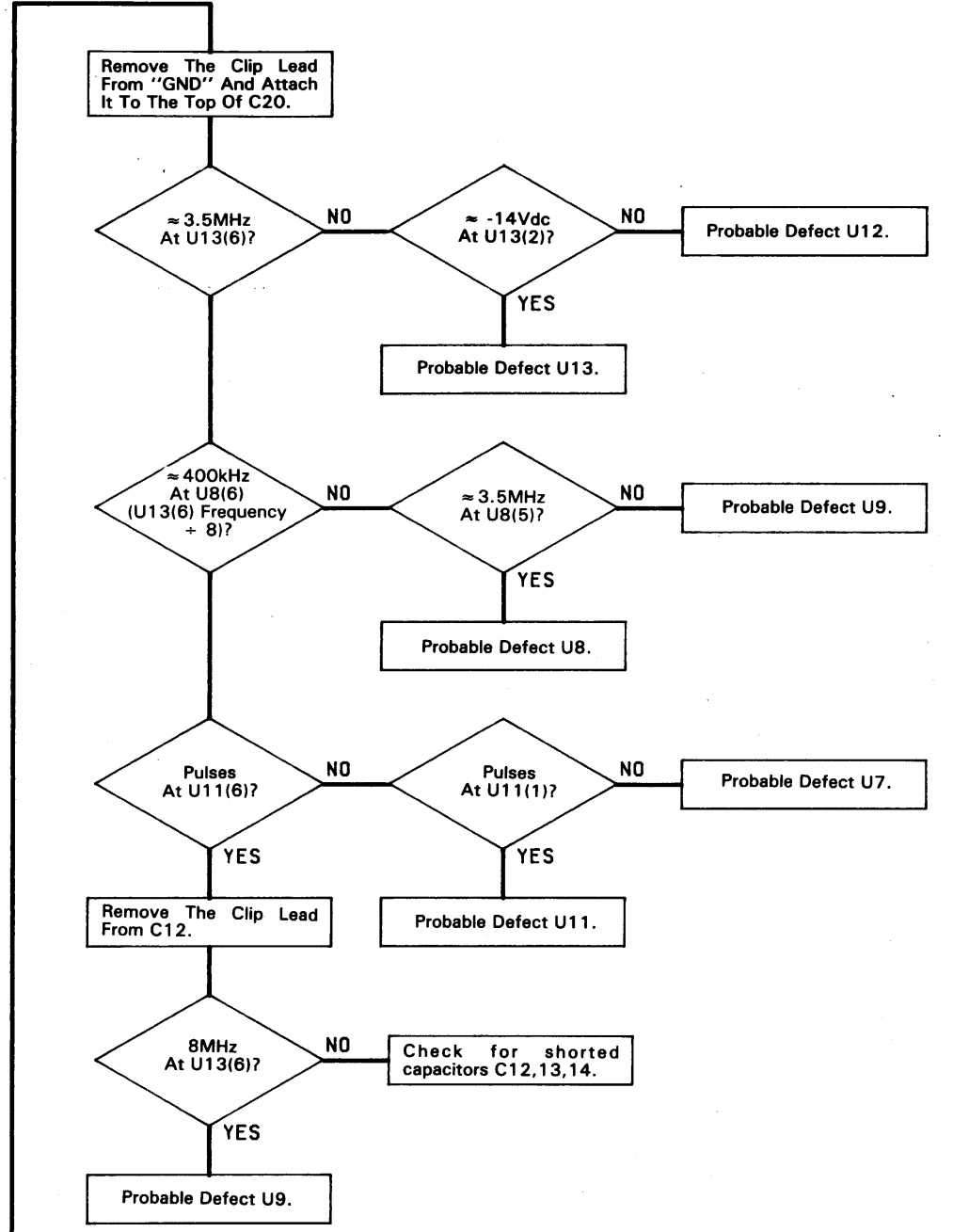
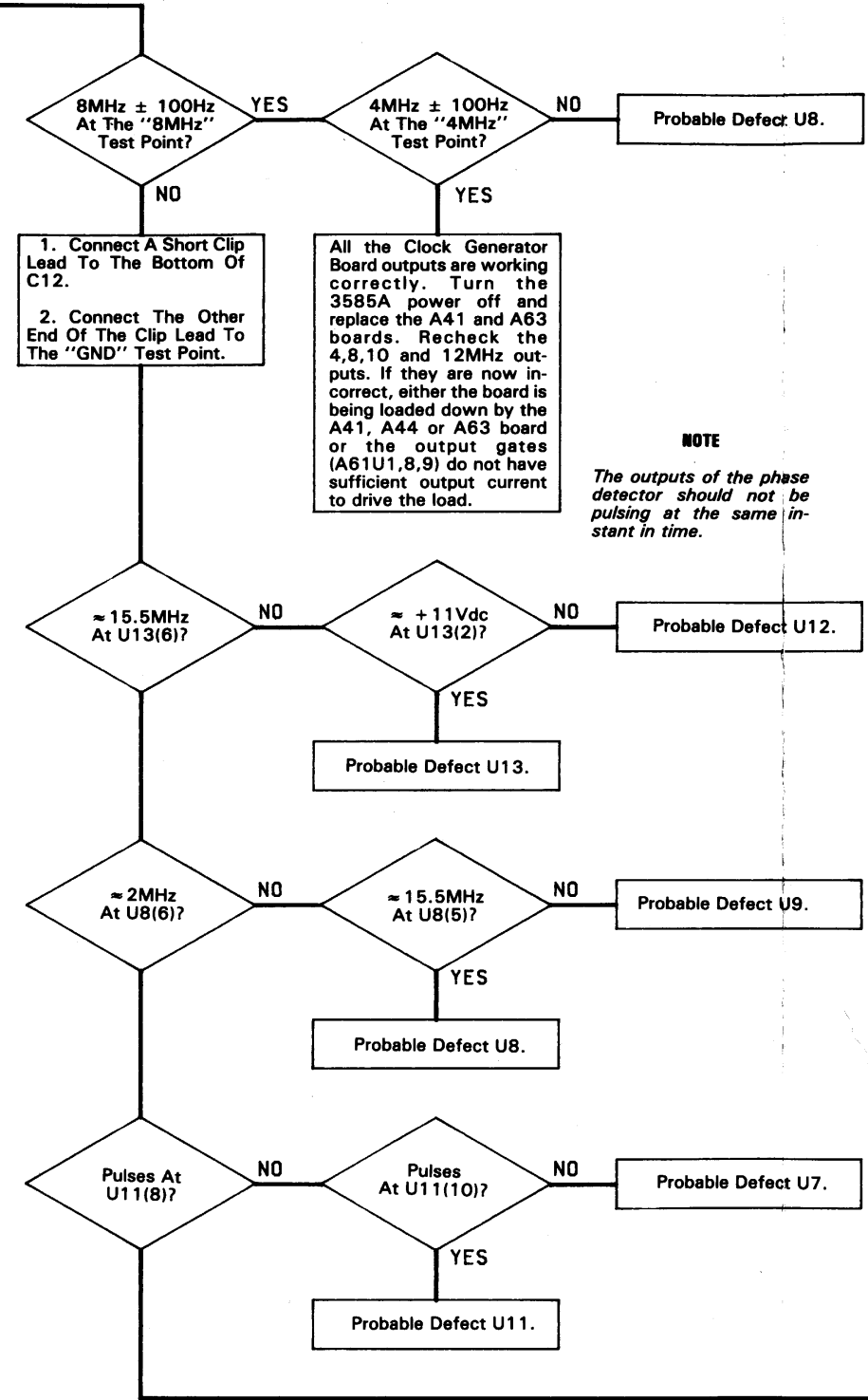
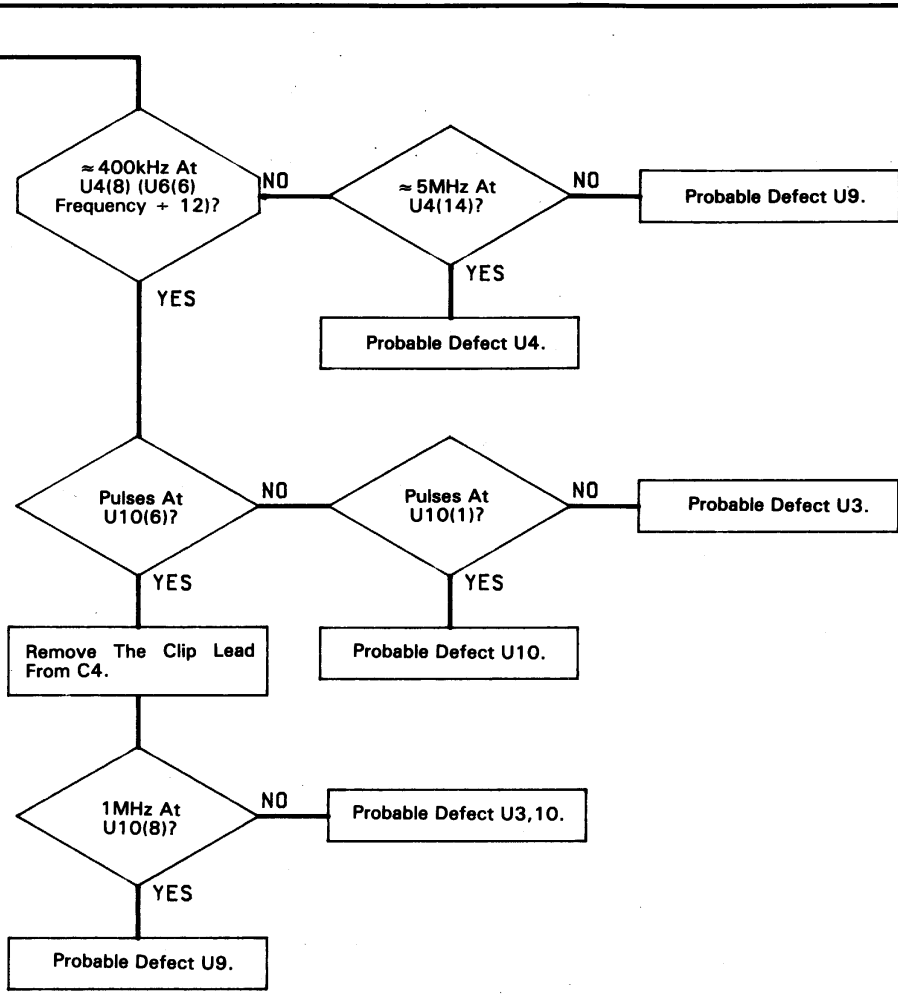
None



**A61**  
**03585-66561**

1  
 Pr  
 an  
 Bo  
 2  
 Ge  
 ex  
 3  
 te  
 ca





# SERVICE GROUP D-2 DISPLAY PROCESSOR

**Board Number A63**  
**Part Number 03585-66563**

## INDEX:

Title	DSA Test No.	Page No.
A63 Display Processor Kernal Test	11-D-2-1	11-297
A63 Display Processor Board Tests	11-D-2-2	11-299
A63 Display Processor Input Buffer Test	11-D-2-3	11-305

## ADJUSTMENTS:

Component	Adjusted Parameter	Paragraph No.
A63R4	Back Gate Bias	5-10
A63R16	Sample Width	5-10

# DSA Test No. 11-D-2-1 Display Processor Kernal Test

Turn the 3585A power off.

**Areas Tested:**

Display Processor  
Display Processor ROM

**Remove Boards:**

A41,A45




**Place on PC Extender:**

A63  
Remove A63R1

**Connect the Signature Analyzer as follows:**

START and STOP .....	A63TP7
CLOCK .....	A63TP1
GND .....	A63TP10

**Set the Signature Analyzer controls as follows:**

START .....		(in)
STOP .....		(out)
CLOCK .....		(in)

Turn the 3585A power on.

**The test is running correctly when:**

- The 5V signature (A63 pin A40) reads 7A70.

**If the test is running correctly, do the following:**

1. Check the signatures in Table 11-D-1.
  - a. If the signatures are correct, go on to DSA Test 11-D-2-2.
  - b. If the signatures are incorrect replace the component with the faulty output.
2. If the test is running incorrectly: (Check A41 & A45)
  - a. Move A63JMP1 to the "T" position and then back to the "N" position. This should start the Display Processor program.
  - b. Check for the 4MHz Master Clock at A63TP1. The 4MHz Clock rise time should be greater than 15nsec and less than 70nsec. It is typically 25nsec.



- c. Check U21(16,18-25,29) for a TTL high. If all the pins are not high, replace the component (U33,U34,U21,R12) which is causing one or more of the pins to be low. If all the pins are TTL high replace U21. If U21(29) is low check for a TTL high at U15(3). If this pin is low or pulsing, the problem is on the A45 board (I/O, Service Group 8-C-3-1). Now check for a TTL low at U21(30) and pulses (750nsec period) at U21(28). The Probable Defect is U21 if either signal is incorrect. Finally check for a TTL high at U15(2). Probable Defect is U17 if a TTL low is not present. If all the above checks OK, replace U15.

**Table 11-D-1. Display Processor Kernal Test Signatures**

+ 5 V = 7A70

U11 Pin	Signature	U21 Pin	Signature
1	9635	1	C21A
2	0772	2	HA07
3	4U2A	3	HOAA
4	4442	4	P030
5	P030	5	4442
6	HOAA	6	4U2A
7	HA07	7	0772
8	C21A	8	9635
9	CUAA	9	1734
10	239H	10	8P54
11	299C		
13	F22P		
14	6FOP		
15	A06F		
16	H9AC		
17	9410		
18	0000		
22	8P54		
23	1734		

# DSA Test No. 11-D-2-2 Display Processor Board Tests

Turn the 3585A power off.

Areas Tested:

A63 board

Remove Boards:

A41  
A45

Place on PC Extender:

A63

Place in the "Test" position:




A63J3

(Check that A63R1 is in its socket)

Connect the Signature Analyzer as follows:

START and STOP . . . . .	A63TP4
CLOCK . . . . .	A63TP1
GND . . . . .	A63TP10

Set the Signature Analyzer controls as follows:

START . . . . .		(in)
STOP . . . . .		(out)
CLOCK . . . . .		(out)

Turn the 3585A power on.

The test is running correctly when:

- The 5V signature (A63 pin 40) reads H080.

If the test is running correctly, do the following:

1. Observe the CRT display.
  - a. If the display looks like Figure 11-D-2-2, the display section is operating correctly. If the display is incorrect during normal operation the problem is in the Display board input buffers (A63U41,42), I/O board out buffers (A45U15,16), the Low Level Interrupt or DMA Request circuitry. Run the Display Processor Input Buffer Test (DSA Test 11-D-2-3).
  - b. If the alphanumeric are incorrect, but the graphic display is still correct, go to step 2.

- c. If the graphic display is incorrect, but the alphanumeric outputs are still correct, go to step 3.
  - d. If the entire CRT presentation is incorrect or blank, do both steps 2 and 3.
2. To check the Alphanumeric outputs, check the signatures in Table 11-D-2.
    - a. If the signatures are correct, the problem is occurring after the Display Processor board. Go to the Analog Display Driver Troubleshooting (Service Group 11-D-3).
    - b. If the signatures are wrong, use the schematic and the Secondary Signatures (Table 11-D-4) to locate the problem.
  3. To check the Graphic display outputs, check the signatures in Table 11-D-3.
    - a. If the signatures are correct, the problem is occurring after the Display Processor board. Go to the Analog Display Driver Troubleshooting (Service Group 11-D-3).
    - b. If the signatures are wrong, use the schematic and the Secondary Signatures (Table 11-D-4) to locate the problem.

**NOTE**

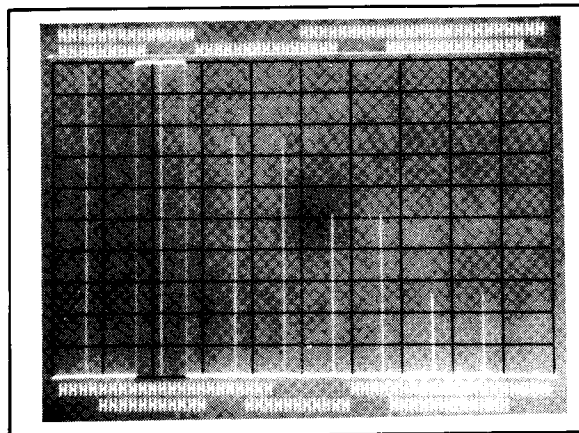
*If all the aforementioned tests check good, then the problem is in the Display Processor Interrupt receiving circuitry. This consists of U35, U24, U15 and U17. Using a logic probe, check the following points for a pulsing condition with the instrument running DSA Test 11-C-3-2:*

*U21(12,13,14,15,27,28,29,30,37)*

*If all of these pins are pulsing replace A63U21. If some of the pins are not pulsing, use the schematic to determine which IC (U35,24,25,17) to replace.*

If the test is not running correctly:

1. Move A63J1 to the "Test" position, then back to the "Normal" position.
2. Run the display Processor Kernal Test (DSA Test 11-D-2-1).



**Table 11-D-2. Display Processor Alphanumerics - Primary Signatures**

U48 Pin	Signature	U45 Pin	Signature	U47 Pin	Signature
2	P579	2	965U	6	H080
5	8H32	5	AUUC	9	H080
6	F179	6	965U		
9	C3H9	9	FP5C		
11	903A	12	08CO		
12	U86H	15	1923		
15	H2H8	16	6910		
16	U1U1	19	7883		

U43 Pin	Signature	U44 Pin	Signature	U24 Pin	Signature
12	45U6	12	FFCO	5	40A2
13	P654	13	2F2P		
14	9FC7	14	1A8F		
15	9HH3	15	4CCH		

**Table 11-D-3. Display Processor Graphics - Primary Signatures**

U47 Pin	Signature	U43 Pin	Signature	U44 Pin	Signature	U24 Pin	Signature
6	H080	12	45U6	12	FFCO	5	40A2
9	H080	13	P654	13	2F2P		
16	A172	14	9FC7	14	1A8F		
19	4039	15	9HH3	15	4CCH		

U26 Pin	Signature	U16 Pin	Signature	U14 Pin	Signature
6	4H17	5	3899	2	7H5P
				7	C270

**Table 11-D-4. Display Processor - Secondary Signatures**

Inputs		Outputs		Inputs	
U28 Pin	Signature	U28 Pin	Signature	U37 Pin	Signature
1	H8HC	9	95P7	11	FHUA
2	PUFH	10	FC5H	12	469H
3	6H88	11	29A4	14	2181
4	1783	12	0000		
5	3P16	13	5A30		
6	9PPF	14	2450		
7	AAPO	15	08C9		
8	1F7P	16	8C7C		
23	C84U				

**Table 11-D-4. Display Processor-Secondary Signatures (Cont'd)**

Inputs		Outputs		Inputs	
U37 Pin	Signature	U38 Pin	Signature	U38 Pin	Signature
1	H080	11	FHUA	1	H080
9	H080	12	1C87	9	H080
10	H080	14	2181	10	H080
15	H080			15	H080
Inputs		Outputs		Unstable	
U35 Pin	Signature	U35 Pin	Signature	U24 Pin	Signature
1	PP17	7	2371	3	H080
2	CCH4	9	2157	4	40A2
3	C6P5	10	2954	5	40A2
4	8A49	11	17HP	8	2181
5	0000	12	A381	9	2181
		13	903A	13	U1U1
		14	FHUA	14	U1U1
		15	9824	15	0001
				16	0001
Inputs		Outputs		Outputs	
U34 Pin	Signature	U34 Pin	Signature*	U27 Pin	Signature
2	H9CA	3	6623	15	H080
4	128F	5	10CO		
6	CA04	7	7717		
8	3F8U	9	F4H5		
12	120C	11	5482		
14	2HA7	13	8669		
16	7A69	15	HHPP		
18	8C48	17	031C		
Inputs		Outputs		Outputs	
U47 Pin	Signature	U47 Pin	Signature	U16 Pin	Signature
13	F4H5*	12	FFCO	9	0000
14	7717*	15	2F2P	14	OHC5
3	10CO*	2	1A8F		
4	6623*	5	4CCH		
7	H080*	6	H080		
8	H080*	9	H080		
17	752U				
18	4190				
11	H080*				

\*Signature Clock = (in)

**Table 11-D-4. Display Processor-Secondary Signatures (Cont'd)**

U46 Pin	Signature	U43 Pin	Signature	U25 Pin	Signature	U26 Pin	Signature
3	H080	1	H080	1	UHPF	4	OHC5
6	H080	2	H080	4	8PPH	5	40A2
10	H080	5	H080	8	0000	8	P33C
13	H080	6	H080	9	9824	9	H080
				10	48A4	10	33CC
				12	0000		
				13	7301		

## DSA Test No. 11-D-2-3 Display Processor Input Buffer Test

Turn the 3585A power off.

Areas Tested:

A63U41,42

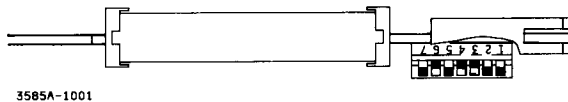
Remove Boards:

NA

Place on PC Extender:

A63

Set A45 Test Switch to:



(Black indicates switch position)

Place A63J3 in the "normal" position.

Connect the Signature Analyzer as follows:

START and STOP .....	A45TP1
CLOCK .....	A45TP2
GND .....	Chassis Ground

Set the Signature Analyzer controls as follows:

START .....	(out)
STOP .....	(in)
CLOCK .....	(in)

Turn the 3585A power on.

The test is running correctly when:

- The 5V signature (A63 pin A40) reads 29UP.

If the test is running correctly, do the following:

1. Check the signatures in Table 11-D-5.
  - a. If the signatures are correct, the Display Processor Input buffers are good. (Remote possibility of A63U46,U44,U43 being bad if only the graphics are bad.) Check the DMA request circuitry by running the DMA request test in Service Group 11-C-3-3 and Service Group 11-C-3-4.

- b. If only the output signatures are bad then replace U41 or U42. If the signature on U41 or U42 pin 11 is bad replace U35. If the input signatures are bad, go to Service Group 11-C-3-2.
2. If the test is running incorrectly:
- a. Momentarily short the LRESET test point on the A41 board to the pin next to it.

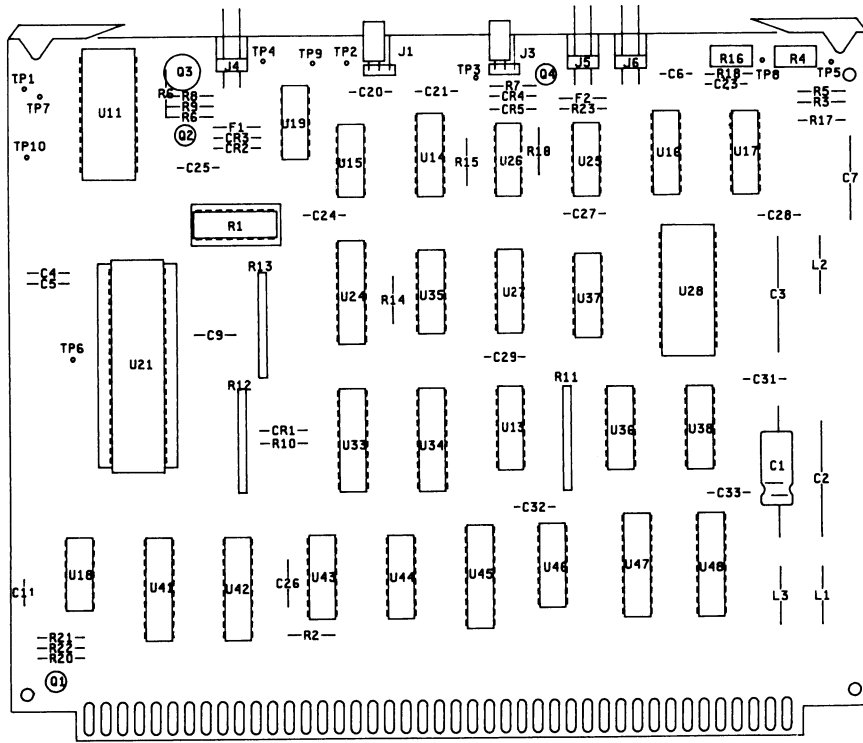
**Table 11-D-5. Display Processor Input Buffers**

5V = 29UP			
Inputs		Outputs	
U41 Pin	Signature	U41 Pin	Signature
3	CU78	2	CU78
4	447C	5	4479
7	OC71	6	OC73
8	3189	9	318C
13	6PH3	12	6PH1
14	1562	15	1560
17	87PP	16	87PP
18	AF44	19	AF44
11	29UP		

Inputs		Outputs	
U42 Pin	Signature	U42 Pin	Signature
3	941F	2	941F
4	HC40	5	HC40
7	83HA	6	83HA
8	1426	9	1426
13	C13C	12	C13C
14	7668	15	7668
17	69FP	16	69FP
18	1H2F	19	1H2F
11	29UP		





3585A-5-8

A63  
03585-66563

# SERVICE GROUP D-3 ANALOG DISPLAY DRIVER

**Board Number A64  
Part Number 03585-66564**

**INDEX:**

Title	Page No.
A64 Analog Display Driver Troubleshooting Tree.....	11-311/11-312
A64 Sampling Troubleshooting.....	11-313
A64 Ramp Generator Troubleshooting Tree.....	11-315/11-316
A64 Y-axis Line Drawer Troubleshooting Tree.....	11-317/11-318

**ADJUSTMENTS:**

Component	Adjusted Parameter	Page No.
A64R1	X-axis character spacing	5-12
A64R14	Alphanumeric offset	5-12
A64R16	Y-axis line spacing	5-12
A64R48	Line Drawer offset	5-12
A64R62	Integrator Gain	5-12
A64R72	5V Reference Regulator	5-12
A64C23	Pedestal Compensation	5-12

Figure 11-D-3-20

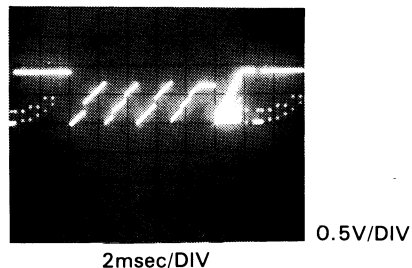


Figure 11-D-3-9

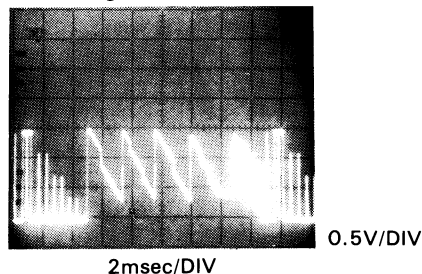


Figure 11-D-3-19

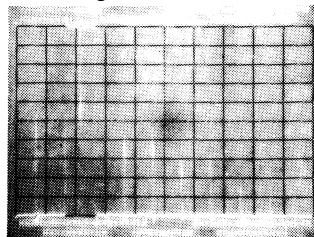


Figure 11-D-3-7

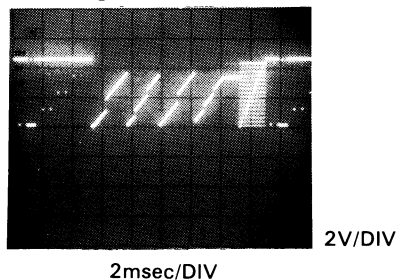


Figure 11-D-3-16A

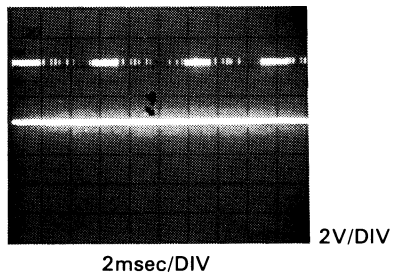
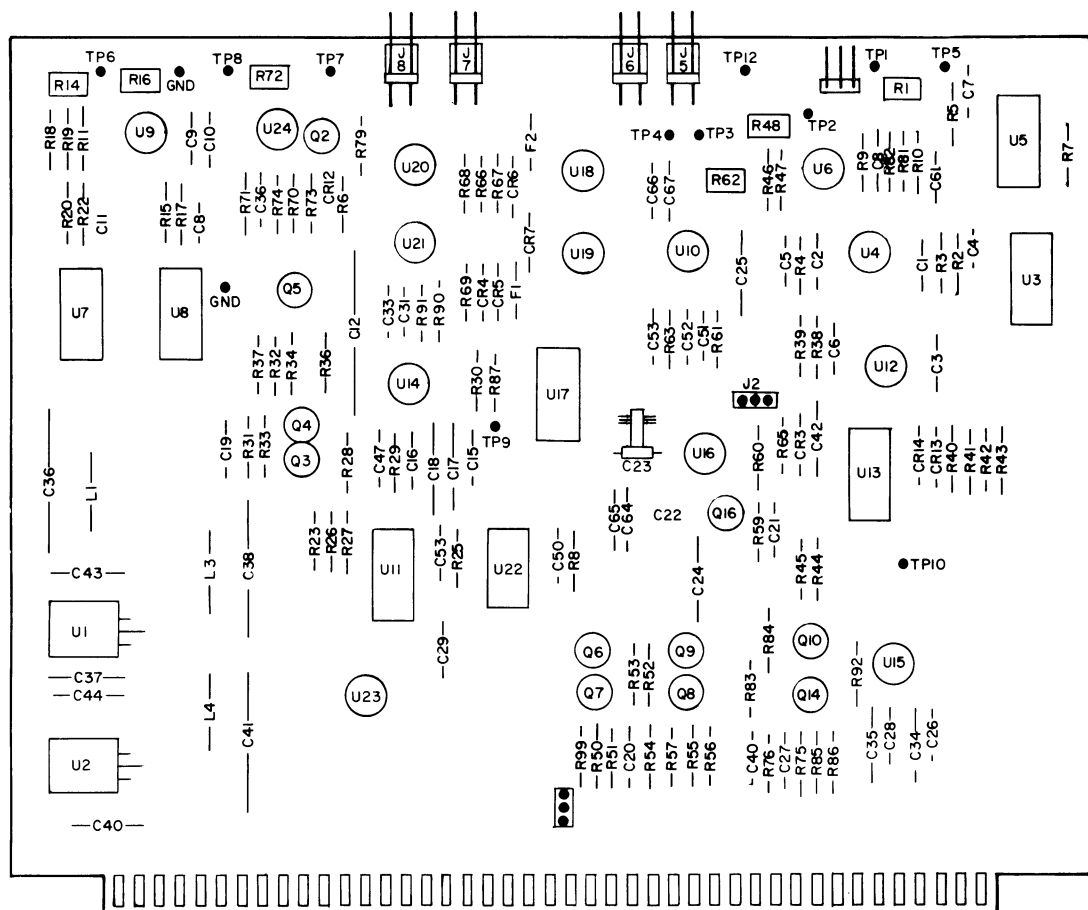
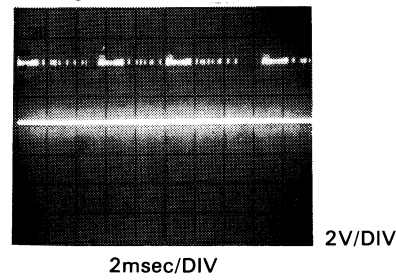
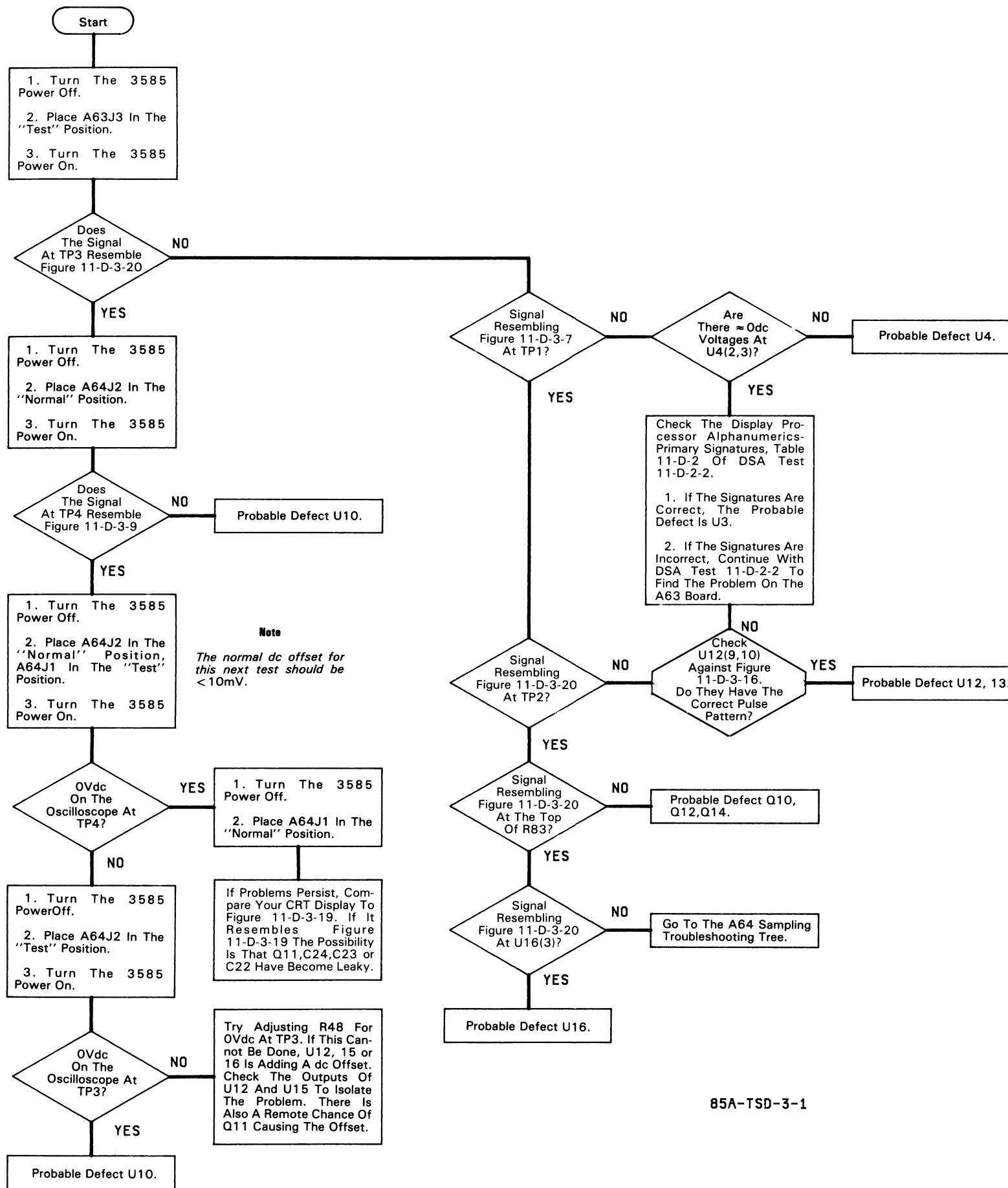


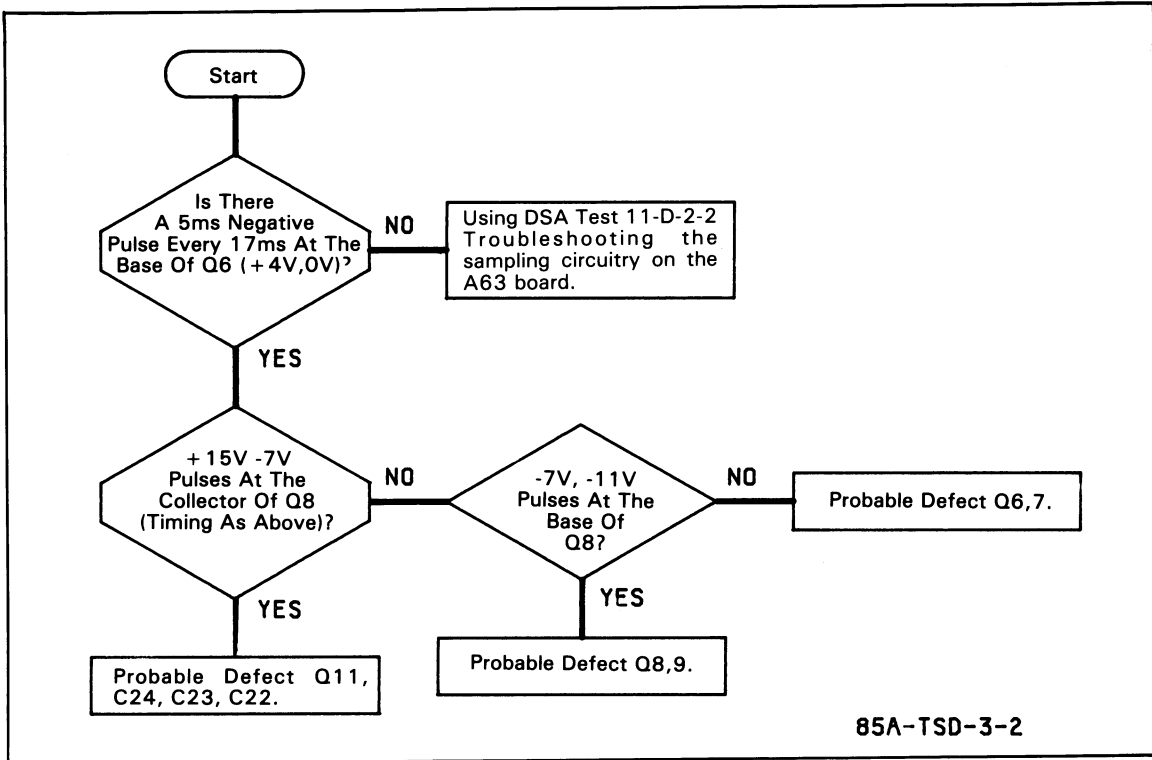
Figure 11-D-3-16B



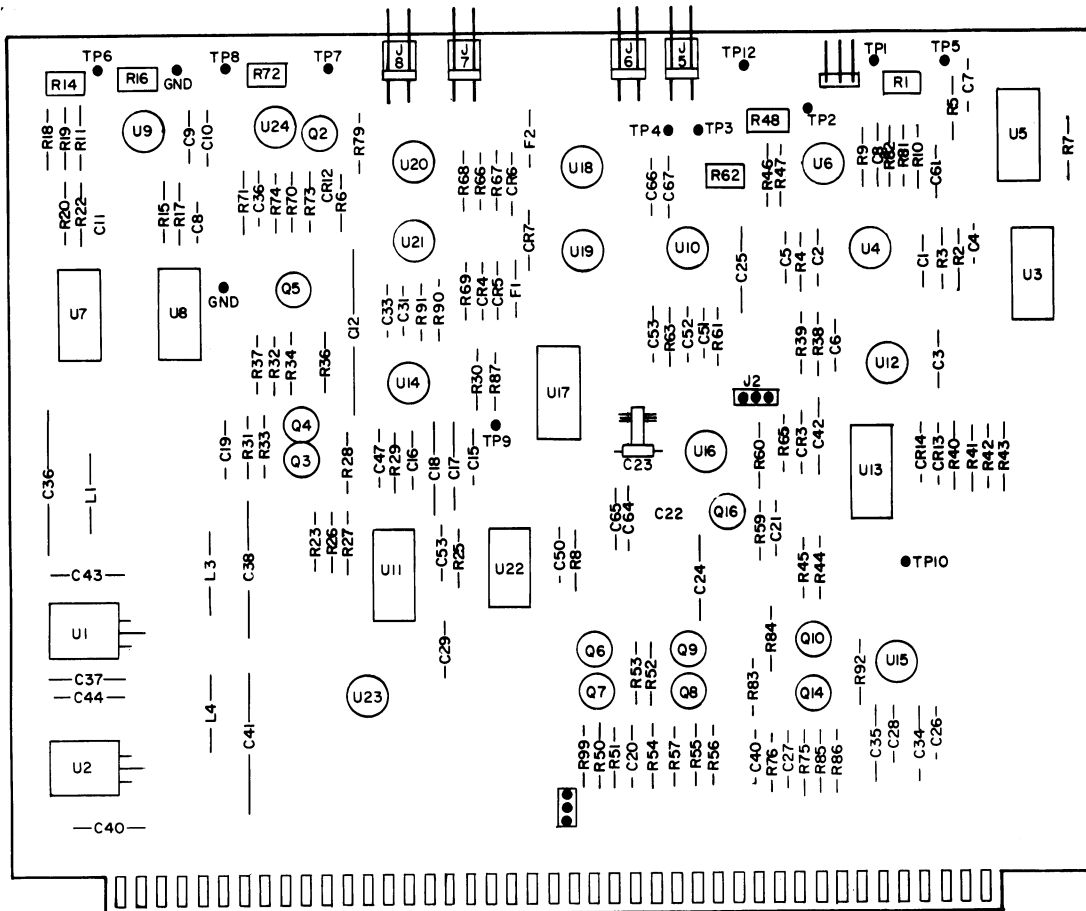
A64  
03585-66564



85A-TSD-3-1

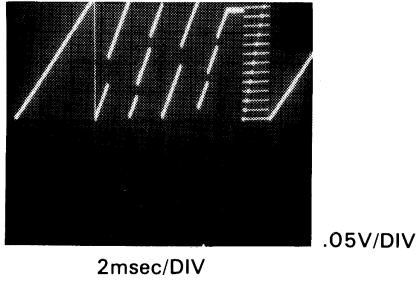


**A64 Sampling Troubleshooting Tree**

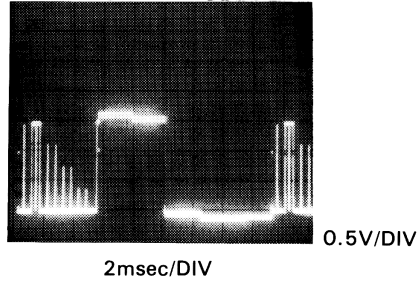


A64  
03585-66564

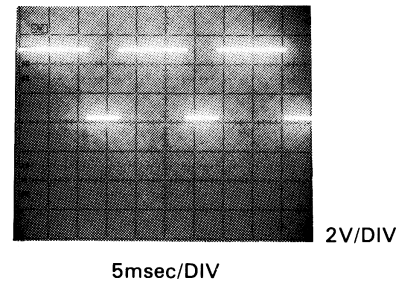
**Figure 11-D-3-2**



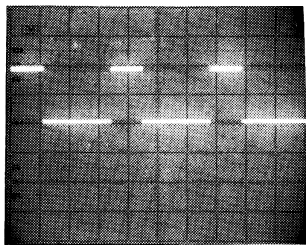
**Figure 11-D-3-3**



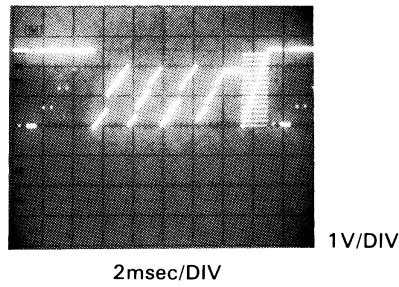
**Figure 11-D-3-4**



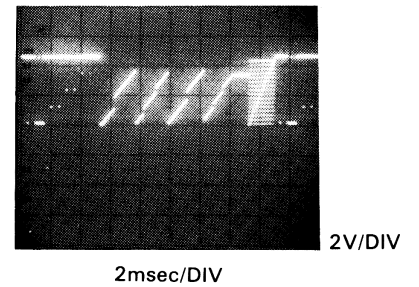
**Figure 11-D-3-5**



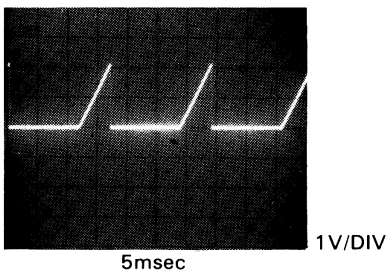
**Figure 11-D-3-6**



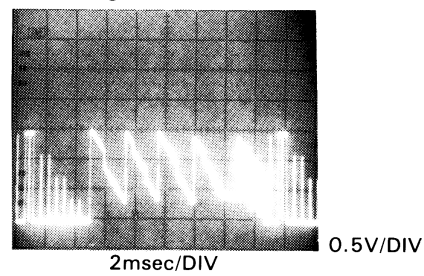
**Figure 11-D-3-7**



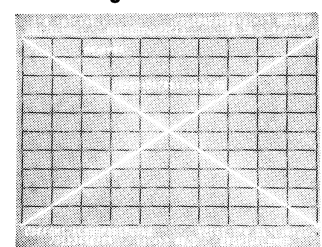
**Figure 11-D-3-8**



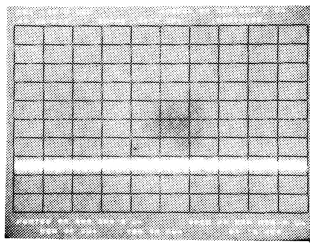
**Figure 11-D-3-9**



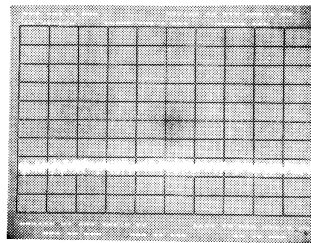
**Figure 11-D-3-10**



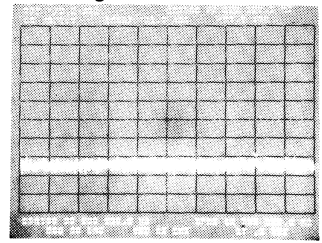
**Figure 11-D-3-11A**



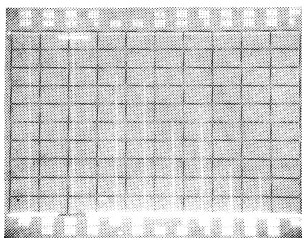
**Figure 11-D-3-11B**



**Figure 11-D-3-11C**



**Figure 11-D-3-12**



**Figure 11-D-3-13**

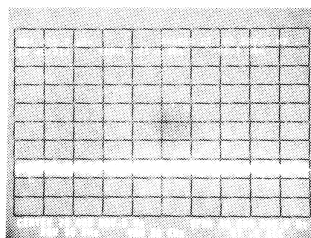


Figure 11-D-3-14A

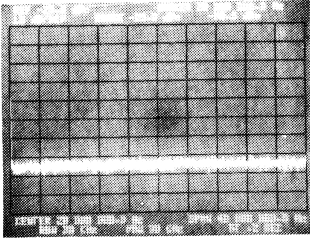


Figure 11-D-3-14B

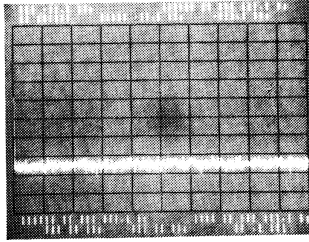


Figure 11-D-3-14C

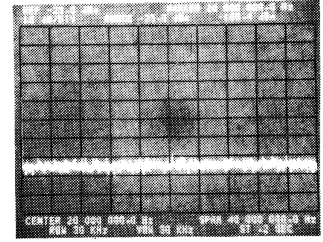


Figure 11-D-3-15

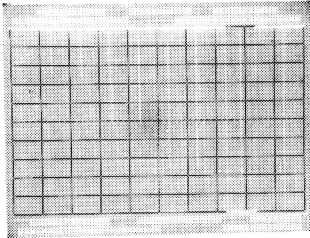
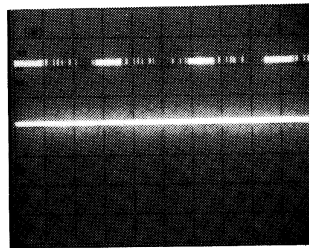


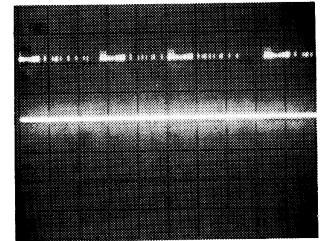
Figure 11-D-3-16A



2V/DIV

2msec/DIV

Figure 11-D-3-16B



2V/DIV

2msec/DIV

Figure 11-D-3-17A

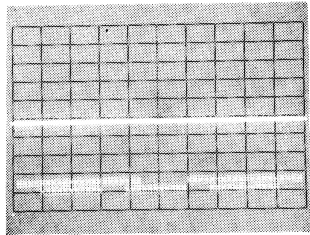


Figure 11-D-3-17B

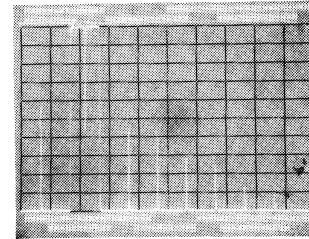


Figure 11-D-3-18A

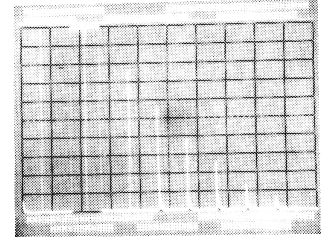


Figure 11-D-3-18B

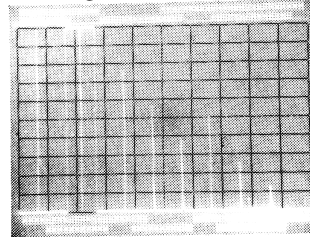


Figure 11-D-3-18C

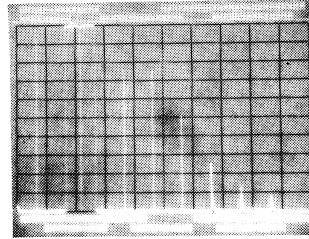
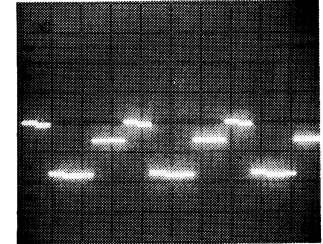


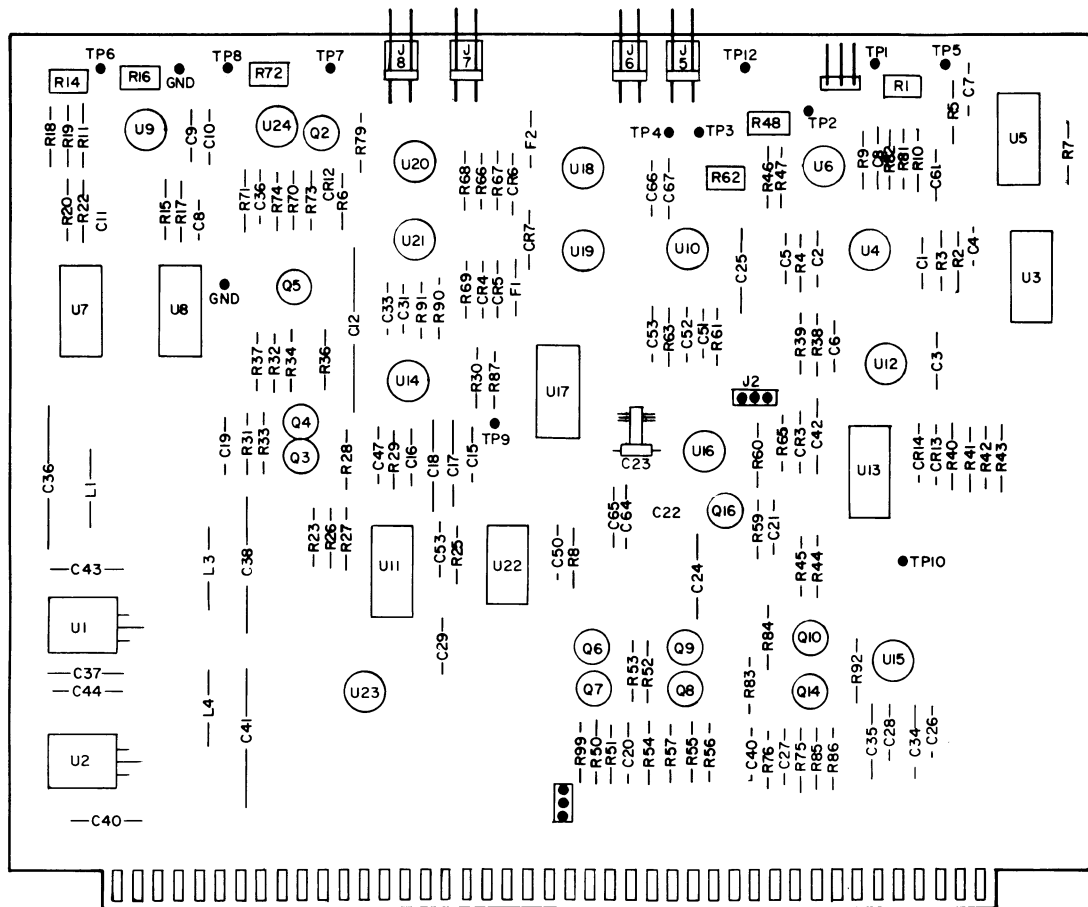
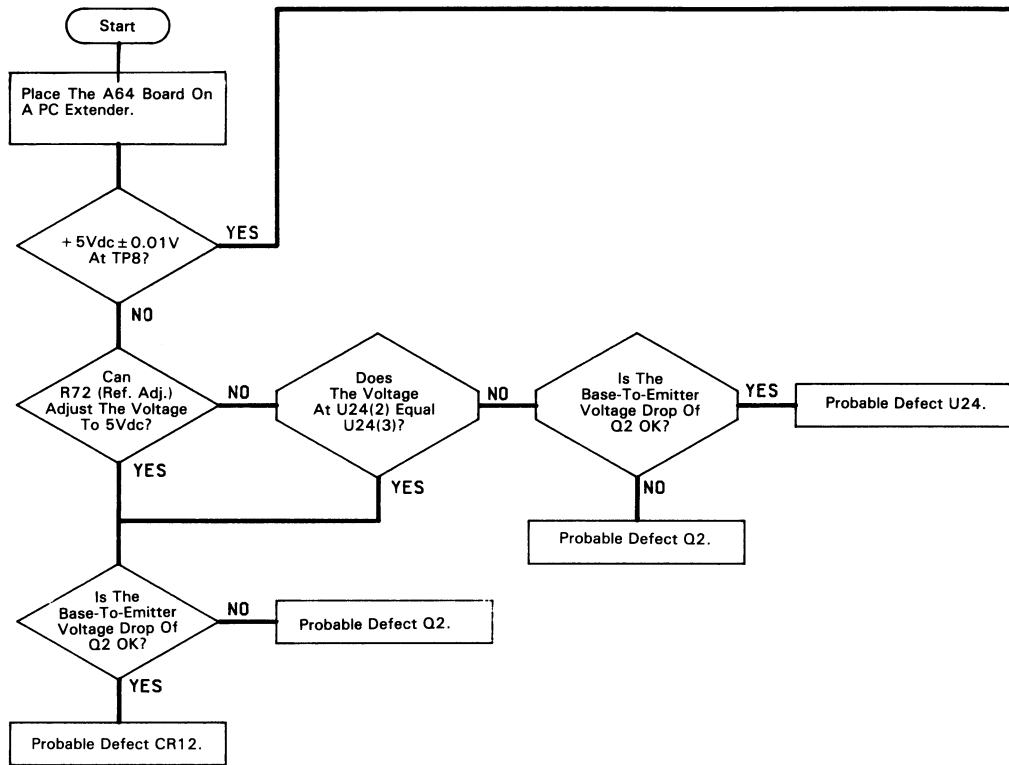
Figure 11-D-3-23



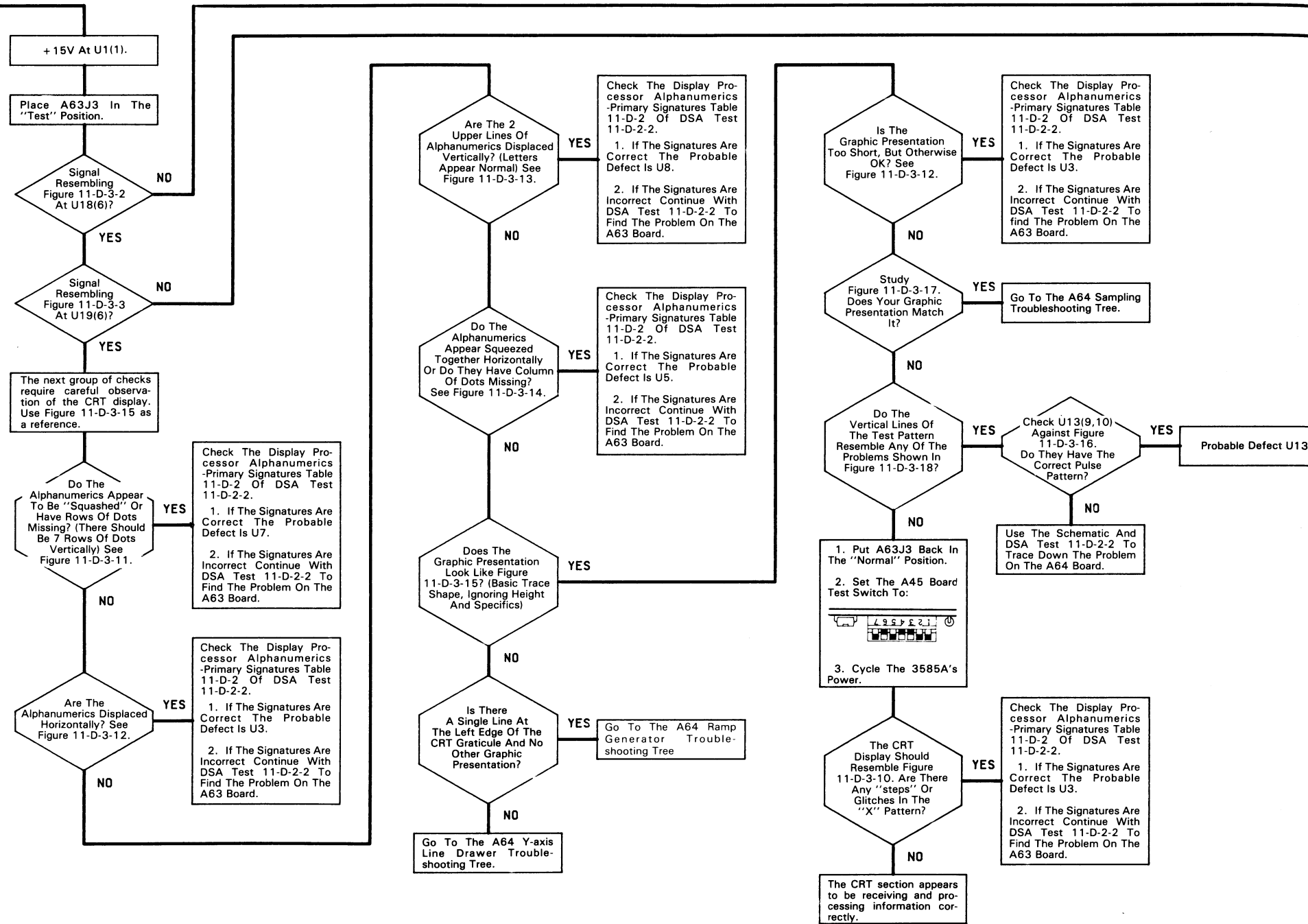
1V/DIV

5msec/DIV

This voltage is the reference for the DAC's, if it is incorrect the DAC's will not operate correctly.



A64  
03585-66564



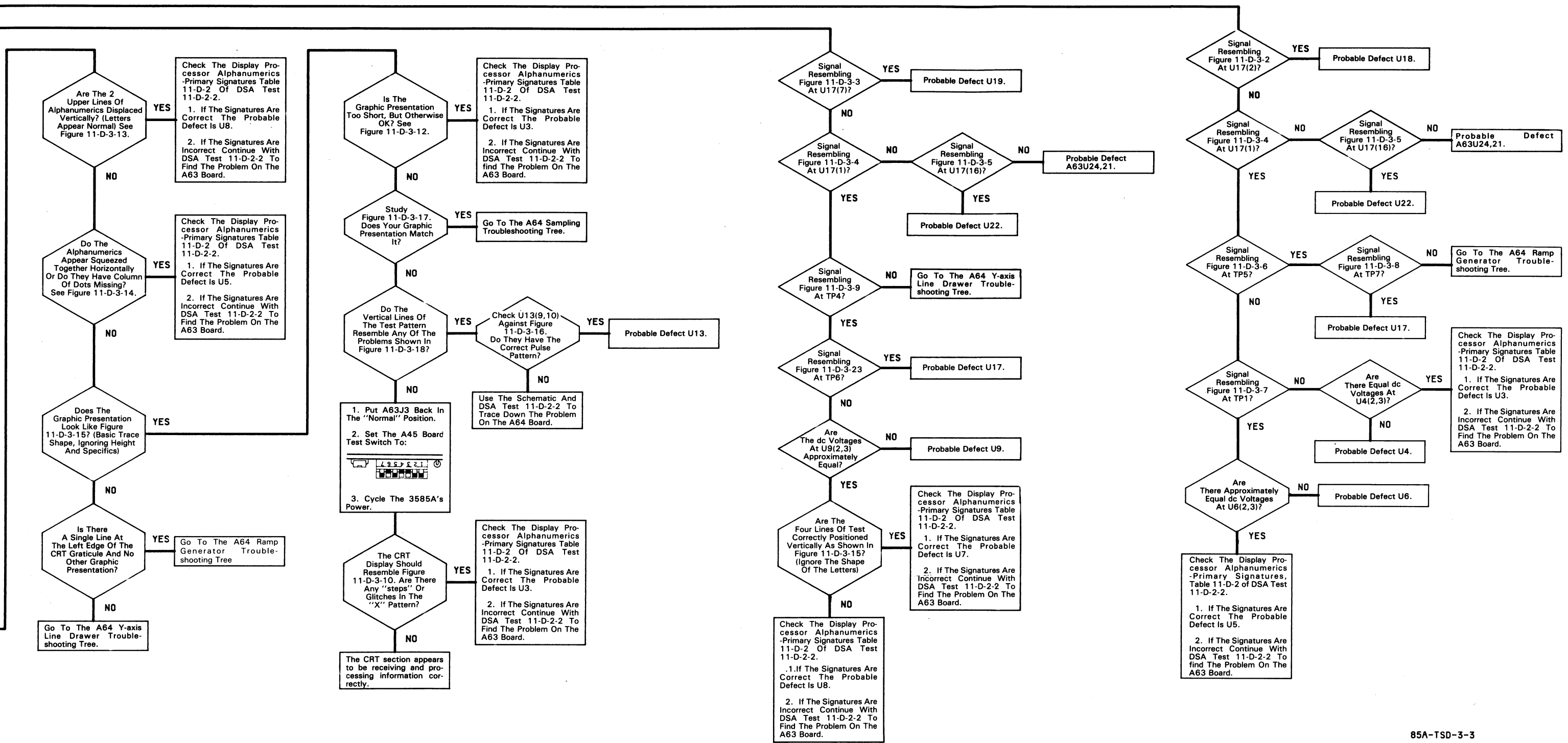




Figure 11-D-3-21

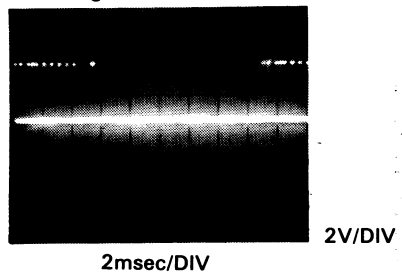


Figure 11-D-3-22

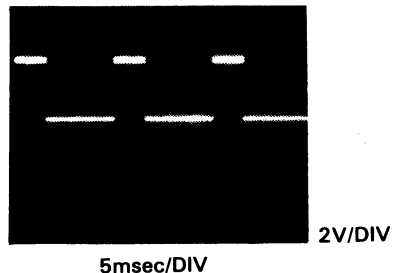
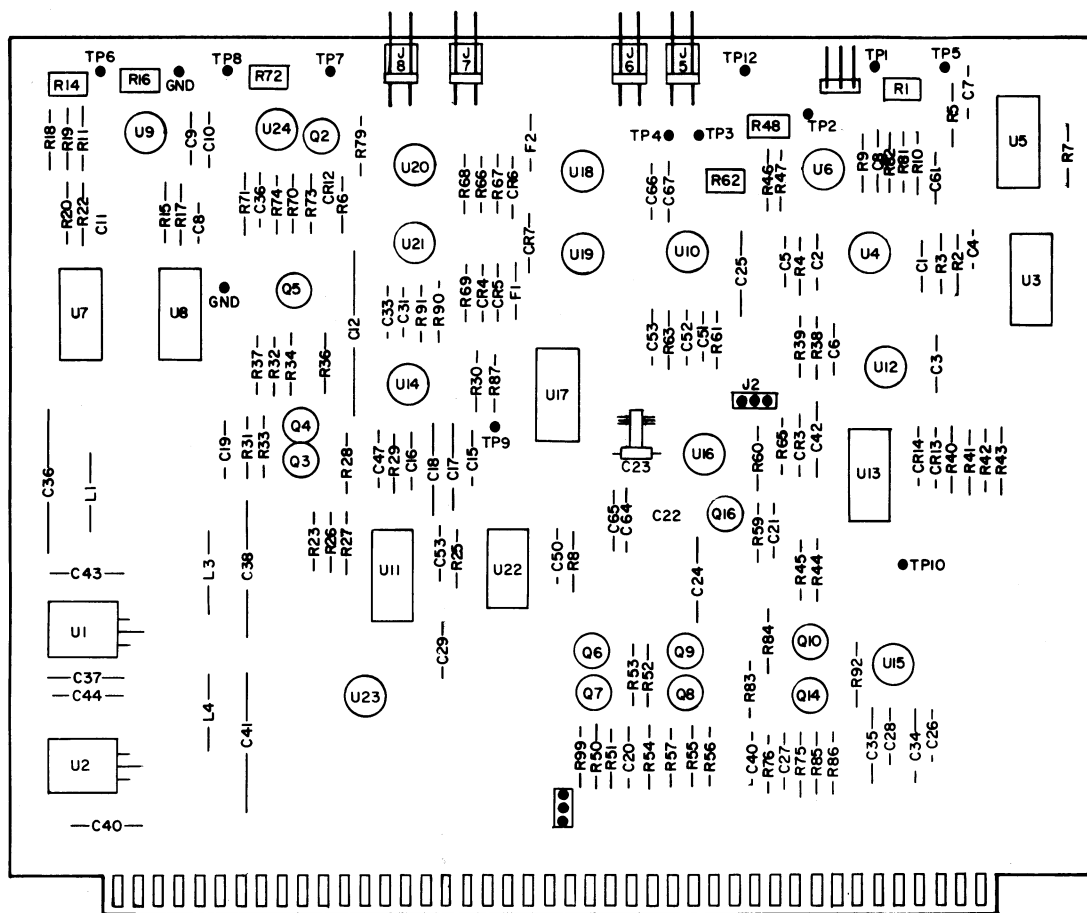
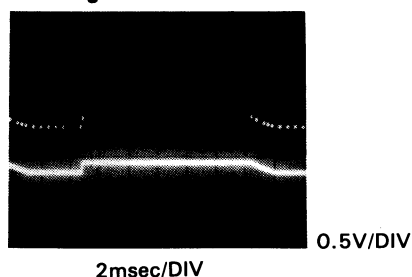
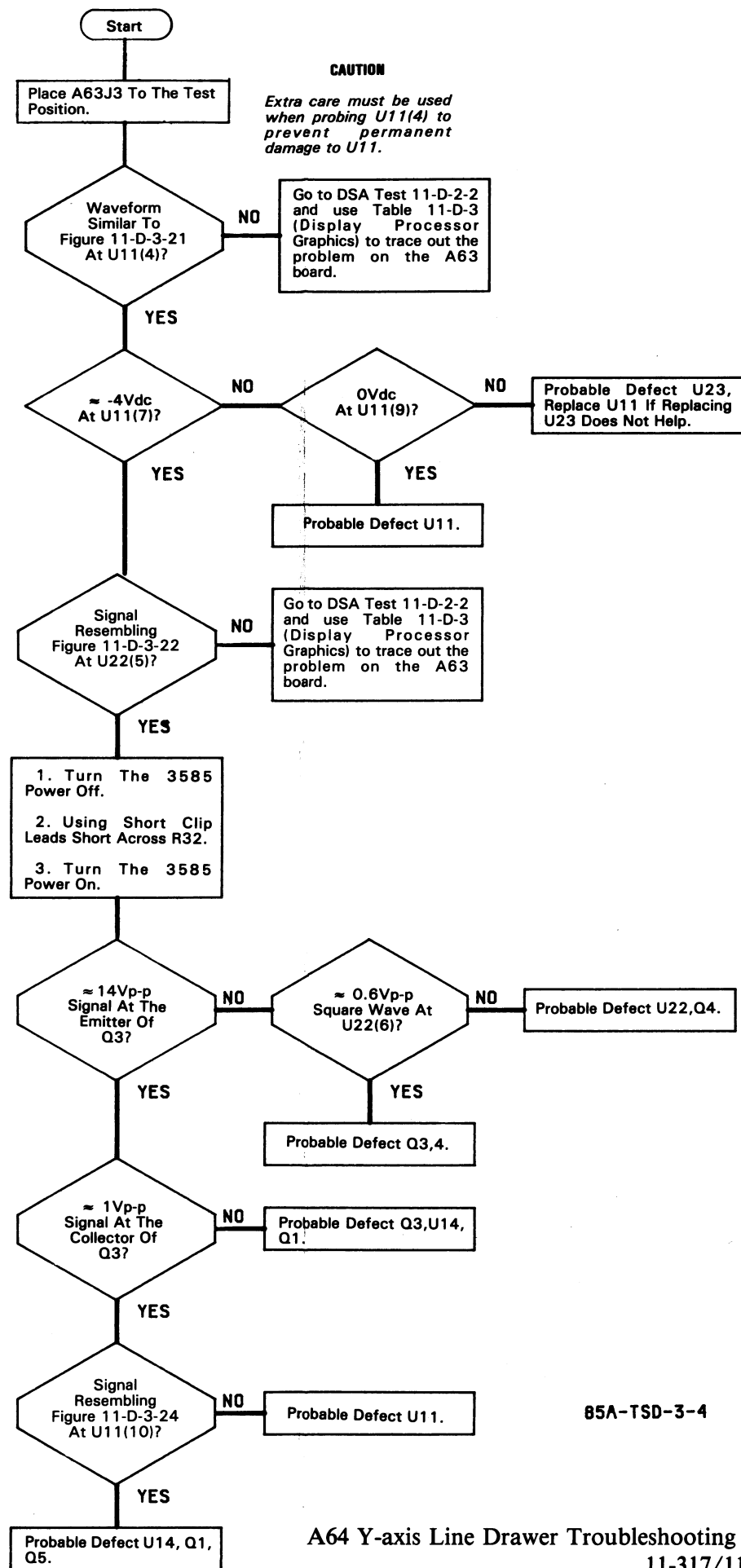


Figure 11-D-3-24



A64  
03585-66564



85A-TSD-3-4

# SERVICE GROUP D-4 XYZ AMPLIFIERS

**Board No. A67**  
**Part Number 03585-66567**

**INDEX:**

Title	Page No.
A67 X and Y-axis Deflection Amplifiers . . . . .	11-320
A67 Z-axis Amplifiers . . . . .	11-320
A67 100V Regulator . . . . .	11-320
A67 High Voltage Oscillator . . . . .	11-320
A67 CRT Adjustments . . . . .	11-320
CRT Replacement Procedures . . . . .	11-320

**ADJUSTMENTS:**

Component	Adjusted Parameter	Page No.
A67R1	Trace Align	5-11
A67R2	Orthogonality	5-11
A67R3	Pattern	5-11
A67R6	Intensity Limit	5-10
A67R38	100V Regulator	5-10
A67R46	High Voltage ( - 4kV)	5-10
A67R54	X-gain	5-11
A67R59	X-position	5-11
A67R80	Y-gain	5-11
A67R85	Y-position	5-11
A67R105	Flood gun grid	5-10
A67R116	Graticule Illumination Maximum	5-10
A65R13	Focus Limit	5-10

**TROUBLESHOOTING NOTES:**



*Voltages in excess of 150Vdc are exposed on the A67 board. Contact with these voltages can cause physical injury or death.*

*The A65 board contains voltages in excess of - 4kV. Physical injury or death can result if contact is made with the A65 board even when the line switch is OFF.*

## WARNING

*When disconnecting the CRT's anode cable (red) the full – 18kV can remain on the cable even when the LINE switch is set to OFF. Physical injury or death may result if either end of this cable is contacted. Always ground the ends of this cable immediately after disconnecting it.*

1. Due to the difficulty of troubleshooting the High Voltage board (A65), it is recommended that the entire board be replaced. The part number for the entire board, including cables and high voltage multiplier is 03585-64201.

### **A67 X and Y-axis Deflection Amplifiers.**

1. Check the input signal for Q14, Q24 (see schematic for oscilloscope photographs).
2. Check for a signal identical to the input on the emitters of Q14A, 24B. A lack of signal may be due to the current sources CR20, 23; Q15, 25 or Q14, 24.
3. If no signal is present at the X1, X2 or Y1, Y2 outputs then use the schematic to check the dc voltages within the Deflection Amplifiers. Especially check the base-to-emitter drops of the transistors.

### **A67 Z-axis Amplifier.**

1. Check the input signal for Q2 (see schematic for oscilloscope photographs).
2. Set the front panel INTENSITY control at 10 o'clock and check for  $\approx 0.12V_{p-p}$  square wave at the emitter of Q1.
3. Vary the INTENSITY control, this should cause the dc level of the square wave to vary.
4. If no signal is present at TP5 then place J11 in the "Test" position. Adjust the INTENSITY control so that the base of Q3 equals – 7Vdc. Now use the schematic to check the dc voltage conditions on Q1, 5-8.

### **100V Regulator.**

1. Check for  $\geq 115V$  at the collector of Q11. F1 on the A75 Power Supply Control Board, may be removed to check the input voltage if Q11 is suspected of loading.
2. Using the voltages given on the schematic check U3, CR10, 11, 12 and Q11, 12. Note that the voltage may be checked relative if the voltage at TP2 is wrong. If the output voltage is low, suspect CR12 or C46 of being shorted.

### **A67 High Voltage Oscillator.**

1. Check the 18V supply fuse A67F1. If it is open, check to see if Q35 or CR27 is shorted. If Q35 and CR27 are OK, replace the fuse and continue.
2. Is  $U2(6) \geq 7V_{dc}$ .
  - a. If the voltage is  $\geq 7V_{dc}$ , check Q13. If Q13 is good replace the A65 board.
  - b. If the voltage is  $< 7V_{dc}$  or negative go to step 3.
3. Check the anode of CR13 for 38Vdc. A lack of the proper voltage indicates a problem with CR13, 29, Q4 or the switch.

4. Check U2(3) for 0Vdc. If U2(3) is not equal to 0Vdc check for  $\approx 0Vdc$  at the anode of CR14.
  - a.  $\approx 0Vdc$  at the anode of CR14 indicates a probable defect of U2.
  - b. A voltage at the anode of CR14 indicates problems on the A65 board.

### A67 CRT Adjustments.

The adjustments for the CRT are relatively minor circuits composed of variable resistors and zener diodes. Use the schematic and the listed voltages to troubleshoot these circuits.

### CRT Replacement Procedure.

- a. Unplug ac power from the 3585 and remove the top cover.
- b. Remove the plastic trim strips from the top and left side of the instruments front frame.
- c. Locate and remove the two screws beneath the bottom edge of the CRT bezel (see Figure 11-D-4-1).
- d. Remove the inner portion of the CRT bezel and the plastic faceplate over the CRT face.
- e. Remove the first, third and fifth screws from the top of the instrument's front frame.
- f. Apply gentle pressure to the back of the front panel. The top of the front panel will swing out toward you.
- g. Remove the ribbon cable from the back of the front panel and set the front panel aside.
- h. Place the instrument on its right side and remove the bottom cover.

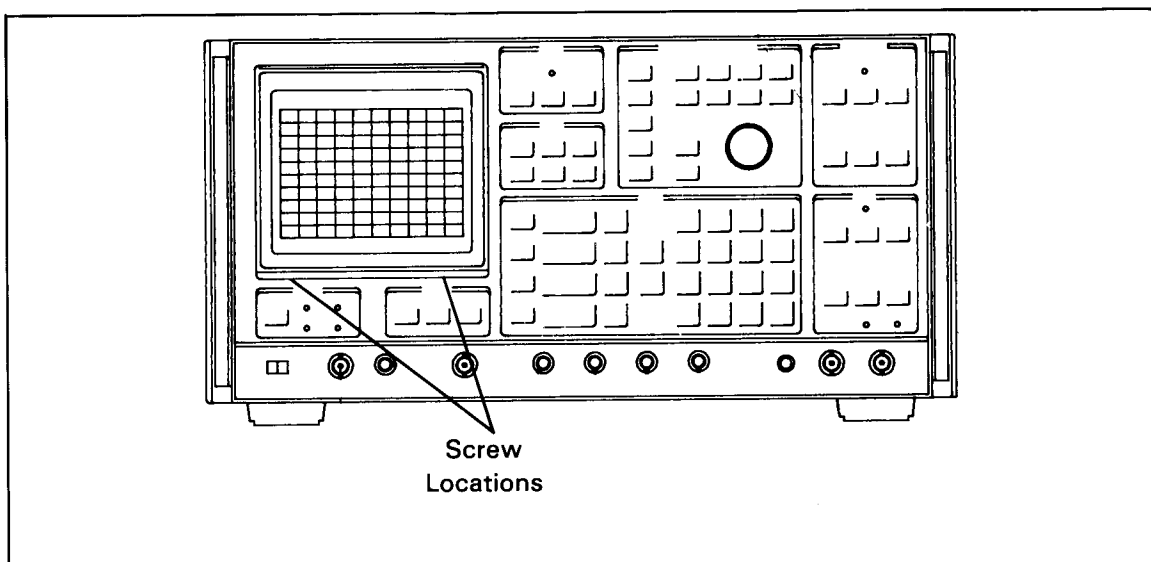


Figure 11-D-4-1. CRT Bezel Screw Location

**WARNING**

*The CRT anode retains a large portion of the – 18kV voltage even when the LINE voltage is OFF. Physical injury or death can result if this voltage is contacted.*

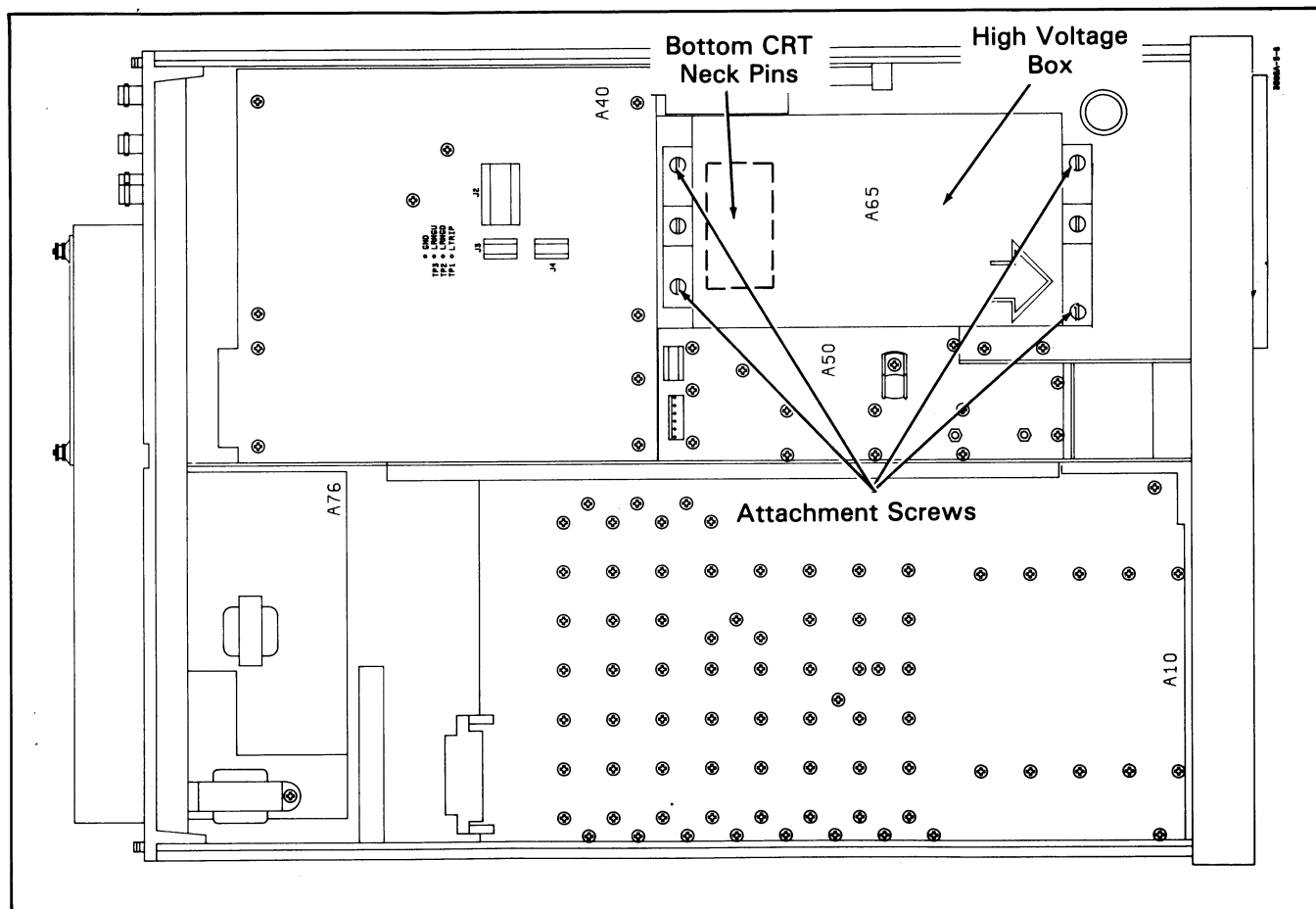
- i. Disconnect the CRT anode (red) cable. As soon as it is disconnected touch the end connected to the CRT to the chassis. This will short the static charge on the CRT to ground.

**WARNING**

*Do not at any time touch the screwdriver shaft while discharging the high voltage supply. Serious physical injury or death may result.*

- j. Place the metal shaft of an insulated screwdriver against the instruments frame. CAREFULLY place the end of the screwdriver inside the High Voltage. Supply portion of the CRT anode cable until it reaches the bottom of the cable connector. Hold the screwdriver in place for 10 seconds.

- k. Loosen the four screws shown in Figure 11-D-4-2. Swing the High Voltage box away so that the bottom CRT neck pins are exposed.



**Figure 11-D-4-3. High Voltage Box Removal**

- l. Remove the Bottom CRT neck pins.
- m. Remove the Top CRT neck pins.
- n. Remove the protective plastic cover over the A67 board (see Figure 11-D-4-3).
- o. Remove the two screws which hold the CRT neck clamp (see Figure 11-D-4-3).
- p. Remove the four screws which hold the CRT bezel. Two of the screws are located on the left side of the front frame, one on the top of the front frame and one below the lower right corner of the CRT bezel.
- q. Carefully slide about 1/3 of the CRT out the front frame. Disconnect the rear CRT connector. The CRT is now free to remove from the instrument.
- r. Remove the CRT bezel from the CRT shield. The CRT bezel is friction fit onto the CRT shield, there are no attachment screws.
- s. Remove the CRT from the CRT shield and replace it.

**NOTE**

*When replacing the CRT be sure that the foam rubber ring is placed in the proper position near the CRT rear connector.*

**NOTE**

*After the CRT is installed in the instrument remember to reconnect the black wire connected to the CRT shield to the CRT bezel mounting screw in the lower right corner.*

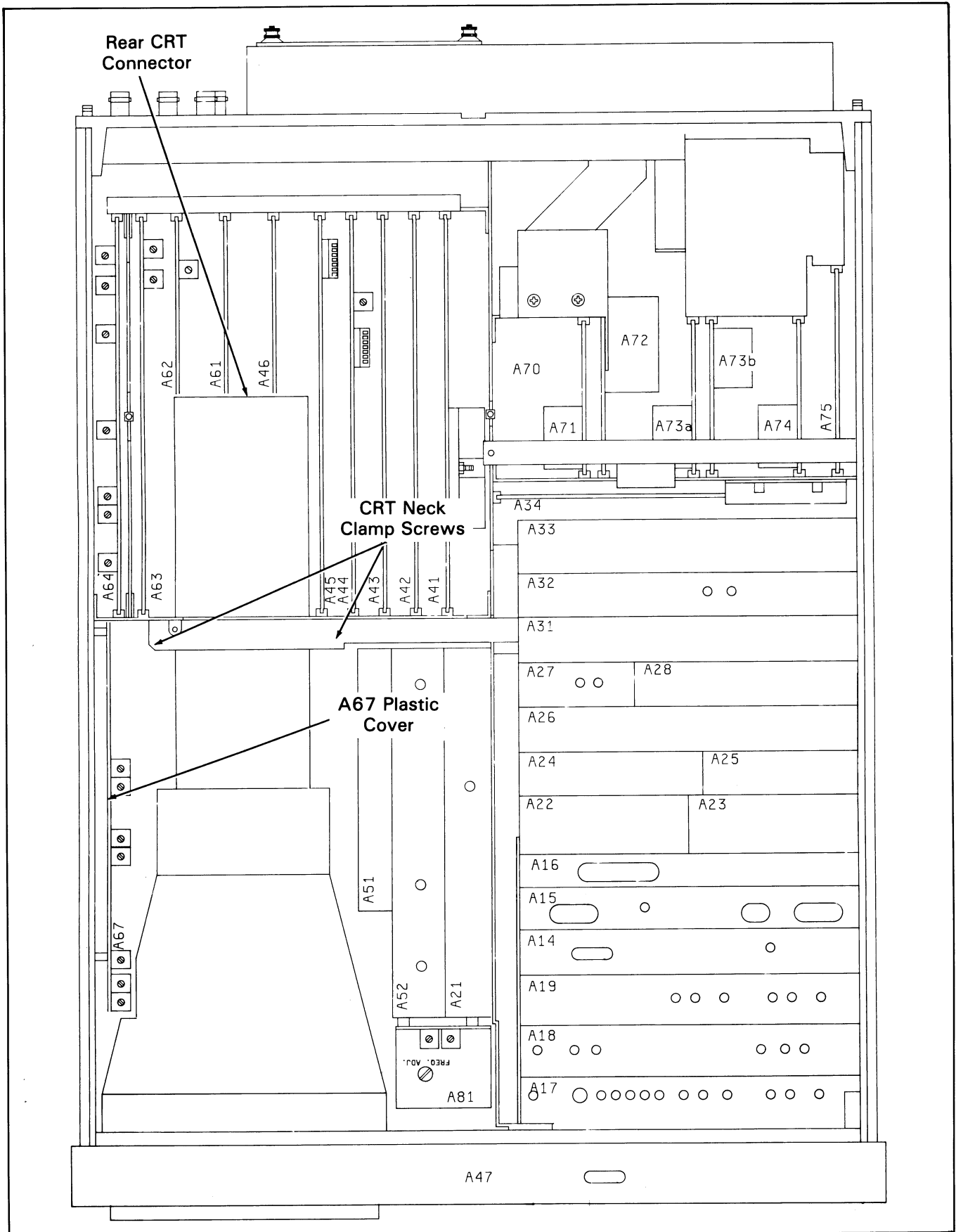
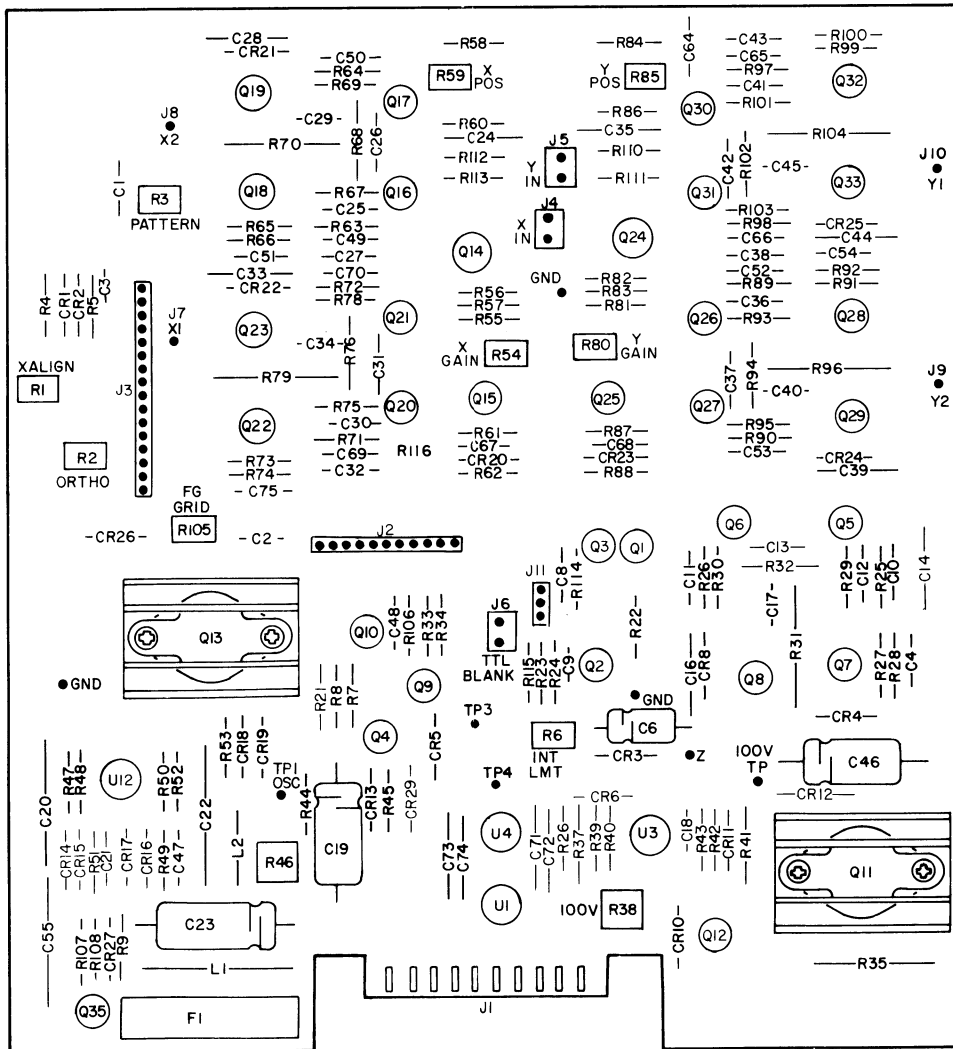


Figure 11-D-4-3. CRT Removal - Top View



3585-B-3

A67  
03585-66567



# SERVICE GROUP E TRACKING GENERATOR

**Board No. A51-3**

**Part Number 03585-66551 thru -66553**

**INDEX:**

Title	Page No.
Main Tracking Generator Troubleshooting Tree.....	11-329/11-330
A52 Mixer and Output Amplifier Troubleshooting Tree.....	11-331/11-332
A53 100.35 MHz Oscillator Troubleshooting Tree.....	11-333

**EQUIPMENT REQUIRED:**

Instrument	Required Characteristics	Recommended Model No.
Digital Voltmeter	4½ Digits dc Accuracy $\pm 0.05\% \pm 3$ Digits	-hp- 3466A
Oscilloscope	Bandwidth dc to 100MHz Vertical Sensitivity 0.005V/div.	-hp- 1740A
Spectrum Analyzer	Freq. Range 0.1 to 200MHz Amplitude Accuracy $\pm 3$ dB	-hp- 8558B
Resistor Probe	20:1 Resistive Divider, 1K $\Omega$ Resistance When Terminated in 50 $\Omega$ .	-hp- 10020A
Digital Signature Analyzer		-hp- 5004A

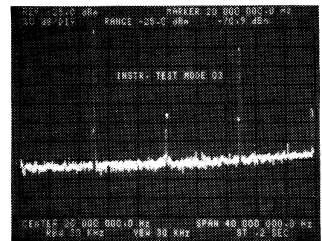
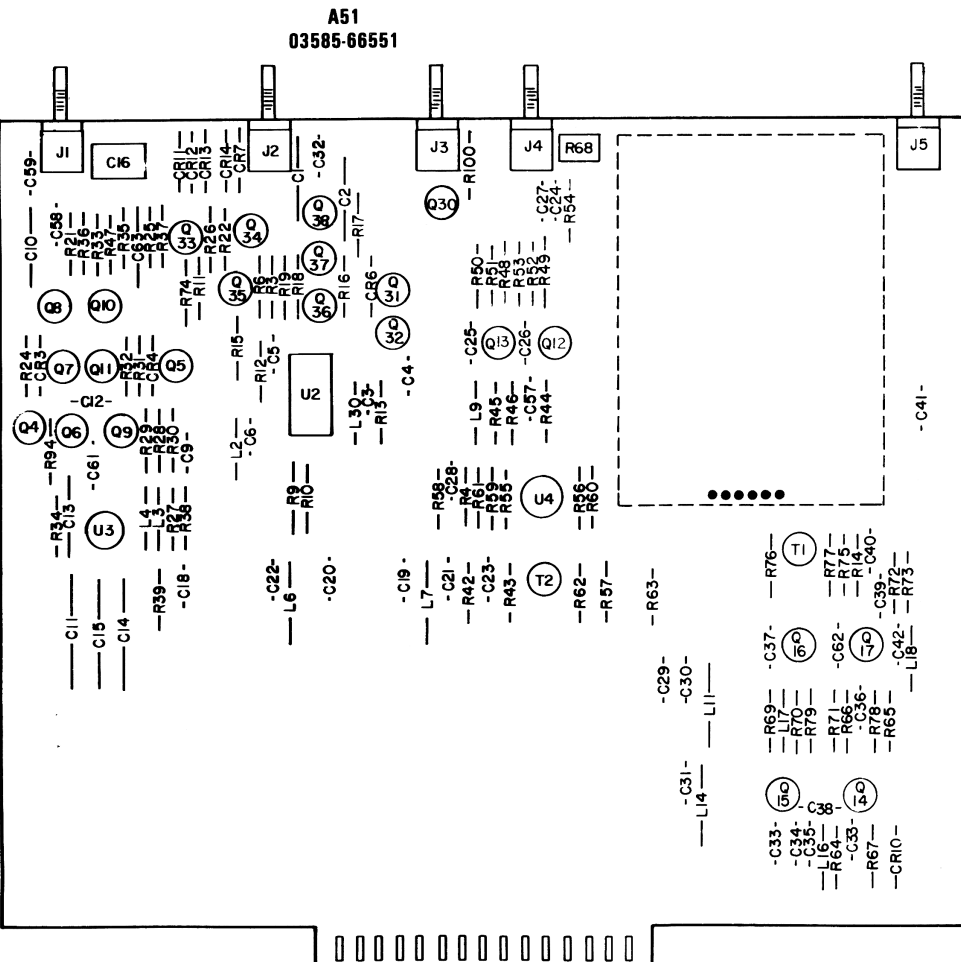
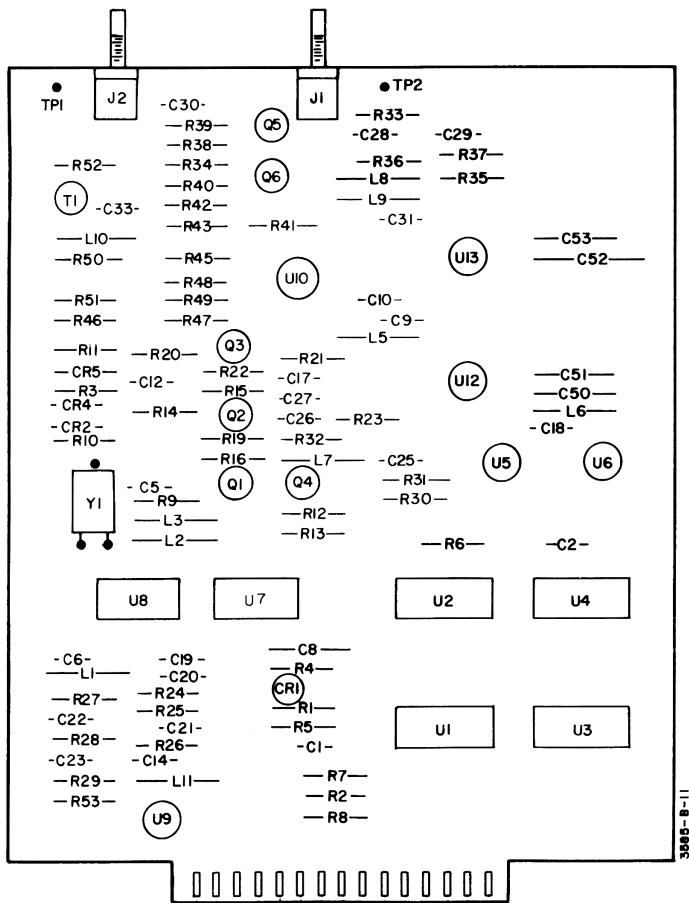


Figure 11-E-1. Recall 603

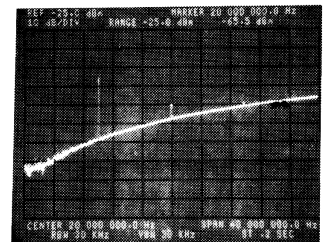


Figure 11-E-2. Output At A52J2

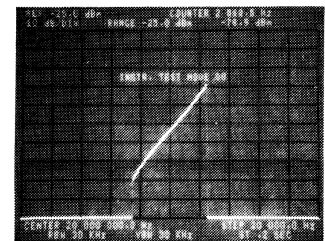


Figure 11-E-3. Course DC

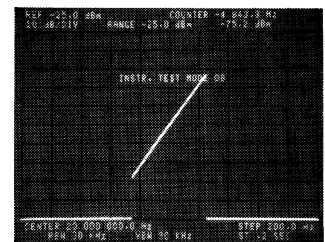


Figure 11-E-4. Fine DAC

Set  
Genera  
The  
Clockw  
tion.

1. C  
ing Ge  
Output  
minate  
2. Er  
dB/DI  
Range  
Refer

1. Se  
The M  
On The  
2. Er  
Offse  
Enter

1. Di  
puts T  
Channe  
2. Er  
Re  
Ins

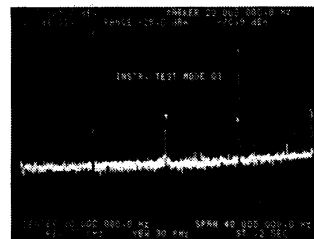


Figure 11-E-1. Recall 603

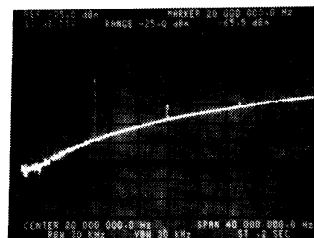


Figure 11-E-2. Output At A52J2

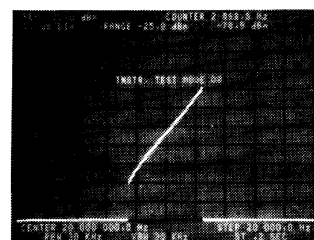


Figure 11-E-3. Course DC

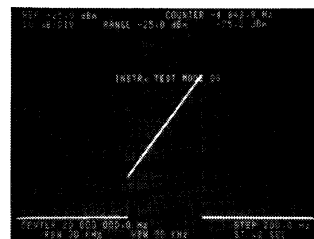
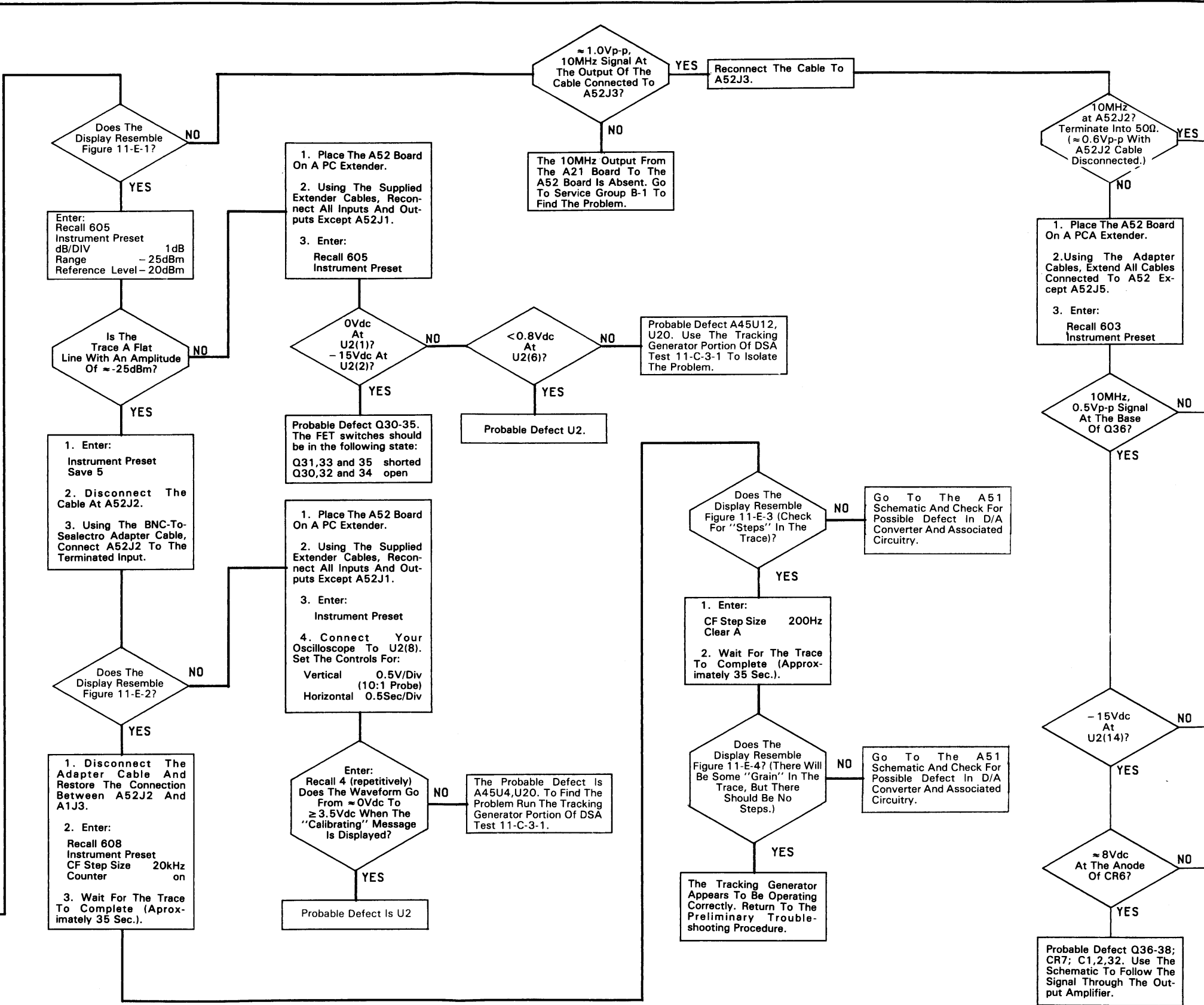
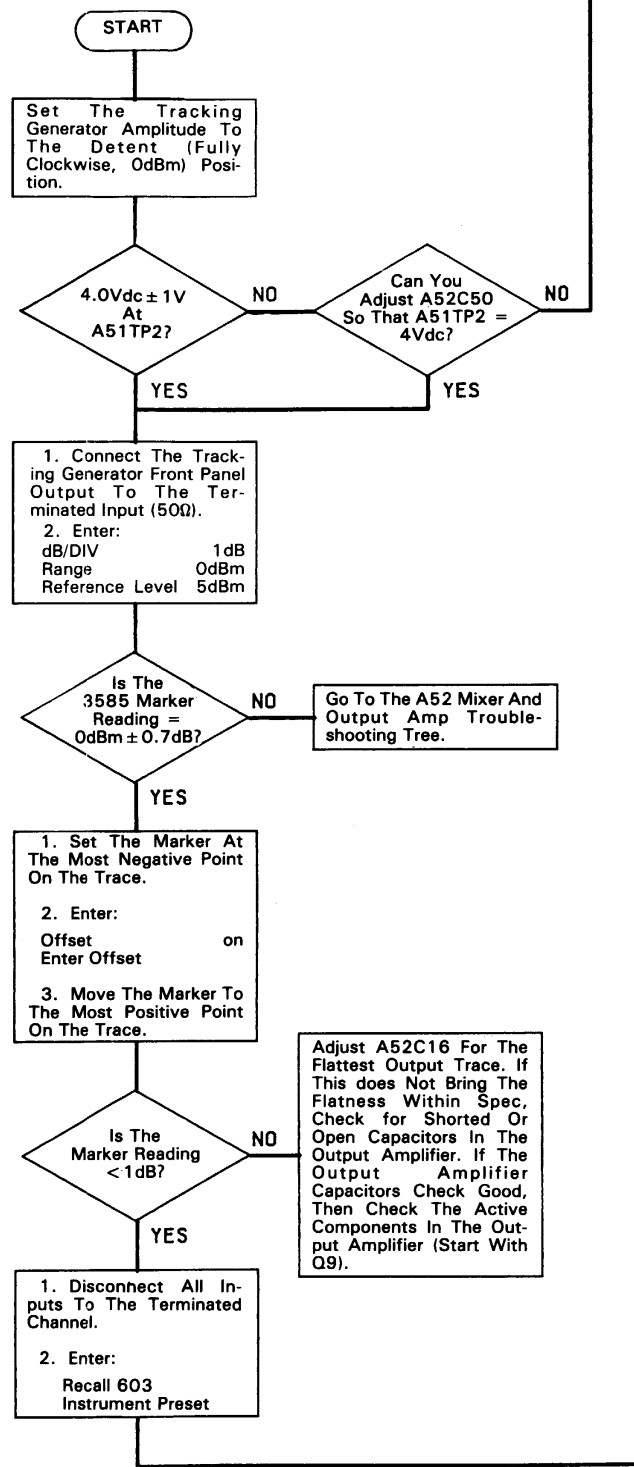
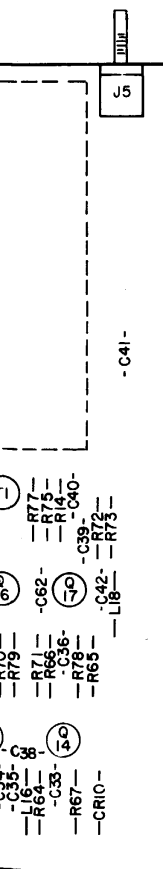
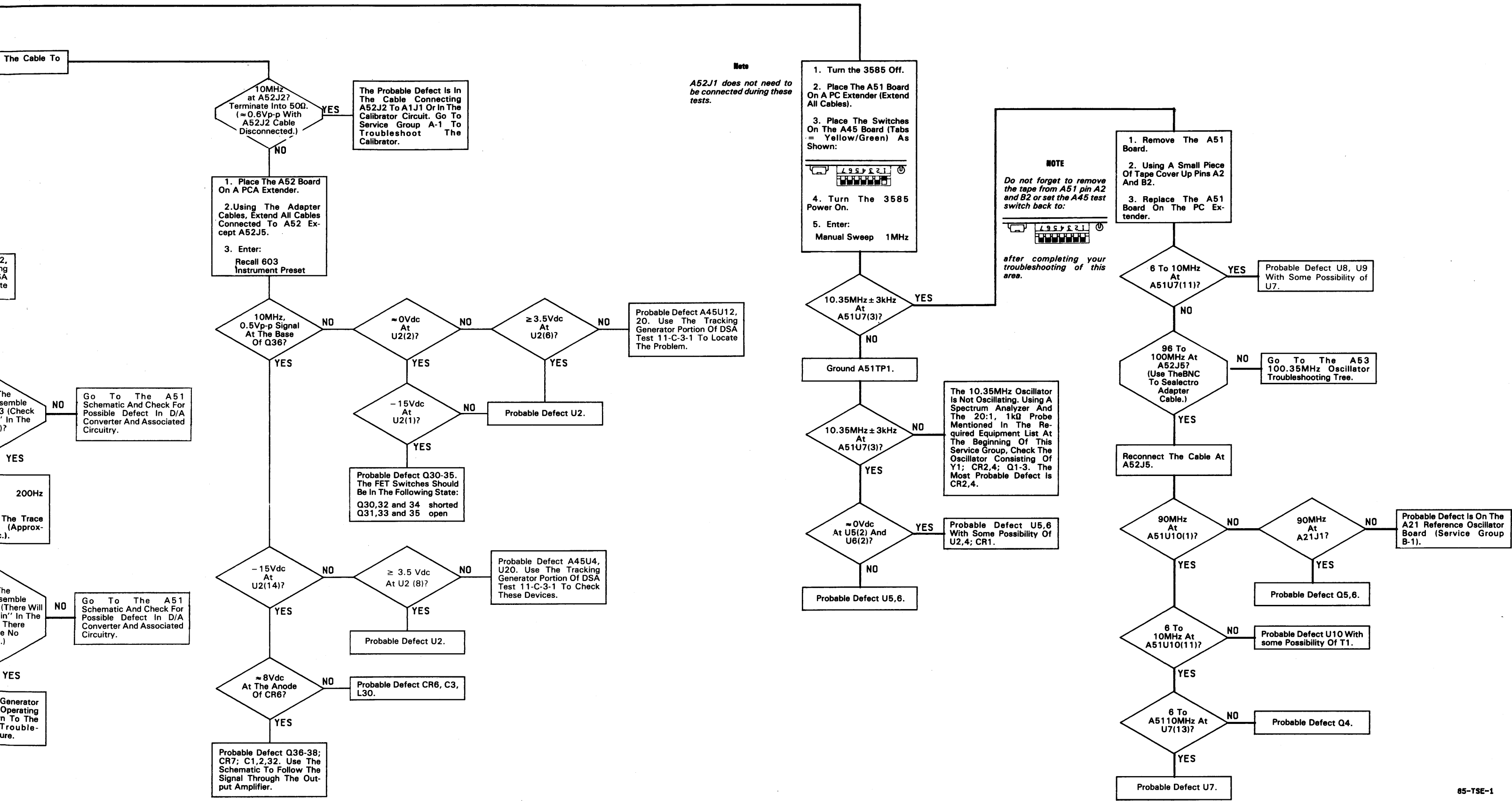
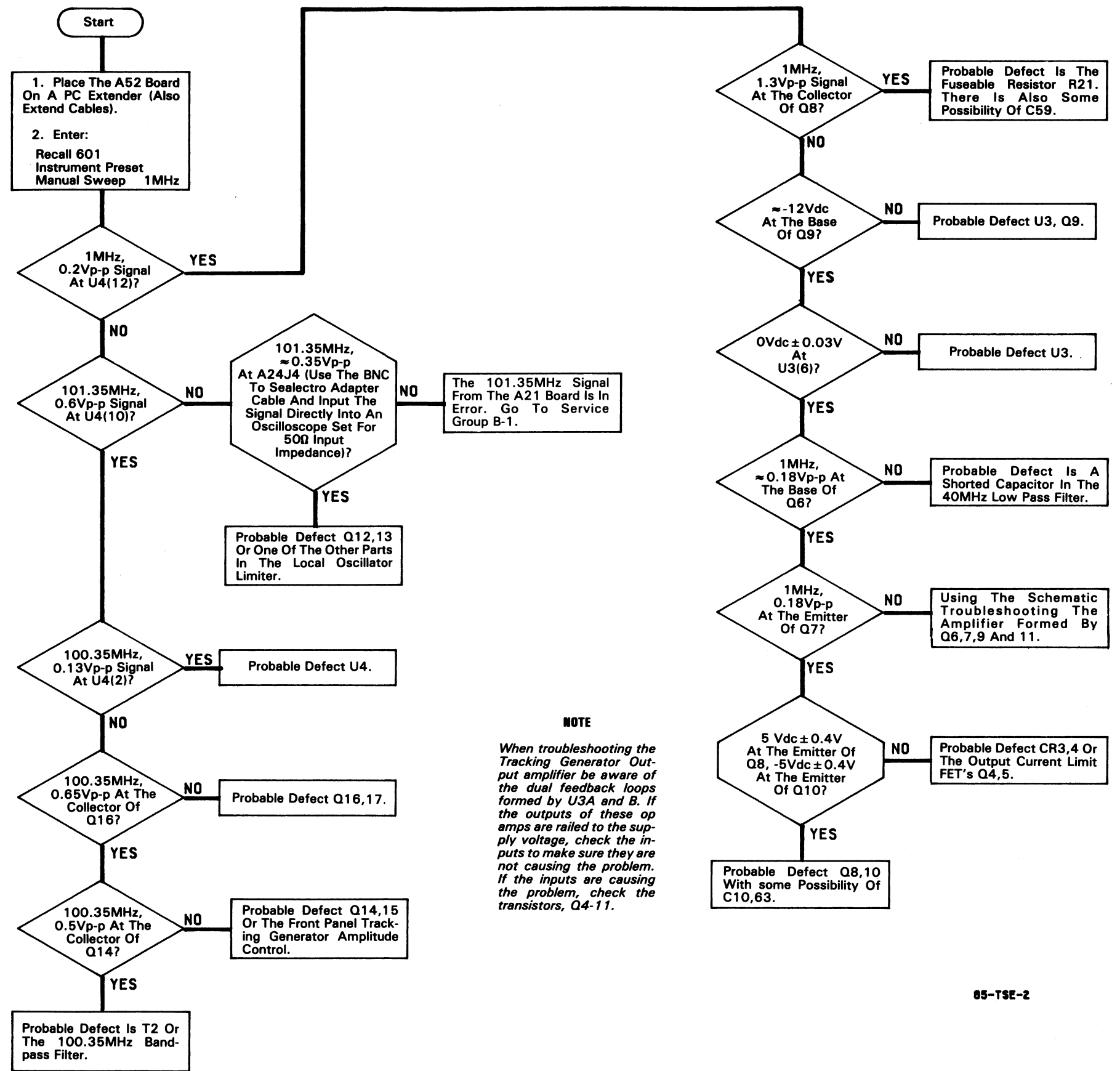
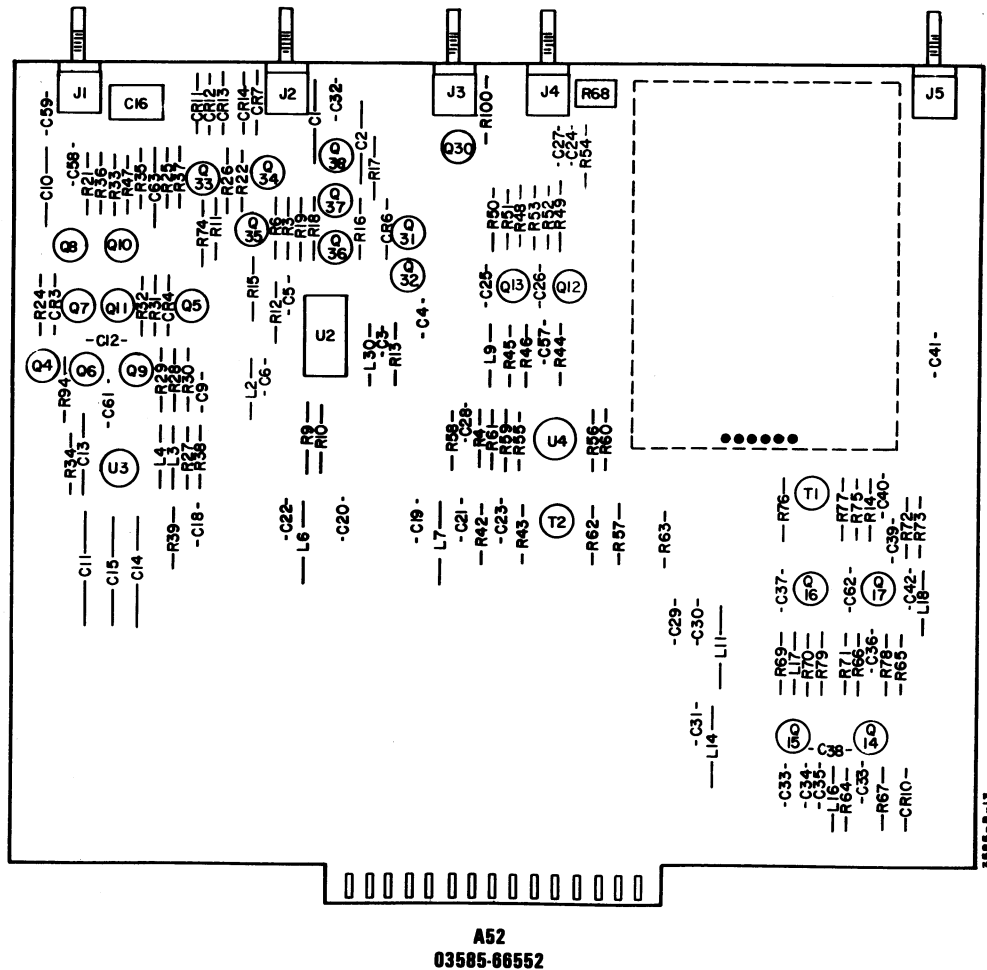
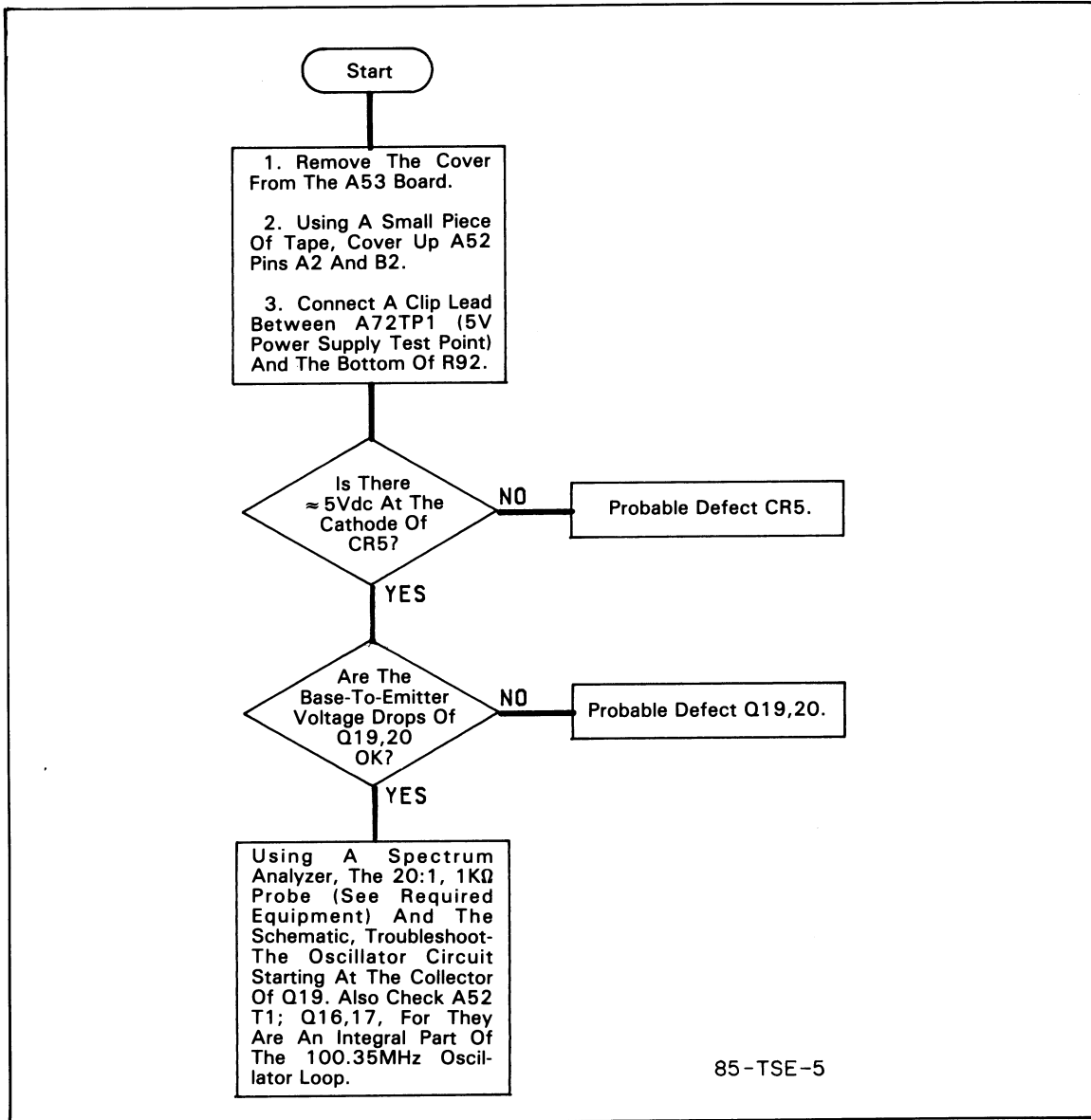


Figure 11-E-4. Fine DAC

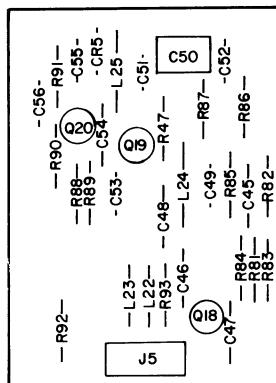




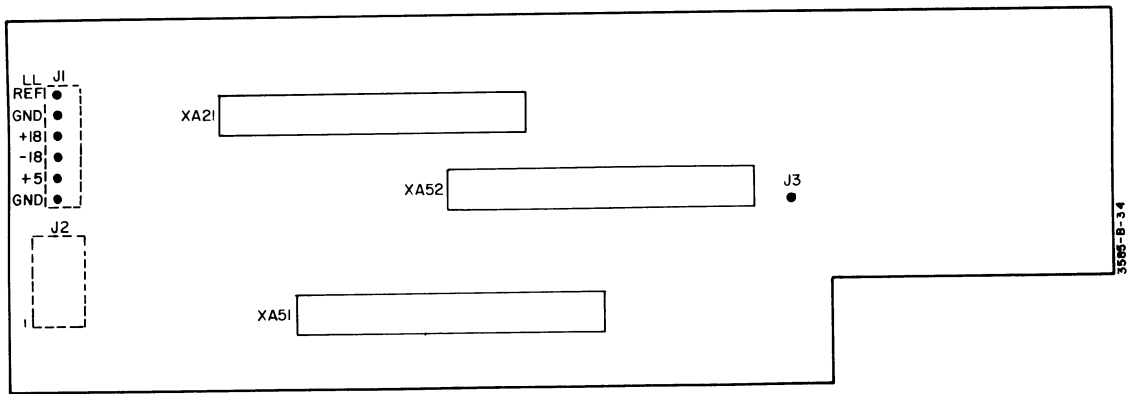




**A53 100.35MHz Oscillator Troubleshooting Tree**



**A53**  
03585-66553



A50  
03585-66550

# SERVICE GROUP F

## HP-IB

**Board Number A44**

**Part Number 03585-66544**

### INDEX:

Title	Page No.
HP-IB Troubleshooting Procedure.....	11-336
HP-IB Calculator Test.....	11-347
DSA Test 1 Problem Table (Table 11-F-1).....	11-337/11-338
DSA Test 2 Signature Table (Table 11-F-2).....	11-345
Probable Defects For Interface Circuitry Inputs (Table 11-F-3).....	11-346
HP-IB Calculator Test Error Definitions (Table 11-F-4).....	11-347
HP-IB Check Program Listing for the 9825A Calculator (Table 11-F-5).....	11-348

### ADJUSTMENTS:

Component	Adjusted Parameter	Paragraph Location
A44R9	Backgate Bias	5-47

### TROUBLESHOOTING NOTES:

None



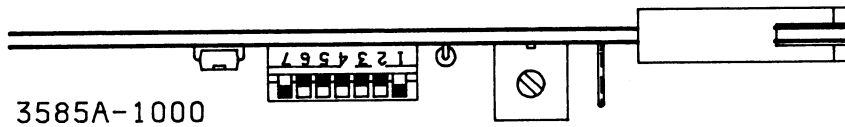
**TROUBLESHOOTING NOTES:**

None

**HP-IB Troubleshooting Procedure.**

A. Preparation for test.

1. Turn the 3585's power off.
2. Remove the PC hold down bar from the Digital PC board section.
3. Remove the Processor board (A41), I/O board (A45) and Display Processor board (A63).
4. Set the address switches on the HP-IB board (A44) to:



5. Remove any HP-IB connections from the 3585.
6. Measure the dc voltage at TP5, it should equal ( $\pm 0.2V$ ) the voltage marked on U16. If it does not, adjust R9.

B. Momentarily short TP1 to ground.

1. If the LED on the HP-IB board is blinking, go to the HP-IB Calculator Test.
2. If the LED is not blinking, go to step C.

C. DSA Test 1.

1. Turn the instrument off.
2. Connect the Signature Analyzer as follows:

START and STOP.....A44TP7  
 CLOCK..... A44TP8  
 GND.....A44 "GND" Test Point

3. Set the Signature Analyzer controls as follows:

START ..... / (out)  
 STOP ..... \ (in)  
 CLOCK..... / (out)  
 HOLD..... off (out)  
 SELF TEST..... off (out)

4. Turn the 3585A (and Signature Analyzer) on.

5. Momentarily short TP1 to ground.
6. Touch the Signature Analyzer probe to pin A38.
  - a. If the signature reads 9C81 the test ROM is outputting the correct test program. The LED may be faulty. To check the LED, place the probe on U5(6). If the probe blinks the LED is defective. If it does not blink, go to step D.
  - b. If the signatures are incorrect, something is loading the Data Bus. Probable Defect is U29,10 or 11 with some possibility of CR1,R14,U30,14,15,16,5,4,9,12. See the schematic to find out which components are connected to the particular line that has the incorrect signature.

**Table 11-F-1. DSA Test 1 Problem Table**

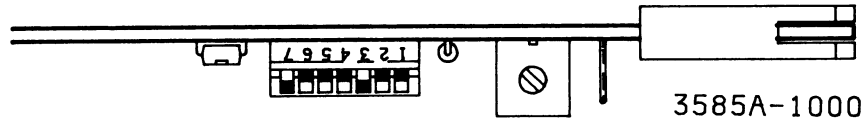
To use this table, find the Signature that is displayed on the Signature Analyzer in Column A. Column B gives a description of the fault. Now return to DSA Test 2 (step D) and check the points listed in Column C.

If there is no signature in Column A to match your signature, go to step E.

A Signature	B Description Of Faulty Node	C Possible Faulty Component
9515	U16 DC 0	U16
5159	U16 DC 0	U16
159A	U16 DC 5	U16,U28, Interrupt Circuit
59A4	U16 DC 5	U16,U28, Interrupt Circuit
6929	U16 DC 4	U16,39,38
29F3	U16 DC1; DC 2; DC 6;	U16,27
70FC	U16 DC 1 shorted to ground.	U16,27
32HF	U16 DC 2 shorted to ground.	U16,27
29F3	U16 DC 6 shorted to ground.	U16,27
70HA	U16 DC 1; DC 2; DC 6;	U16,27
3696	U16 DC 1; DC 2; DC 6;	U16,27
ASC1	U-15 to Data Bus or Device Select to U-15, U 3 9 .	U15,39
H6PC	Received wrong data thru bus; Data Latch U-10, 11.	U10,11
6PCP	Received wrong data thru Bus Control Latch.	U30,37
PCP5	Received wrong data thru Data Latch U-36.	U36,29
UP64	Error in EOI line.	U34,27,19,11,12
593A	Error in ATN line.	U28,35,20,11,12
4PC7	Error in REN line.	U28,35,20,11,12
H5H8	Same as H6PC; U-9.	U9
5H82	Same as PCP5; U-36.	U36
0AU9	Error in REMOTE line; not necessarily in "REN".	U28,35,20,11,12
U9H5	Same as 6PCP.	U30,37
66PO H9C8	Same as H6PC;U-10,11.	U10,11
PFHF 9C81	No ATN interrupt.	U28,35,20,11,12

D. DSA Test 2 — General DSA Test.

1. Set the address switches as follows:



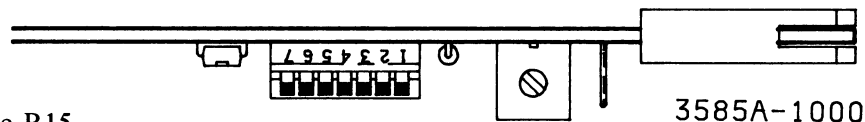
2. Leave the START, STOP and CLOCK probes and controls in the same position as step C.
3. Momentarily short TP1 to ground.
4. Check the following signatures:

Check Point	Signature
U16(1)	FUU5
Pin A38	UHC8

- a. If either signature checks bad, it indicates the test program is in error. Go to step E.
- b. If both signatures check OK, go to Table 11-F-2 to locate the faulty component.

E. DSA Test 3 — Processor and ROM Test.

1. Set the address switches as follows:



2. Remove R15.
3. Check the dc voltage at U16(29).
  - a. If U16(29) is 3.5-5Vdc, go to step E-4.
  - b. If U16(29) is  $\leq 3.5$ Vdc, the Nanoprocessor is constantly being interrupted. Troubleshooting the interrupt circuit (U1,2,3,4,13) with Figure 11-F-2. The TTL levels are shown for each gate for the set-up conditions of DSA Test 3.
4. Connect the oscilloscope to TP4. Check for a  $\approx 500$ Hz square wave,  $\geq 3.5$ Vp-p.
  - a. If the signal checks OK, go to step E-5.
  - b. If the signal is not present at TP4, the Probable Defect is U16.
5. Connect the Signature Analyzer as follows:

START and STOP.....A44TP4  
 CLOCK.....A44TP8  
 GND.....A44 "GND" Test Point

Table 11-F-2. DSA Test 2 Signature Table

Part 1					Part 2						
Use the set-up conditions described in Step D.					Connect the Signature Analyzer as follows:						
+ 5 V (pin A38) = UHC8 U16 (1) = FUU5					START and STOP                      A44 U16(9) CLOCK                                      A44U16(16) GND                                         A44 "GND" Test Point						
<b>U5 Pin</b>	<b>Signature</b>	<b>U16 Pin</b>	<b>Signature</b>	<b>U22 Pin</b>	<b>Signature</b>	<b>U9 Pin</b>	<b>Signature</b>	<b>U28 Pin</b>	<b>Signature</b>	<b>U34 Pin</b>	<b>Signature</b>
6	424H	1	FUU5	3	P699	2	86U5	5	980P	1	P910
9	P699	2	5A86	4	1C21	5	37AC	7	733P	2	P910
		3	33P6	9	PH40	6	PAU3	9	97H6	3	P913
<b>U9 Pin</b>	<b>Signature</b>	4	1U6H	10	2847	9	CH5P	10	0003	4	0003
		5	4HU6			12	70HP			5	F8FF
2	9818	6	F615	<b>U23 Pin</b>	<b>Signature</b>	15	OP1C	<b>U32 Pin</b>	<b>Signature</b>	6	F8FU
5	1P41	7	4470	4	H417	16	003F	1	H966	7	F8FU
6	4221	8	0000	7	3H61	19	01F3	2	H966	9	919A
9	682A	9	4FU4	9	POC5			3	H966	10	919A
12	587U	12	8AHU	12	7F68	<b>U10 Pin</b>	<b>Signature</b>	4,12	0003	11	9199
15	15P8	13	CC95			2	8PFC	5	8PFC	12,13	4823
16	FAC5	14	1C5H	<b>U24 Pin</b>	<b>Signature</b>	3	919A	6	8PFC	14	4823
19	U2PU	15	H47U	7	14FP	5	H966	7	8PFC	15	4823
		16	7039	9	6165	6	F8FU	9	C560		
<b>U12 Pin</b>	<b>Signature</b>	17	0000	10	91U8	10	4823	10	C560	<b>U35 Pin</b>	<b>Signature</b>
		18	187A	11	H519	11	043P	11	C560	1	3395
3	CUP2	19	810A	12	9U3A	13	3395	13	043P	2	3395
6	C306	20	14HH	13	7C13	14	C560	14	043P	3	3395
11	F377	21	P3C1	14	44AF			15	043P	4,12	0000
14	1A00	22	UU63	15	P6A8	<b>U11 Pin</b>	<b>Signature</b>			5	733P
		23	POU1			2	3H8P	<b>U33 Pin</b>	<b>Signature</b>	6	733P
<b>U15 Pin</b>	<b>Signature</b>	24	6HP4	<b>U29 Pin</b>	<b>Signature</b>	5	434C	1	434C	9	97H6
		25	A4PC	1	H519	6	97H6	2	434C	10	97H6
1	81HO	26	AC6A	2	4413	10	P910	3	434C	11	97H6
2	UHC8	28	0000	4	414A	11	33A9	4,12	0003	13	980P
3	14HH	29	UHC8	6	C5AH	13	980P	5	3H8P	14	980P
4	81HO	30	0000	8	7CPO	14	3256	6	3H8P	15	980P
5	UHC8	31	980F	12	FO20			7	3H8P		
6	UHC8	32	7UPO	14	3PA6	<b>U21 Pin</b>	<b>Signature</b>	9	33A9		
8	PC31	33	UHC8	16	C5HO	1,12	7CC6	10	33A9		
9	UHC8	34	UHC8	18	7HUA	2, 3	4823	11	33A9		
10	81HO	35	F7UU	19	H519	4	0003	13	3256		
12	0562	36	7UUC			5	3396	14	3256		
13	0562	37	38CU			13	4823	15	3256		
		39	UHC8			<b>U27 Pin</b>	<b>Signature</b>				
						5	9199				
						7	F8FF				
						9	P913				
						11	4823				

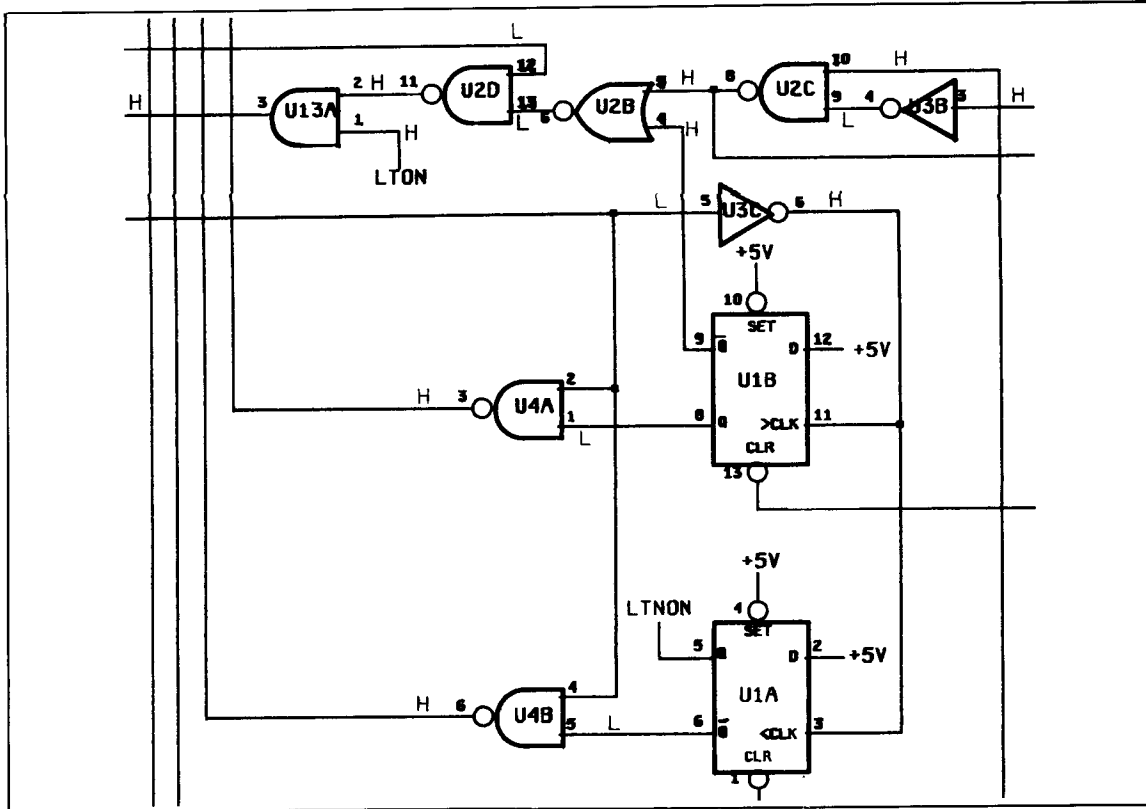


Figure 11-F-2a. Interface Circuitry Levels

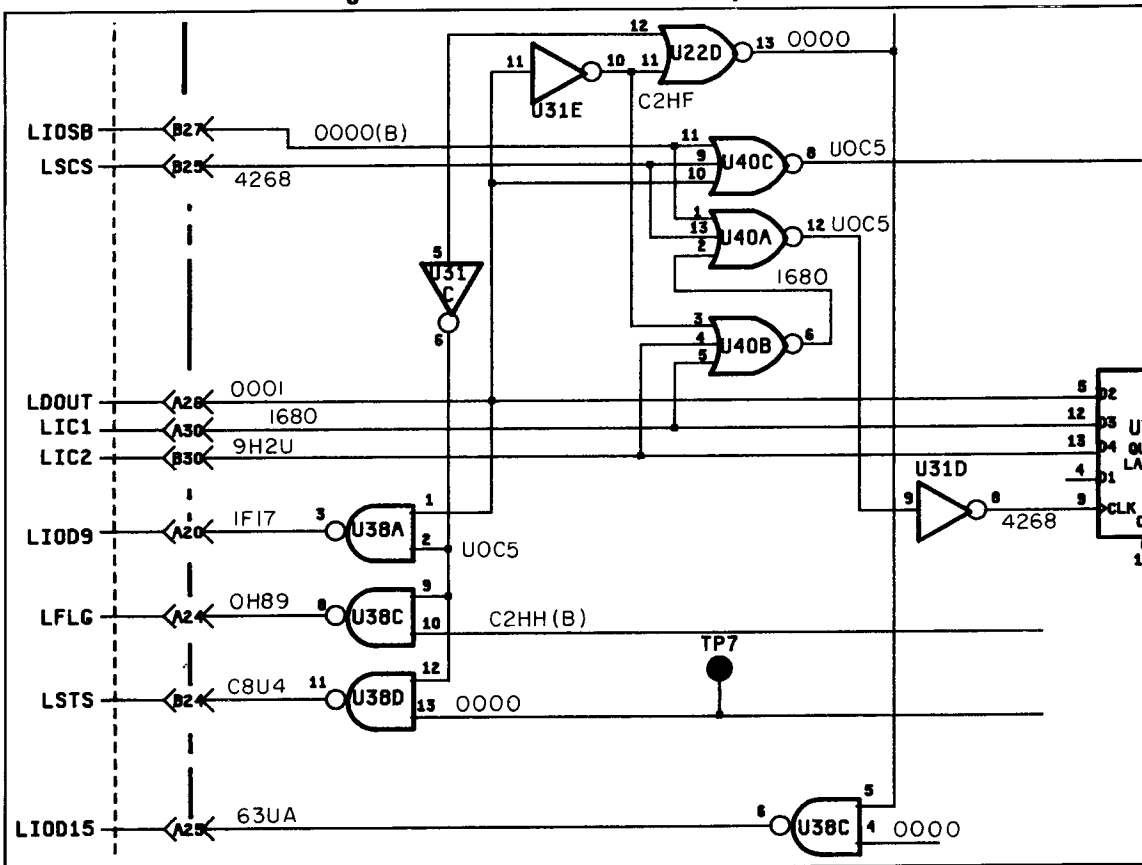


Figure 11-F-2b. Interface Circuitry Signatures

6. Set the Signature Analyzer controls as follows:

START ..... / (out)  
 STOP ..... \ (in)  
 CLOCK ..... \ (in)  
 HOLD ..... off (out)  
 SELF TEST ..... off (out)

7. Momentarily short TP1 to ground.

8. Check for the following signatures at U16:

U16 Pin	Signature
1	C21A
2	HA07
3	HOAA
4	PO30
5	4442
6	4U2A
7	0772
8	9635
9	1734
10	8P54
11	7A70
12-16	7A70
17	0000
18-25	7A70
26	0000
28	0000
30	0000

- a. If the signatures are correct, go to step E-9.  
 b. If the signatures are incorrect, the Probable Defect is U16 or U16 being loaded by U7.

9. Check the following signatures on U7:

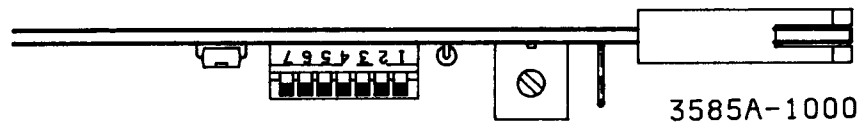
U7 Pin	Signature
9	1U14
10	58CC
11	0HFC
13	9A83
14	5525
15	P9PA
16	6606
17	7035

- a. If the signatures are correct, go to step E-10.
- b. If the signatures are incorrect, the Probable Defect is U7.

10. Replace R15, then continue with step F.

F. DSA Test 4 — Data Bus Test.

1. Set the address switches to:



2. Check that U16(29) is  $\geq 3.5Vdc$ . If U29(20) is  $\leq 3.5Vdc$ , the Nanoprocessor is constantly being interrupted. Troubleshooting the interrupt circuit (U1,2,3,4,13) with Figure 11-F-2. The TTL levels are shown for each gate for the set-up conditions of DSA Test 3.

3. Connect the Signature Analyzer as follows:

START and STOP ..... A44TP2  
 CLOCK ..... A44TP6  
 GND.....A44 "GND" Test Point

4. Set the Signature Analyzer controls as follows:

START ..... (out)  
 STOP ..... (in)  
 CLOCK ..... (in)  
 HOLD.....off (out)  
 SELF TEST.....off (out)

5. Momentarily ground TP1.

6. Verify that the test set-up is correct by probing Pin A38. The signature should be UP73.

7. Check for the following signatures on U16.

U16 Pin	Signature
18	55HC
19	3342
20	U165
21	0009
22	U195
23	0008
24	UP7H
25	000P
34	UP74

- a. If the signatures are correct, go to step F-8.

- b. If the signatures are incorrect, something is loading the Data Bus. Probable Defect is U29,10 or 11 with some possibility of CR1,R14,U30,14,15,16,5,4,9,12. See the schematic to find out which components are connected to the particular line that has the incorrect signature.

8. Connect the Signature Analyzer as follows:

START and STOP.....A44TP7  
 CLOCK..... A44TP8  
 GND..... A44 "GND" Test Point

9. Set the Signature Analyzer controls as follows:

START ..... / (out)  
 STOP ..... } (in)  
 CLOCK..... / (out)  
 HOLD.....off (out)  
 SELF TEST.....off (out)

10. Momentarily ground TP1.

11. Verify that the test set-up is correct by touching the probe to Pin A38. The signature should be P545.

12. Check the following signatures on U23,24:

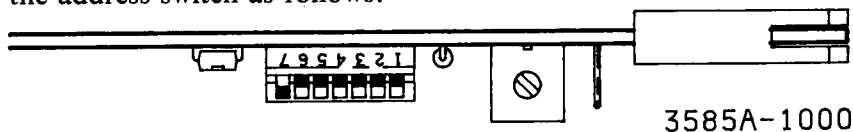
U23 Pin	Signature	U24 Pin	Signature
1	4PP7	1	3H3C
2	P545	2	5077
3	P06U	3	F203
4	P06H	4	FC24
5	P06H	5	0000
6	P545	6	P545
7	P547	7	P06H
8	0000	8	0000
9	U1PU	9	U1P7
10	U1P7	10	C7FF
11	P545	11	AU61
12	P54H	12	FHH7
13	P545	13	47OP
14	U1P7	14	6F69
15	0000	15	F1U6
16	P545	16	P545

- a. If the signatures are correct, go to step G.
- b. If the signatures are incorrect, replace the component where the incorrect signature occurred.



G. DSA Test 5 — Address Switch Test.

1. Set the address switch as follows:



2. Momentarily ground TP1.
3. Check the following:
  - The LED is off.
  - U16(29) is high ( $\geq 3.5Vdc$ )
  - U16(34) is pulsing.

If any of these three are incorrect, return to step G-2.

4. Connect the Signature Analyzer as follows:

START and STOP.....A44TP7  
 CLOCK.....A44TP8  
 GND.....A44 "GND" Test Point

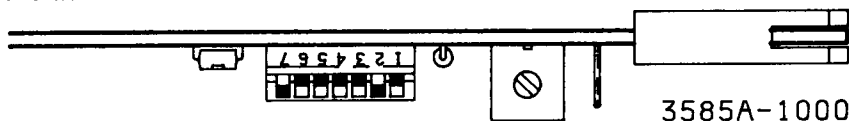
5. Set the Signature Analyzer controls as follows:

START..... / (out)  
 STOP..... \ (in)  
 CLOCK..... / (out)  
 HOLD..... off (out)  
 SELF TEST..... off (out)

6. Momentarily ground TP1.
7. Touch the probe tip to Pin A38.
  - a. If the signature is 03U9, go to step H.
  - b. If the signature is *not* 03U9, the Probable Defect is either the address switch or U6.

H. DSA Test 6 — Interrupt Circuitry Test.

1. Set the address switches as follows:



2. Connect the Signature Analyzer as follows:

START and STOP.....A44TP7  
 CLOCK.....A44TP8  
 GND.....A44 "GND" Test Point

3. Set the Signature Analyzer control as follows:

START .....	⌋ (out)
STOP .....	⌋ (in)
CLOCK .....	⌋ (out)
HOLD .....	off (out)
SELF TEST .....	off (out)

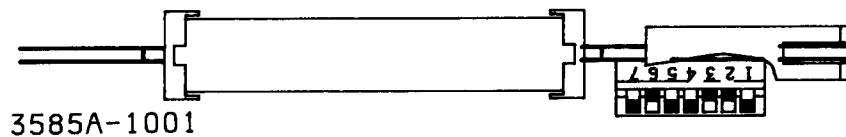
4. Momentarily ground TP1.
5. Touch the probe tip to Pin A38.
  - a. If the signature is 9FA8, the interrupt circuitry is operating properly. Return to DSA Test 2 and run it. If DSA Test 2 fails, go to step I.
  - b. If the signature is *not* 9FA8, the problem is occurring in the interrupt circuit U1,2,3,4 or 13. Return to DSA Test 3 (step E). Do steps 1, 2 and 3b. This will give you a way to check the interrupt circuitry.

I. Interface Circuitry Test.

1. Turn the 3585 Power off.
2. Replace the A41, 45 and 63 boards in the card nest. (Leave the HP-IB board on the PC extender.)
3. Set the switches on the A44 board to:



4. Set the switches on the A45 board to:



5. Connect the Signature Analyzer as follows:

START and STOP .....	A45TP1
CLOCK .....	A45TP2
GND .....	A45 "GND" Test Point

6. Set the Signature Analyzer controls as follows:

START .....	⌋ (out)
STOP .....	⌋ (in)
CLOCK .....	⌋ (out)
HOLD .....	off (out)
SELF TEST .....	off (out)

7. Turn the 3585A (and Signature Analyzer) on.

8. At this point, the CRT screen should be blank, the front-panel LED indicators should be flashing and the red LED on the A45 board should be flashing.

To verify that your test setup is correct and the test routine is running properly, touch the Signature Analysis test probe to A44 Pin A38.

The signature should be "C2HH".

9. Check the following signatures:

IC (Pin)	Signature	Edge Connector Pin
U39( 5)	0001	A26
U39(12)	1680	A30
U39(13)	9H2U	B30
U40( 9)	4268	B35
U40(11)	0000 (probe blinking)	B27

- a. If all the signatures are correct, go to step I-10.
- b. If any of the signatures are incorrect, the lines are being loaded. Remove the A44 board and check the signatures again at the Edge Connector pins. If the signature checks OK, see Table 11-F-3 for the Probable Defect. If the signatures are still incorrect go to the Central Processor Troubleshooting (A41 board, Service Group C).

**Table 11-F-3. Probable Defects For Interface Circuitry Inputs**

Incorrect Signature Location	Probable Defect
U39( 5)	U39,38,40,31
U39(12)	U39,40
U39(13)	U39,40
U40( 9)	U22,31,40
U40(11)	U40

10. Check the following signatures:

IC (Pin)	Signature
U38( 3)	IF17
U38( 6)	63UA
U38( 8)	OH89
U38(11)	C8U4
U31( 8)	4268
U40( 8)	UOC5

- a. If the signatures are correct the Interface Circuitry is operating correctly. Carefully inspect the PC board for shorts.
- b. If the signatures are incorrect, go to Figure 11-F-2 and trace down the problem using DSA. Start with the defective point and work backwards on the schematic.

**NOTE**

A "(B)" in back of a signature indicates that the probe is blinking. This is done only for 5V and ground signatures.

**HP-IB Calculator Test.**

The program shown in Table 11-F-5 will check the HP-IB operation of the instrument to a high level of confidence. This program is flow charted using controller independent language (meta message) so that it may be adapted to your controller (see Figure 4-23). If you have a -hp- 9825A calculator, a listing of this program appears in Table 11-F-5. The program is also contained on File 26, Track 0 of the Semi-Automatic Performance Test tape (P.N. 03585-10001). If an error is detected in the HP-IB interface of the 3585A, an error number will be printed out. The error definitions are contained in Table 11-F-4 and may be used to help locate problems on the 3585A HP-IB board.

To run the HP-IB check the -hp- 9825A calculator, insert the Semi-Automatic Performance Test tape in the calculator tape slot and press the following keys:



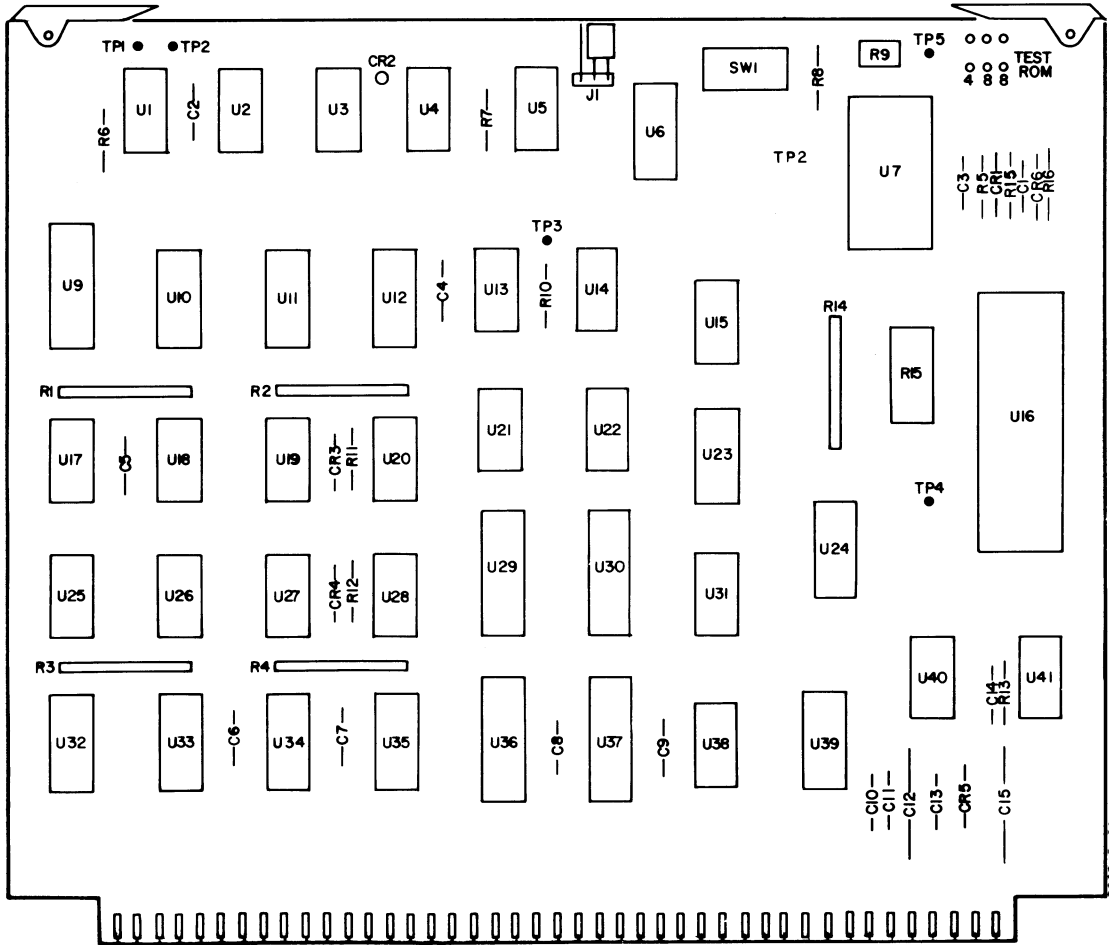
When the lazy "T" ( |— ) has reappeared on the 9825A display, press the **RUN** key. To complete the test, follow the instructions on the calculator display. If no HP-IB errors are found by the test, "HP-IB OK" will be printed by the calculator. This ends the HP-IB check program.

**Table 11-F-4. HP-IB Calculator Test Error Definitions**

Error #	Explanation
1	} Large HP-IB Problem; DSA Required
2	
3	
4	} Data Line Problem
5	
6	
7	} Front Panel Light or Interface Problem; otherwise use DSA
8	
9	
10	
11	

Table 11-F-5. HP-IB Check Program Listing For The 9825A Calculator

```
0: "HP-IB Test for Op. Verification 3/08/78":
1: spc 2;prt "HPIB Test";spc 2;0→Q
2: clr 711
3: rem 7
4: wrt 711,"D2T4"
5: red 711,A,B
6: if A#2e7;1→S;gsb "ERR"
7: wrt 711,"IRT4"
8: red 711,A,B
9: if A#2.004e7;2→S;gsb "ERR"
10: clr 711
11: wrt 711,"D2T4"
12: red 711,A,B
13: if A#2e7;3→S;gsb "ERR"
14: wrt 711,"ML"
15: wtb 731,255,255,112,1,0,2,85,170,170,85
16: wrt 711,"MD"
17: wtb 731,255,255,112,1,0,2
18: rdb(711)→A;rdb(711)→B;rdb(711)→C;rdb(711)→D
19: if A#85;4→S;gsb "ERR"
20: if B#170;5→S;gsb "ERR"
21: if C#170;6→S;gsb "ERR"
22: if D#85;7→S;gsb "ERR"
23: wtb 711,85,170
24: cli 7
25: lcl 7;8→S
26: 0→R;beep;ent "SRQ Light on=cont;off=1,cont",R;if R=1;gsb "ERR"
27: rds(711)→A
28: red 711;9→S
29: 0→R;beep;ent "Talk Light on=cont;off=1,cont",R;if R=1;gsb "ERR"
30: wrt 711
31: lcl 7;10→S
32: 0→R;beep;ent "Listen Light on=cont;off=1,cont",R;if R=1;gsb "ERR"
33: rem 7
34: wrt 711
35: cli 7;11→S
36: 0→R;beep;ent "Remote Light on=cont;off=1,cont",R;if R=1;gsb "ERR"
37: if Q=0;prt "HPIB OK";spc 2
38: end
39: "ERR":prt "HPIB Failure      Test #",S;spc 2;1→Q
40: ret
*6082
```



A44  
03585-66544

# **SERVICE GROUP G COUNTER**

**Board No. A46**

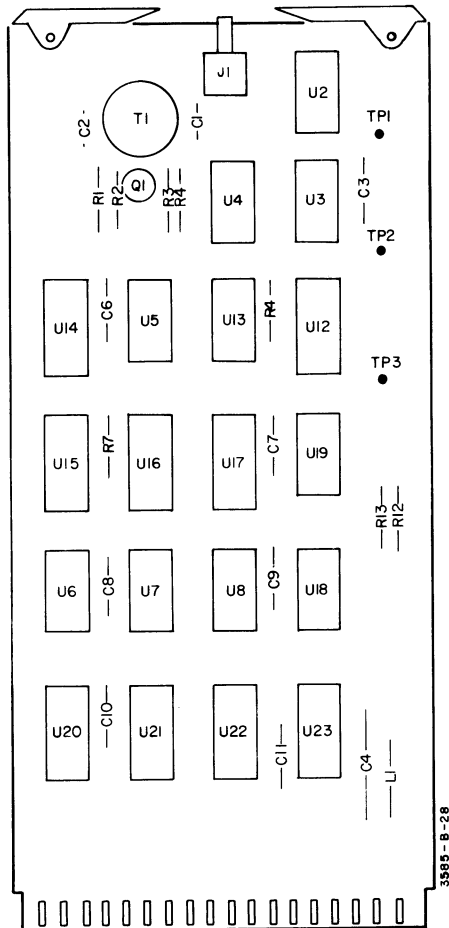
**Part Number 03585-66546**

## **INDEX:**

<b>Title</b>	<b>Page No.</b>
A46 Main Counter Troubleshooting Tree . . . . .	11-353/11-354
A46 Ripple Counter Troubleshooting Tree . . . . .	11-355/11-356

## **ADJUSTMENTS:**

None



**A46**  
**03585-66545**



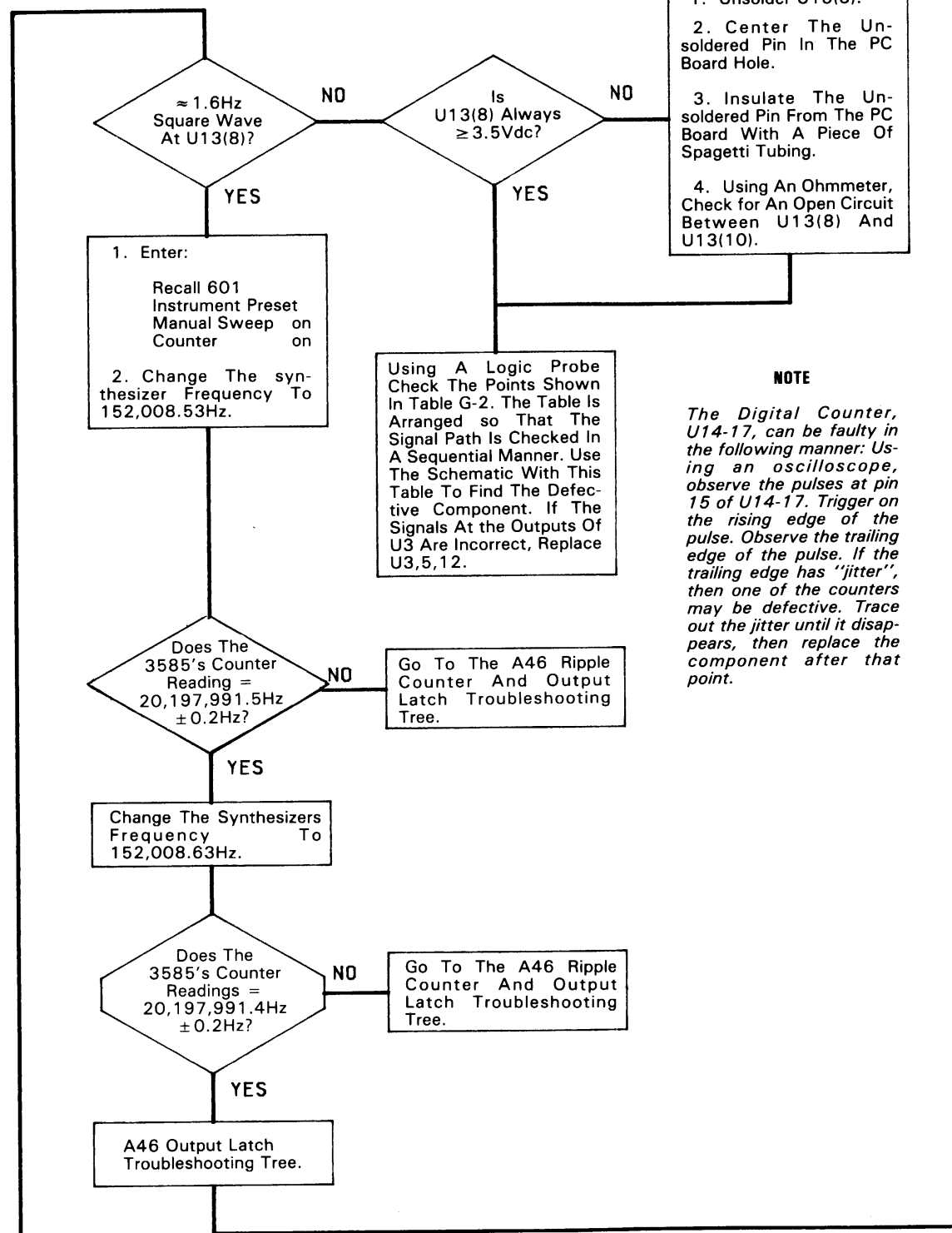
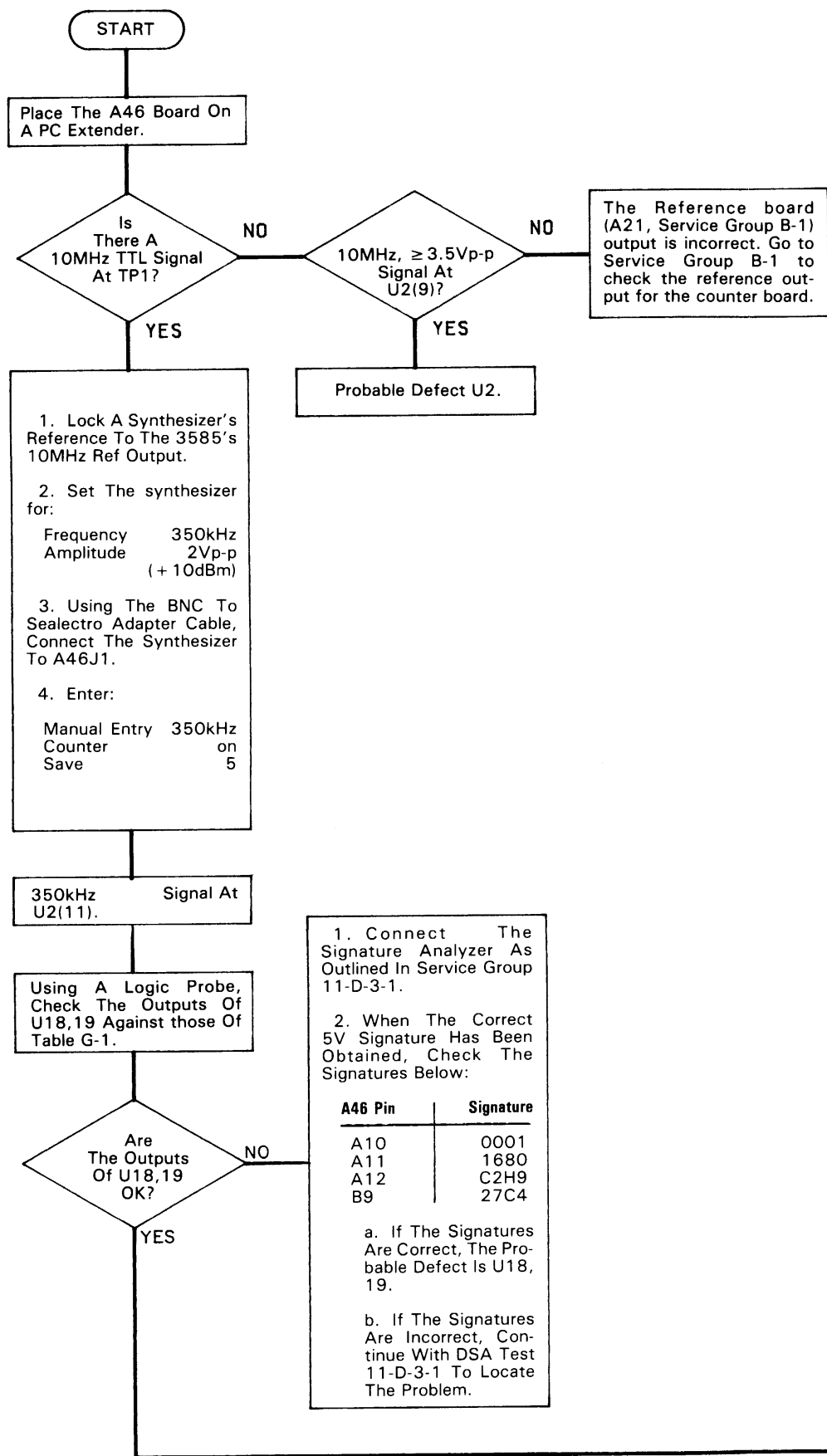


Table G-1. A46U18,19 Output Table.

IC Pin	Logic Probe Response
U19( 6)	$\approx 1.8$ sec of pulses followed by $\approx 0.3$ sec low
U19( 8)	Low
U19(12)	Low with occasional pulse high
U18( 8)	Pulsing
U18(12)	High with occasional low pulse

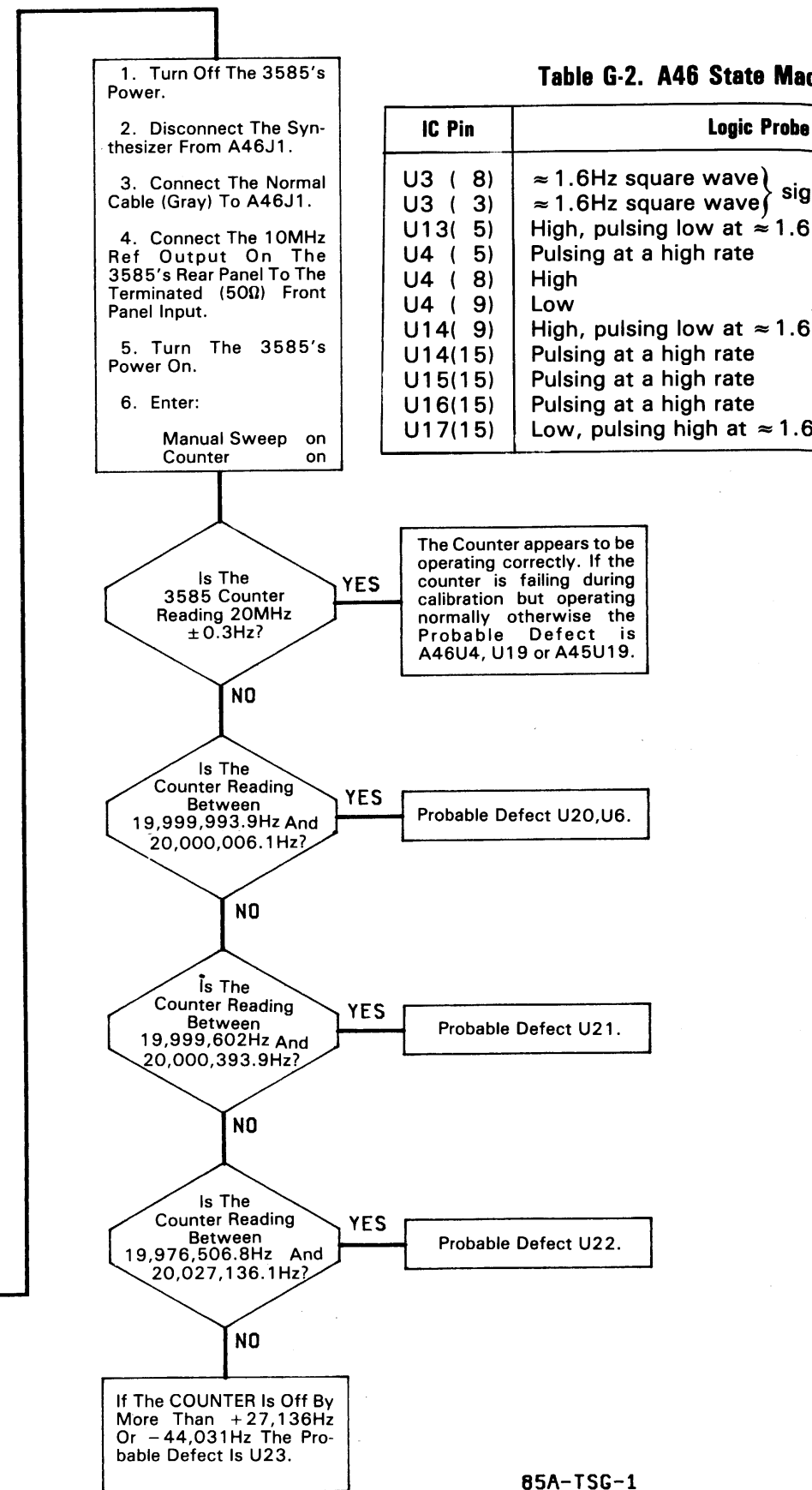
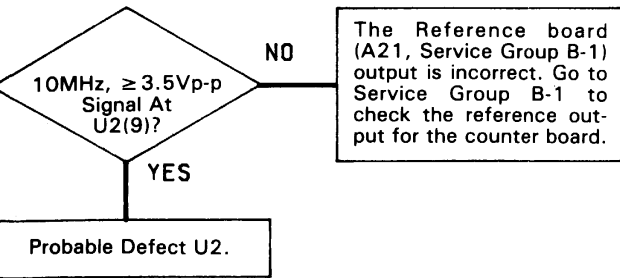


Table G-2. A46 State Machine

IC Pin	Logic Probe Response
U3 ( 8)	$\approx 1.6Hz$ square wave
U3 ( 3)	$\approx 1.6Hz$ square wave
U13( 5)	High, pulsing low at $\approx 1.6$
U4 ( 5)	Pulsing at a high rate
U4 ( 8)	High
U4 ( 9)	Low
U14( 9)	High, pulsing low at $\approx 1.6$
U14(15)	Pulsing at a high rate
U15(15)	Pulsing at a high rate
U16(15)	Pulsing at a high rate
U17(15)	Low, pulsing high at $\approx 1.6$



1. Connect The Signature Analyzer As Outlined In Service Group 11-D-3-1.

2. When The Correct 5V Signature Has Been Obtained, Check The Signatures Below:

A46 Pin	Signature
A10	0001
A11	1680
A12	C2H9
B9	27C4

a. If The Signatures Are Correct, The Probable Defect Is U18, 19.

b. If The Signatures Are Incorrect, Continue With DSA Test 11-D-3-1 To Locate The Problem.

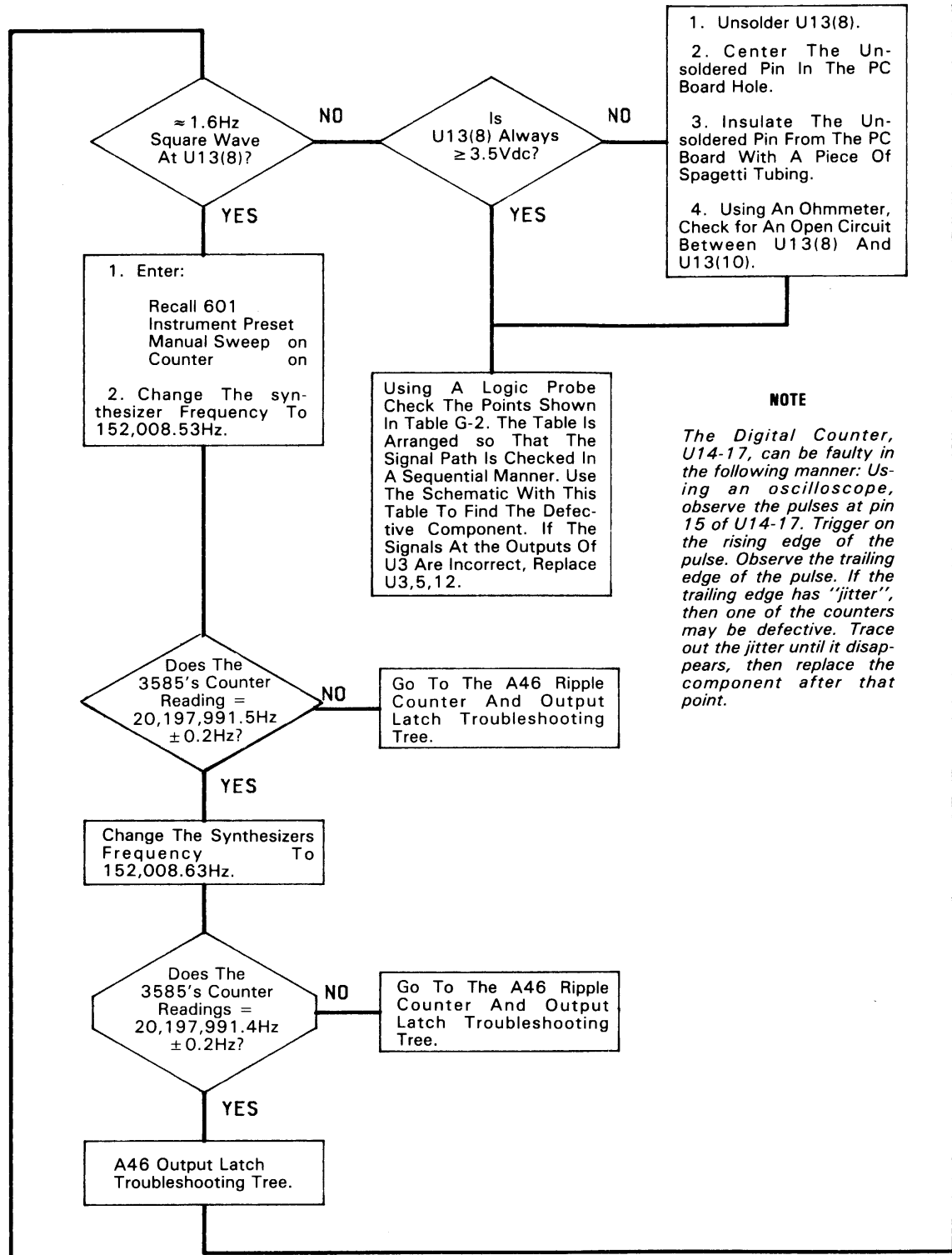


Table G-1. A46U18,19 Output Table.

IC Pin	Logic Probe Response
U19( 6)	≈ 1.8 sec of pulses followed by ≈ 0.3 sec low
U19( 8)	Low
U19(12)	Low with occasional pulse high
U18( 8)	Pulsing
U18(12)	High with occasional low pulse

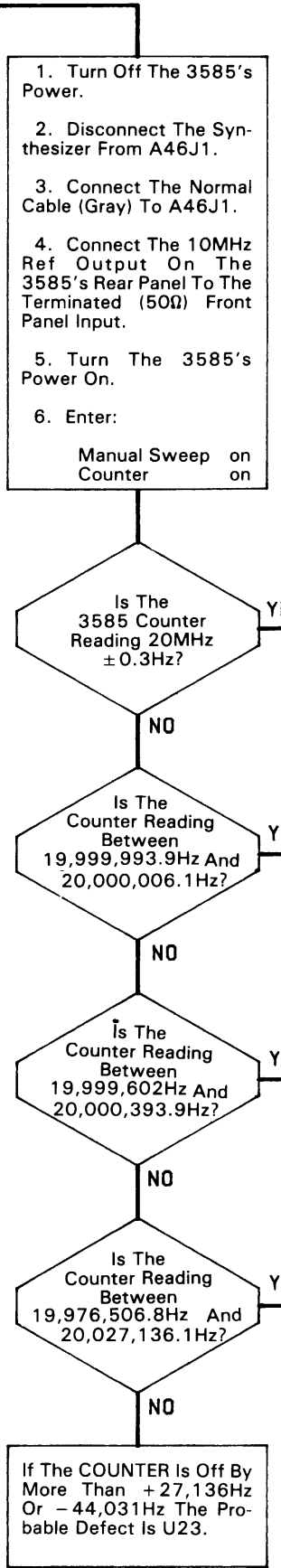
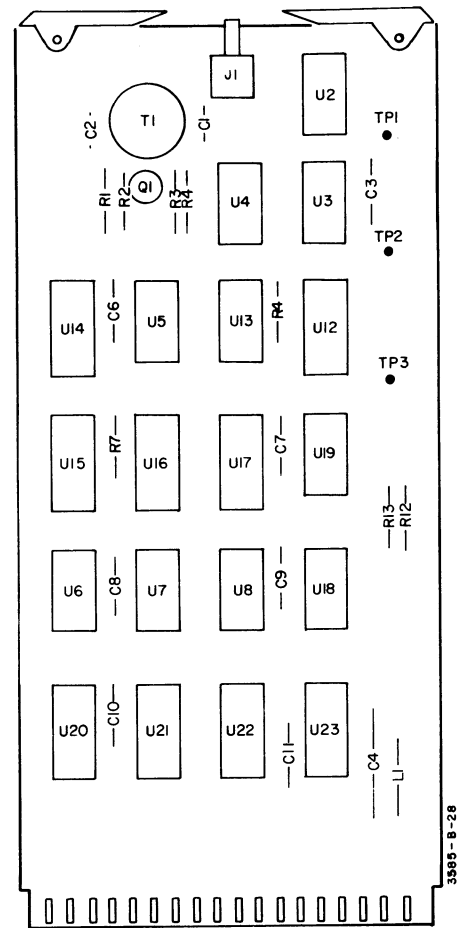


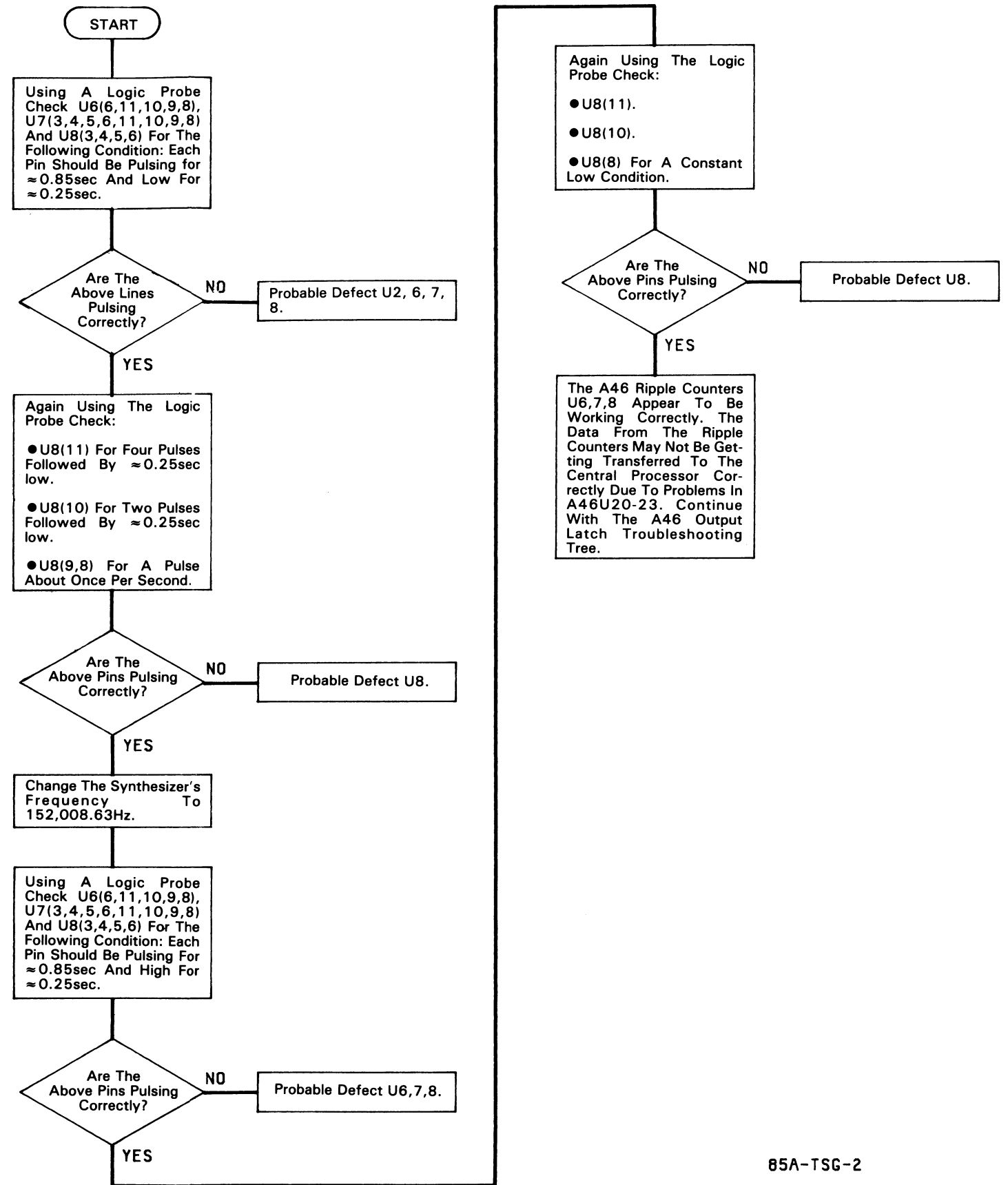
Table G-2. A46 State Machine Outputs.

IC Pin	Logic Probe Response
U3 ( 8)	≈ 1.6Hz square wave } signals have opposite phase
U3 ( 3)	
U13( 5)	High, pulsing low at ≈ 1.6Hz rate
U4 ( 5)	Pulsing at a high rate
U4 ( 8)	High
U4 ( 9)	Low
U14( 9)	High, pulsing low at ≈ 1.6Hz rate
U14(15)	Pulsing at a high rate
U15(15)	Pulsing at a high rate
U16(15)	Pulsing at a high rate
U17(15)	Low, pulsing high at ≈ 1.6Hz rate



A46  
03585-66545

3585-8-28



# SERVICE GROUP H PLOTTER

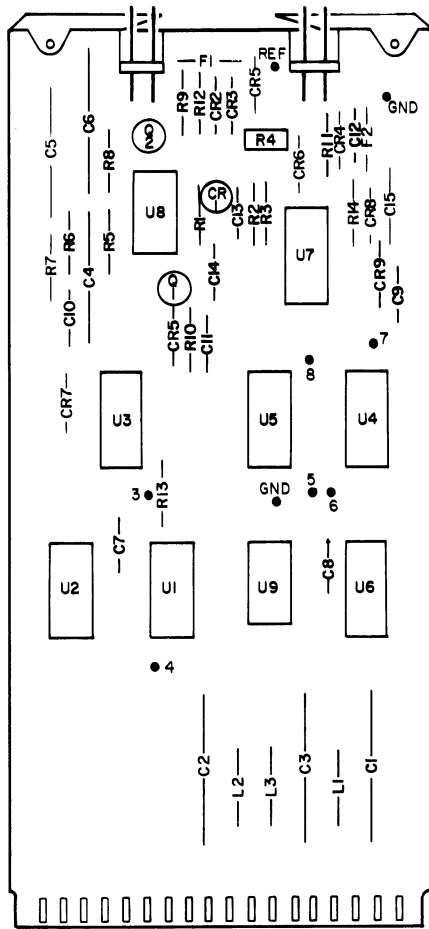
**Board Numbers A62,63**  
**Part Numbers 03585-66562, -66563**

**INDEX:**

Title	Page No.
A62 Plotter Troubleshooting Tree (X and Y Outputs) . . . . .	11-359/11-360
A63 Z Output Troubleshooting Tree . . . . .	11-361/11-362

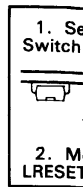
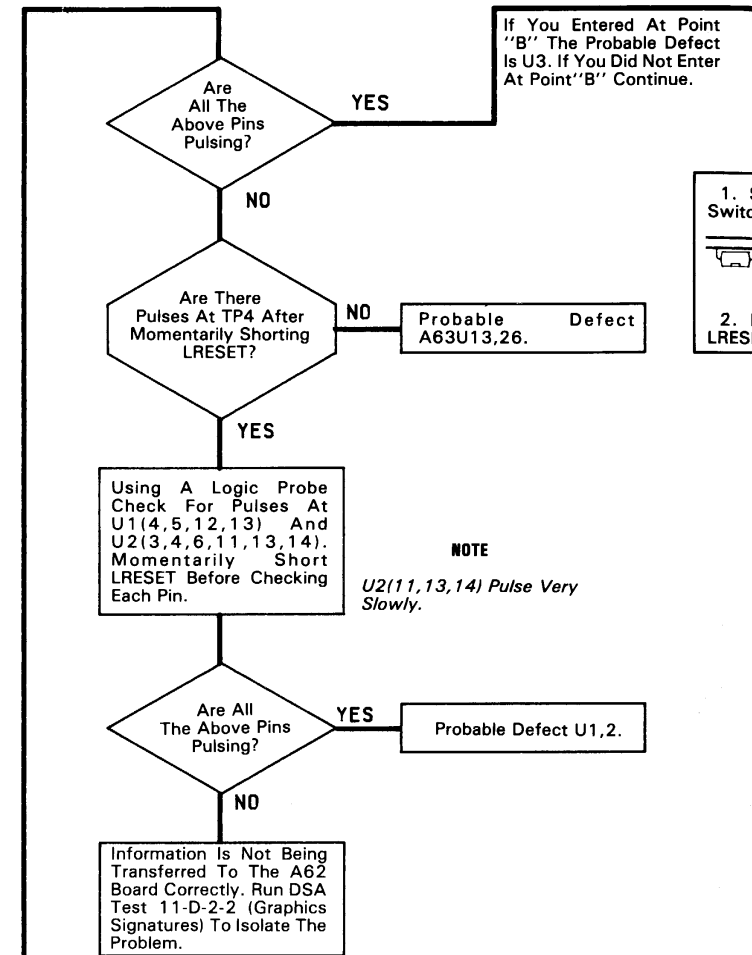
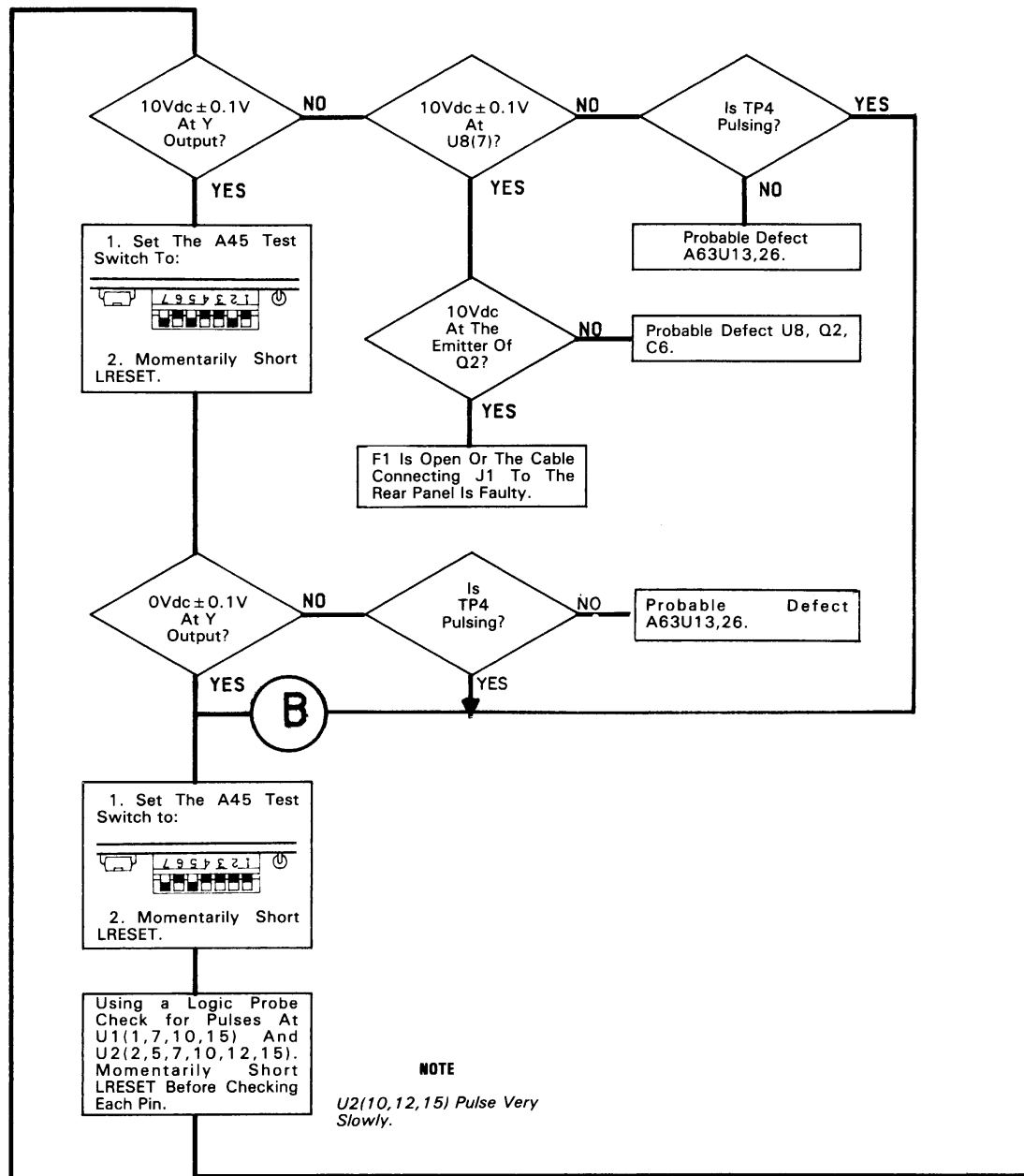
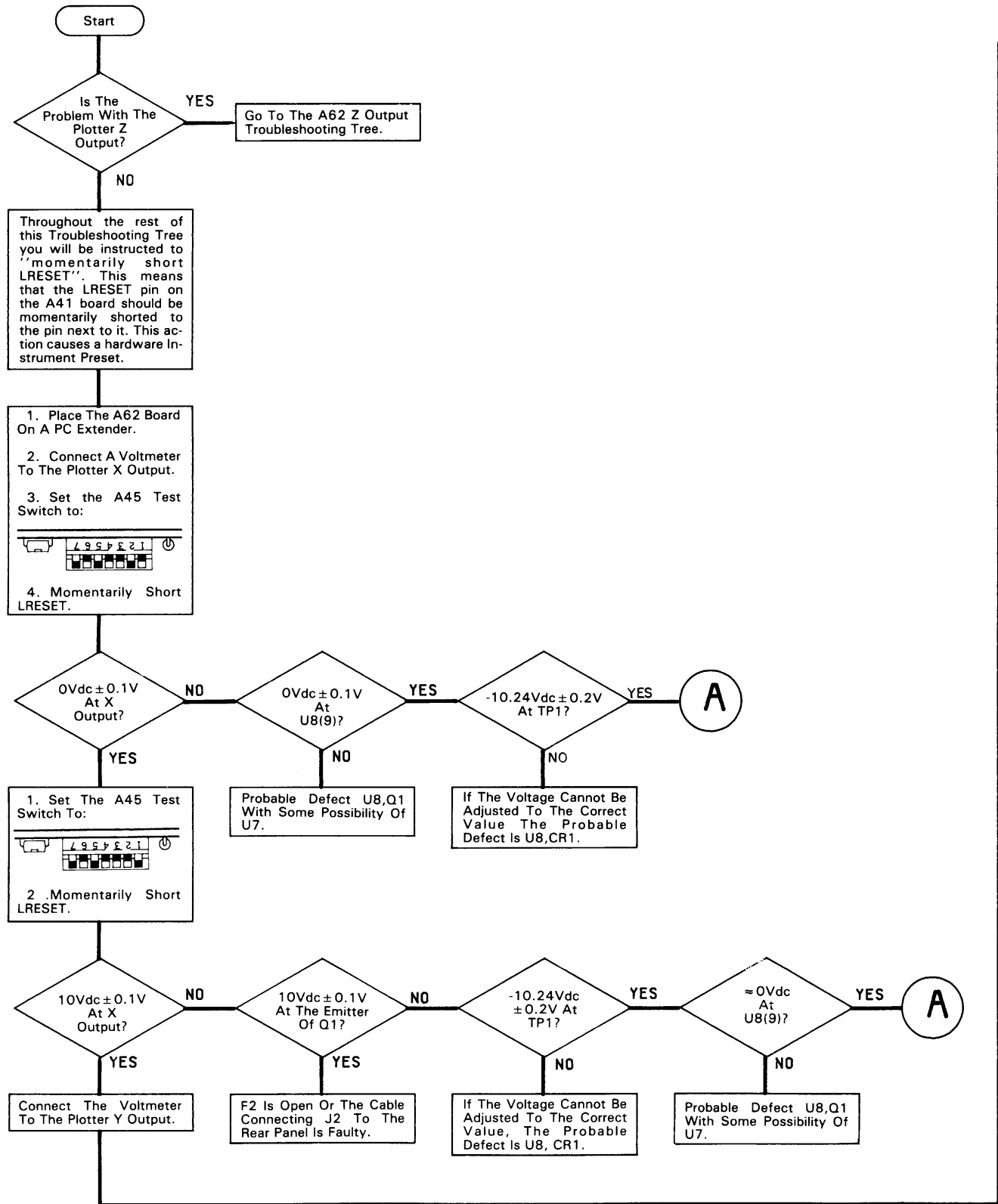
**ADJUSTMENTS:**

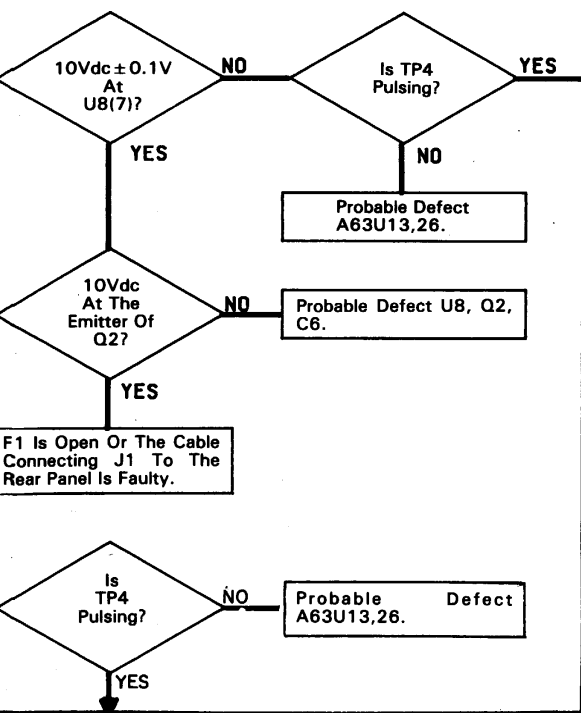
Component	Adjusted Parameter	Paragraph Location
A62R4	-10.24V Reference	5-48



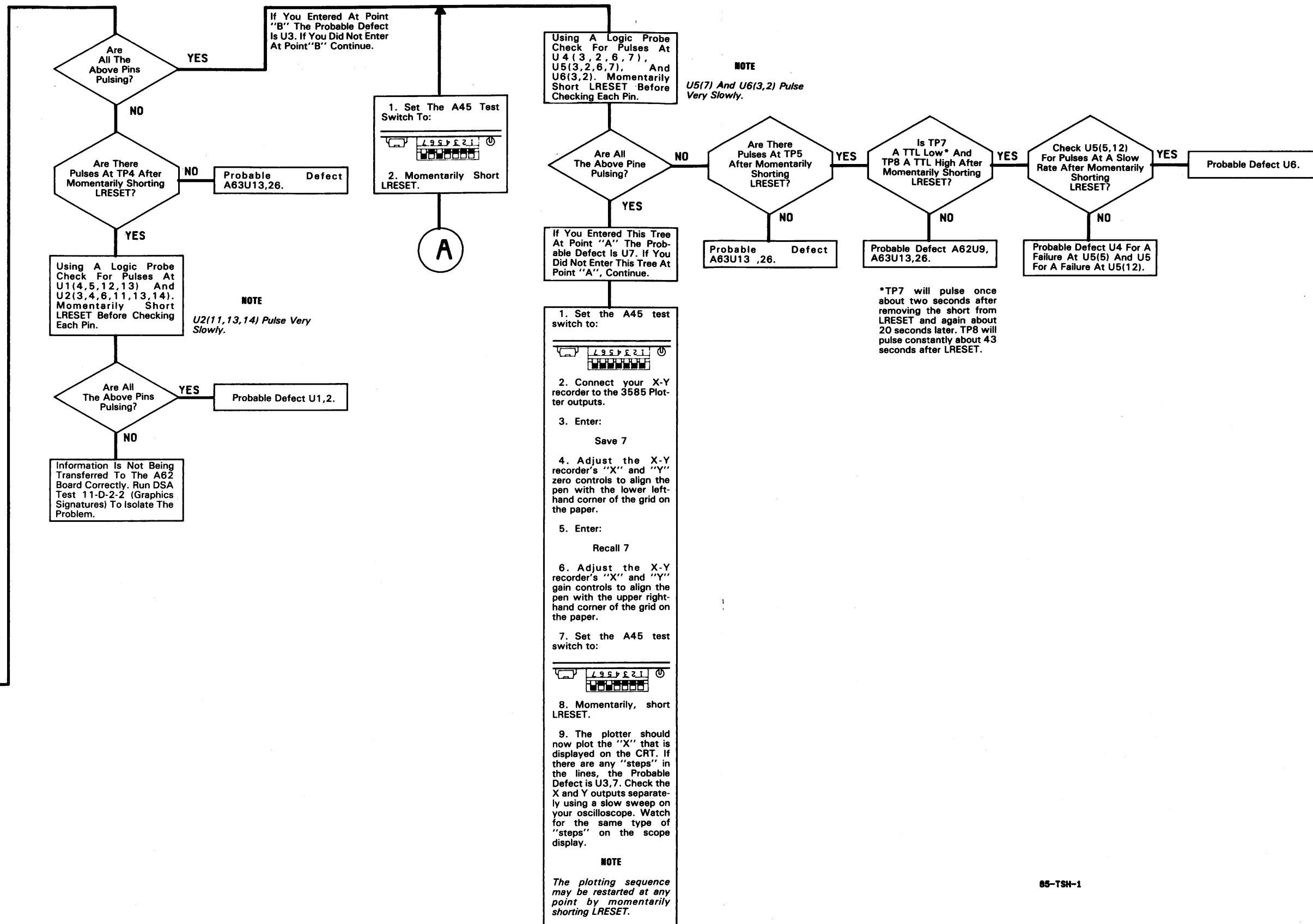
A62  
03585-66562

3585-8-2





NOTE  
10,12,15) Pulse Very Slowly.



Using A Logic Probe Check For Pulses At U4(3,2,6,7), U5(3,2,6,7), And U6(3,2). Momentarily Short LRESET Before Checking Each Pin.

NOTE  
U5(7) And U6(3,2) Pulse Very Slowly.

A

1. Set The A45 Test Switch To: 2. Momentarily Short LRESET.

Using A Logic Probe Check For Pulses At U1(4,5,12,13) And U2(3,4,6,11,13,14). Momentarily Short LRESET Before Checking Each Pin.

NOTE  
U2(11,13,14) Pulse Very Slowly.

1. Set the A45 test switch to:

2. Connect your X-Y recorder to the 3585 Plotter outputs.  
3. Enter:  
Save 7  
4. Adjust the X-Y recorder's "X" and "Y" zero controls to align the pen with the lower left-hand corner of the grid on the paper.  
5. Enter:  
Recall 7  
6. Adjust the X-Y recorder's "X" and "Y" gain controls to align the pen with the upper right-hand corner of the grid on the paper.

7. Set the A45 test switch to:

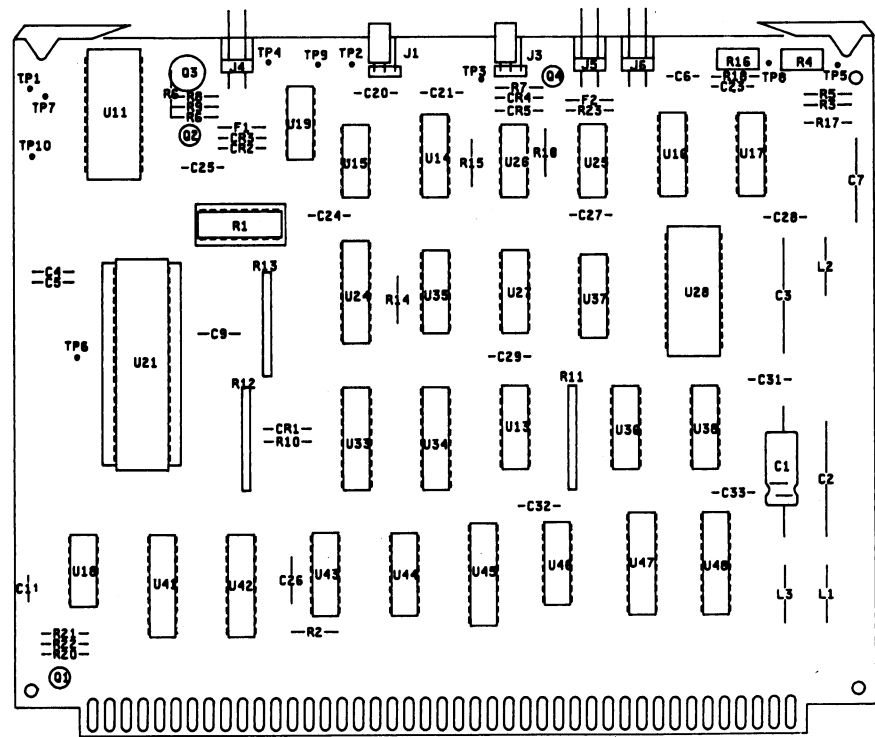
8. Momentarily, short LRESET.

9. The plotter should now plot the "X" that is displayed on the CRT. If there are any "steps" in the lines, the Probable Defect is U3,7. Check the X and Y outputs separately using a slow sweep on your oscilloscope. Watch for the same type of "steps" on the scope display.

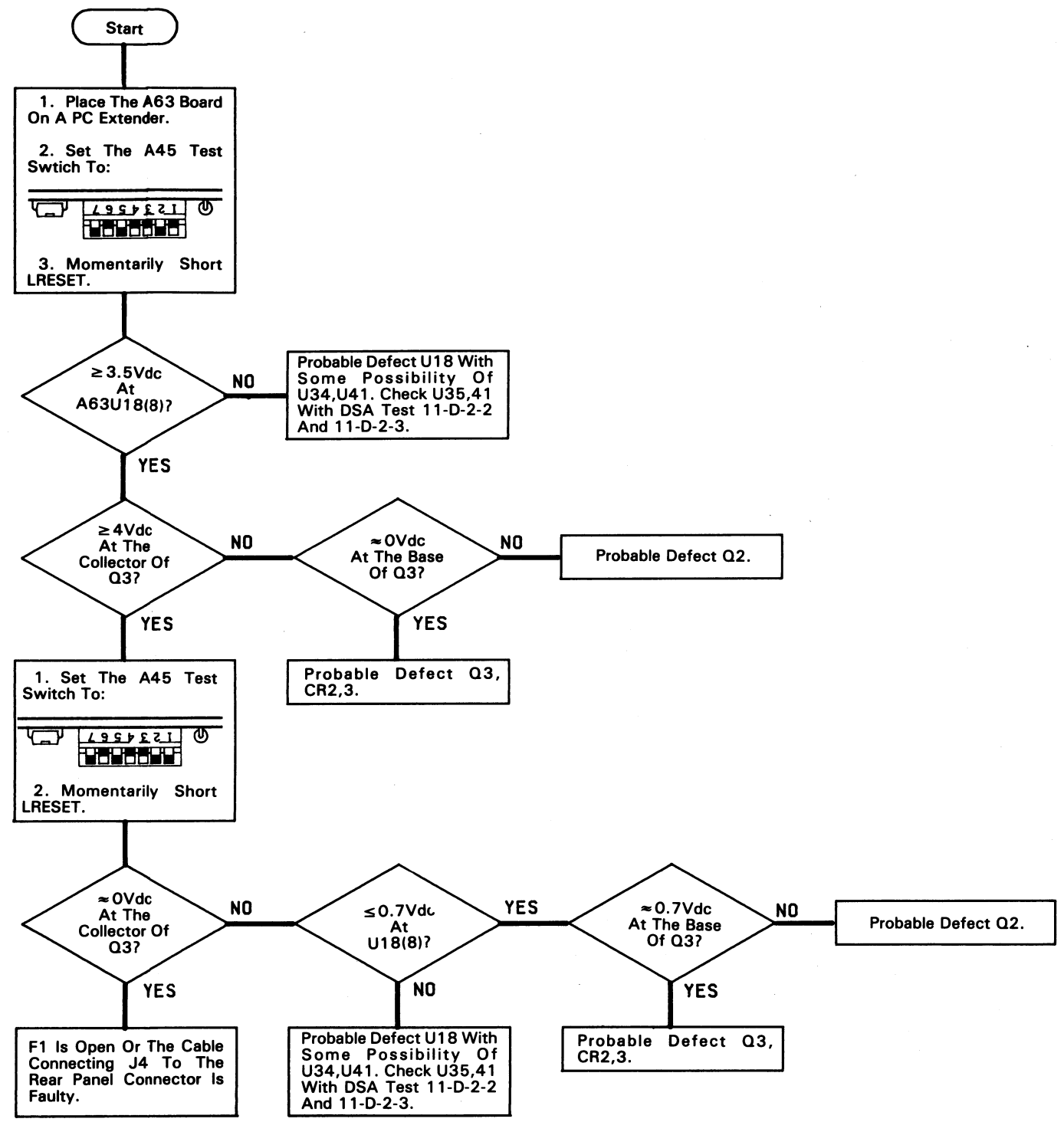
NOTE

The plotting sequence may be restarted at any point by momentarily shorting LRESET.

\*TP7 will pulse once about two seconds after removing the short from LRESET and again about 20 seconds later. TP8 will pulse constantly about 43 seconds after LRESET.



A63  
03585-86563





# SERVICE GROUP I POWER SUPPLIES

**Board Numbers A70-76**

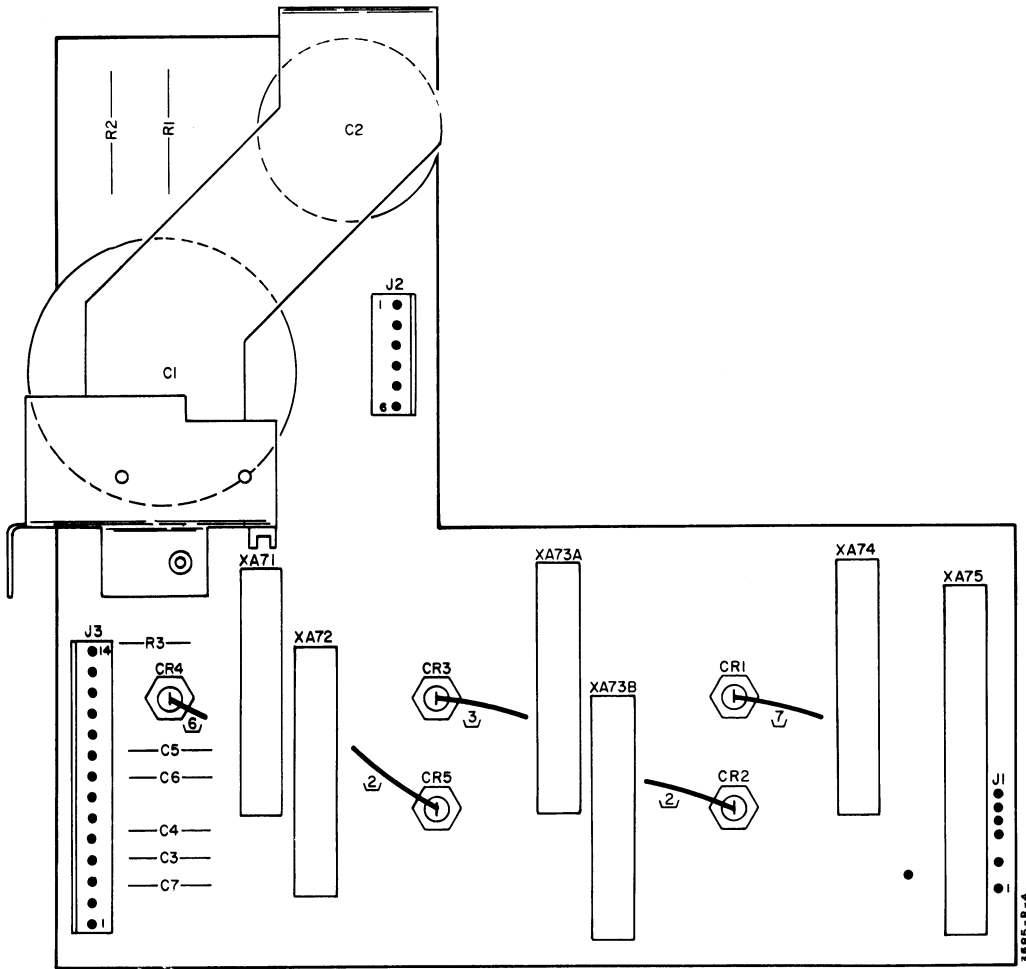
**Part Numbers 03585-66570 thru 03585-66576**

**INDEX:**

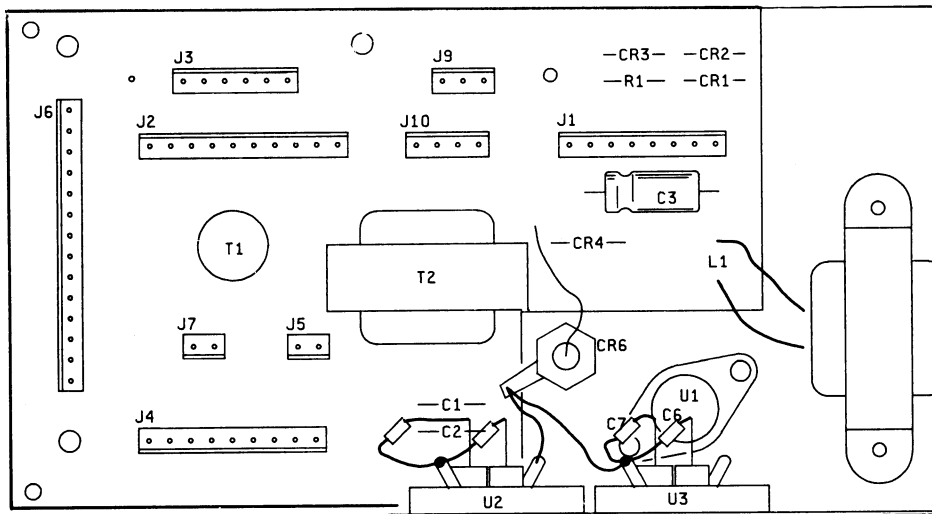
Title	Service Group No.	Page No.
Main Power Supply Troubleshooting Tree		11-365/11-366
A75 Power Supply Control And Power Transformer Troubleshooting Tree		11-367/11-368
7.7V Power Supply	11-I-2-1	11-369
5V Power Supply	11-I-2-2	11-373
12V Power Supply	11-I-2-3	11-377
18V Power Supply	11-I-2-4	11-381
-18V Power Supply	11-I-2-5	11-385

**ADJUSTMENTS:**

Component	Adjusted Parameter	Paragraph Location
A72R19	5V Power Supply Current Limit	5-6
A72R31	5V Power Supply Voltage Adjustment	5-6
A75R9	18V Reference	5-6
A75R15	10kHz Power Supply Clock Frequency	5-6



**A70**  
03585-66570



**A76**  
03585-66576

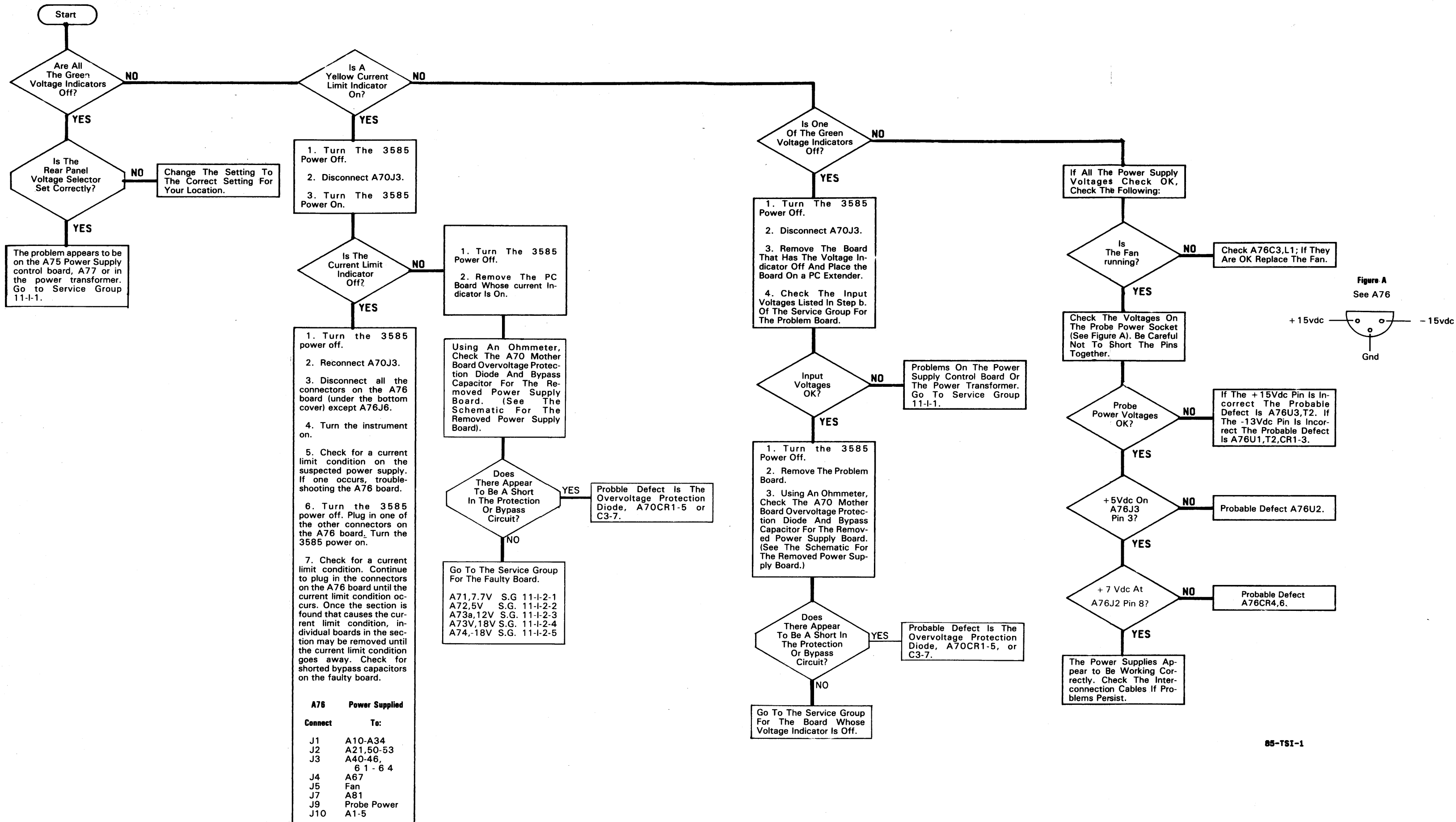
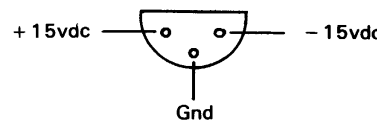
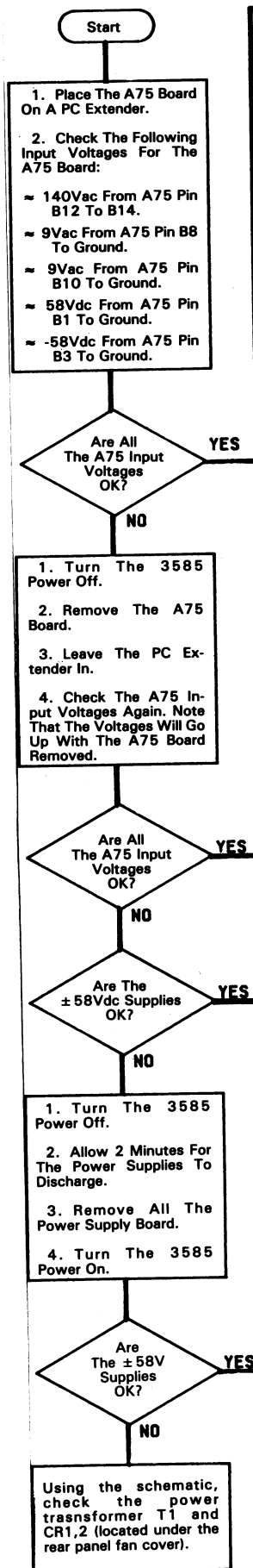
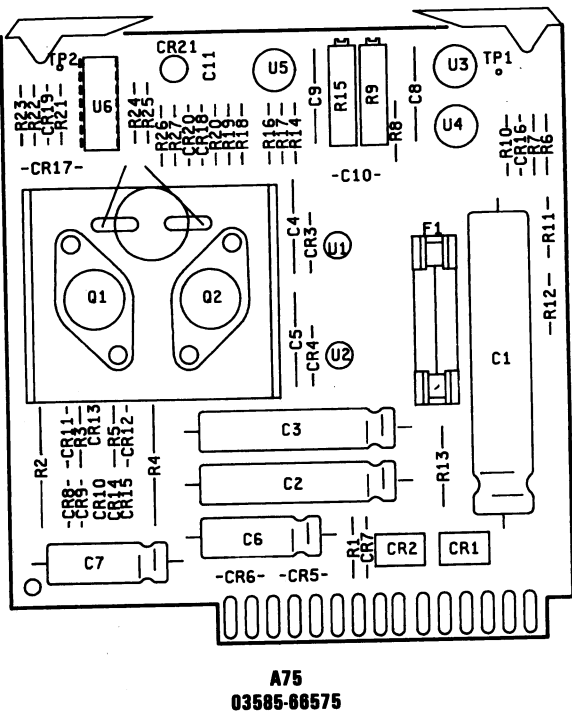


Figure A See A76



A76 Connect	Power Supplied To:
J1	A10-A34
J2	A21,50-53
J3	A40-46, 61-64
J4	A67
J5	Fan
J7	A81
J9	Probe Power
J10	A1-5

- Go To The Service Group For The Faulty Board.
- A71,7.7V S.G. 11-1-2-1
  - A72,5V S.G. 11-1-2-2
  - A73a,12V S.G. 11-1-2-3
  - A73V,18V S.G. 11-1-2-4
  - A74,-18V S.G. 11-1-2-5



**WARNING**

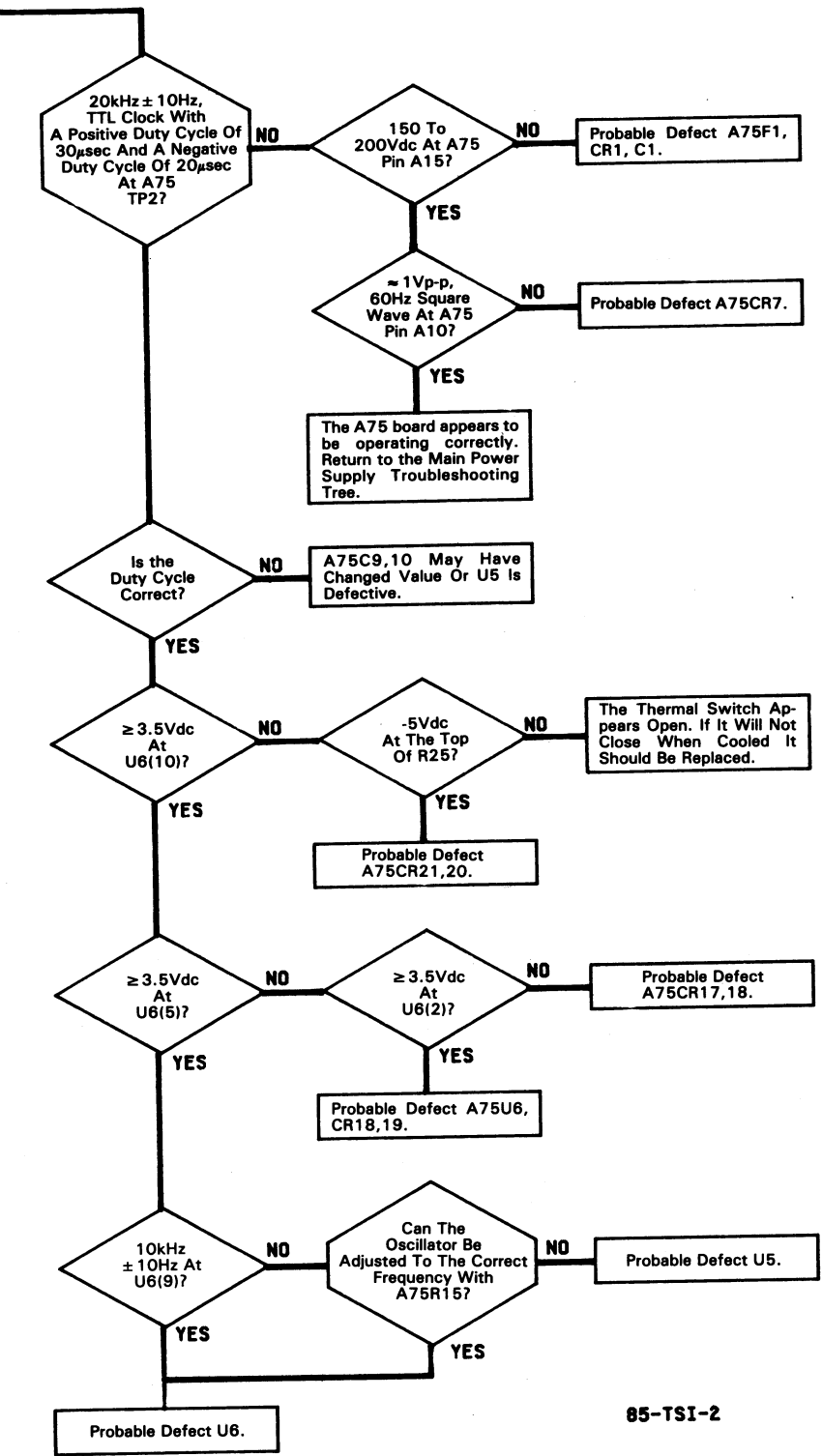
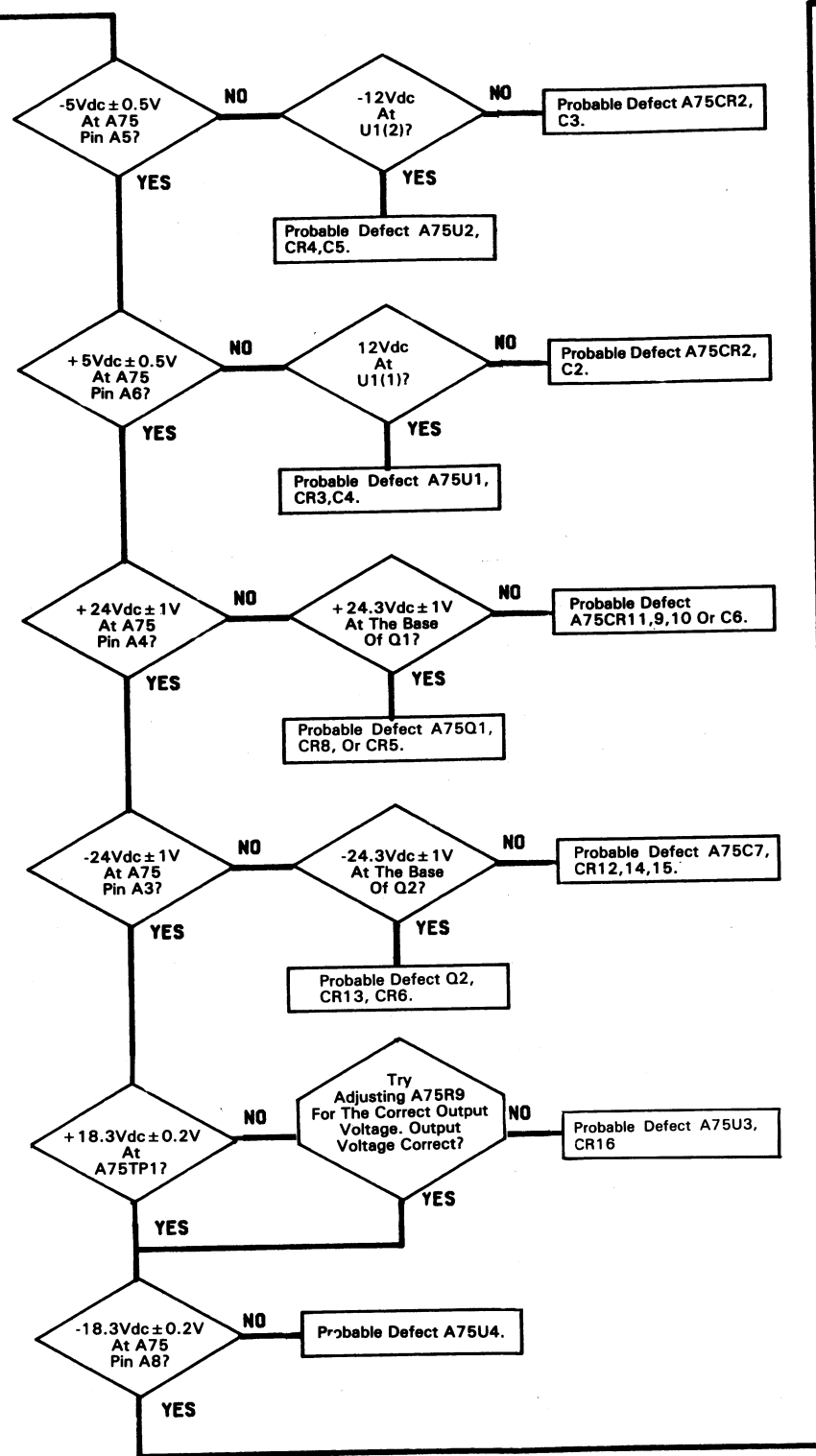
185Vdc is exposed on this board. Use caution when handling with power applied to avoid personal injury.

Using The Schematic Check For Shorted Components On The A75 board. Check A75CR1,2, 5,6,11,12; Q1,2; C1,2, 3,6,7.

**NOTE**

If all the voltages are incorrect or non-existent the Probable Defect is T1, the power switch, the voltage selector or the line filter.

- Turn The 3585 Power Off.
- Allow 2 Minutes For The Power Supplies To Discharge.
- Install The A75 Board And One Of The Power Supply Boards.
- Turn The 3585 Power On.
- Check The ±58Vdc Supplies. If The ±58Vdc Supplies Are Incorrect, Go To The Troubleshooting Information For The Particular.
- Repeat The Above Five Steps, Putting In Another Power Supply Board At Each Repetition.



## SERVICE GROUP 11-I-2-1 +7.7V POWER SUPPLY

**Board No. A71**

**Part Number 03585-66571**

- a. Turn the 3585's power off.  
Place the A71 board on a PC extender.  
Disconnect A70J3.
- b. If you have not already checked the inputs to this board check them against the following list. An absence of any of these signals indicates problems on the A75 board (Service Group I-1).

XA71 Pin	dc Voltage
A1	+ 24V
A2	+ 5V
A3	20kHz TTL Clock
A5	+ 18V
A10	+ 50V*
B1	- 24V
B2	- 5V

\*  $\approx$  64V when A70J3 is disconnected.

- c. Check the continuity of the fuse, F1.
- d. In order to check the operation of the switching supply the switching hybrid, U1 must be removed. This device is socketed and may be removed by unscrewing the two screws holding it down, then gently pulling on the device.
- e. Connect 1/4 Watt, 100 $\Omega$  resistor (-hp- Part Number 0683-1015) from the cathode of CR2 to the positive side of C1.
- f. Turn the 3585 power on.
- g. Using an ac coupled oscilloscope check for a 2.5Vp-p square wave at the cathode of CR2.
  1. If the 2.5Vp-p square wave is present, continue with step h.
  2. If the 2.5Vp-p signal is not present, the Probable Defect is U4, Q1, Q2 or CR2. \*\* Use the schematic to track the signal loss down.
- h. Connect variable supply to A71TP1.

\*\*If the stated devices check good, the problem is in the current limit circuitry. Continue with the troubleshooting procedure at step k to locate the problem.

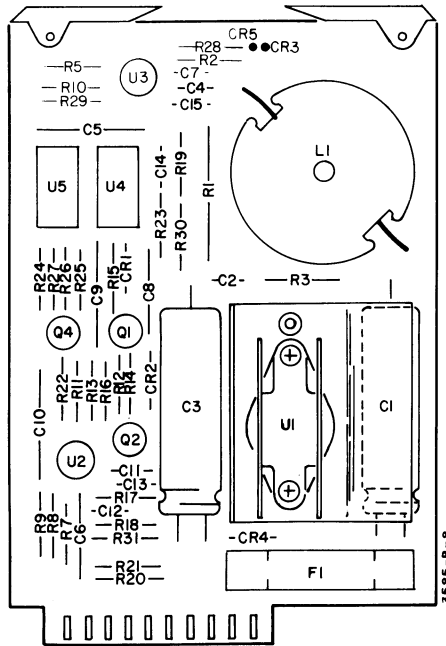
- i. Turn on the variable power supply and adjust it for 7.5V. The green LED should now be on.
  1. If the LED is on, continue at step j.
  2. If the LED is off or the power supply cannot be adjusted to 7.5V, the Probable Defect is the output capacitor C3, the reverse voltage protection diode CR4 or the overvoltage clamping diode A70CR4. Other possibilities are A71C2, A70C5, and A71CR3.
- j. Increase the voltage of the variable power supply by approximately one volt. Note the effect increase on the oscilloscope waveform as the voltage is increased (cathode of CR2).
  1. If the negative portion of the oscilloscope waveform gets narrower, continue with step l.
  2. If there is no change in the oscilloscope waveform, go to step k.
- k. Check for  $\approx 2V_{p-p}$  riding on 24Vdc at U2(6).
  1. If the signal is present, the Probable Defect is U2.
  2. If no square wave is present the Probable Defect is Q4,U3,4,15. check for a TTL low at U5(6) and a TTL high at U5(1).
- l. Turn off the variable power supply. Adjust the voltage control for zero volts.
- m. Connect the variable power supply's negative lead to TP1 and the positive lead through a 10k $\Omega$ , 1/4 Watt resistor (-hp- Part Number 0683-1035) to U3(3).
- n. Turn on the variable power supply. Slowly vary the voltage until the oscilloscope waveform goes to a positive level (dc level, no square wave), the yellow LED should now be on.
  1. If the LED lights and the square wave changes to dc, go to step o.
  2. If either condition does not occur, the Probable Defect is U3,4,5,CR5.
- o. Turn off the variable power supply and the 3585.
- p. Remove the A71 board from the PC extender. Discharge C1 by shorting across it.



*Failure to discharge the aforementioned capacitor will destroy the new part you are about to put in.*

- q. Install a new U1 switching hybrid if everything has checked good to this point. Replace the board in the card nest.

- r. Turn on the 3585 power. The five green LED's on the power supplies should now be lit.
- s. Reconnect A70J3 and replace the PC hold-down bar and plastic cover for the power supplies.



A71  
03585-66571

## SERVICE GROUP 11-I-2-2 +5V POWER SUPPLY

**Board No. A72**

**Part Number 03585-66572**

- a. Turn the 3585's power off.  
Place the A72 board on a PC extender.  
Disconnect A70J3.
- b. If you have not already checked the inputs to this board check them against the following list. An absence of any of these signals indicates problems on the A75 board (Service Group I-1).

XA72 Pin	Voltage
A1	+ 24V
A2	+ 5V
A3	20kHz TTL Clock
B1	- 24V
B20	- 5V*
B4	+ 18V ref
B10	+ 50V*

\*  $\approx$  64V when A70J3 is disconnected.

- c. Check the continuity of the fuse, F1.
- d. In order to check the operation of the switching supply the switching hybrid, U5 must be removed. This device is socketed and may be removed by unscrewing the two screws holding it down, then gently pulling on the device.
- e. Connect 1/4 Watt, 100 $\Omega$  resistor (-hp- Part Number 0683-1015) from the cathode of CR1 to the positive side of C1.
- f. Turn the 3585 power on.
- g. Using an ac coupled oscilloscope check for a 2.5Vp-p square wave at the cathode of CR1.
  1. If the 2.5Vp-p square wave is present, continue with step h.
  2. If the 2.5Vp-p signal is not present, the Probable Defect is Q3, Q5, U3, or CR1.\*\* Use the schematic to track the signal loss down.
- h. Connect variable supply to A72TP1.

\*\*If the stated devices check good, the problem is in the current limit circuitry. Continue with the troubleshooting procedure at step k to locate the problem.



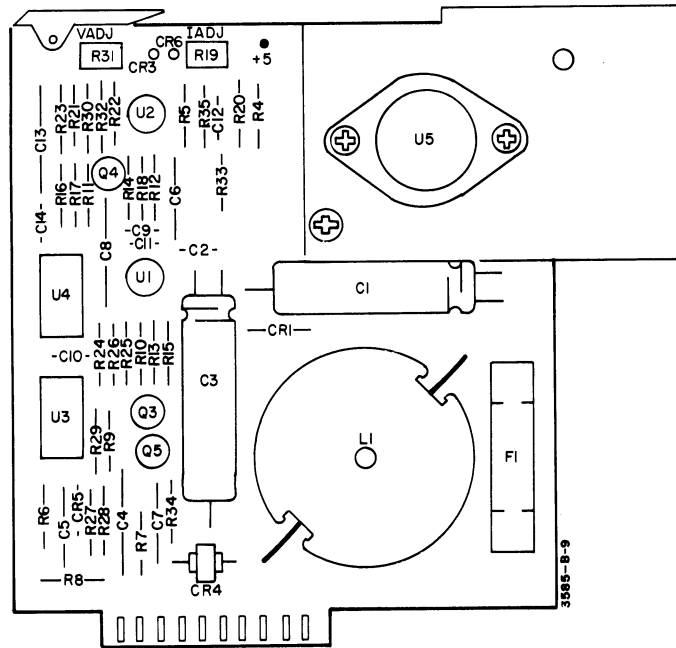
- i. Turn on the variable power supply and adjust it for 5.0V. The green LED should now be on.
  1. If the LED is on, continue at step j.
  2. If the LED is off or the power supply cannot be adjusted to 5V, the Probable Defect is the output capacitor C3, the reverse voltage protection diode CR4 or the overvoltage clamping diode A70CR5. Other possibilities are A72C2, A70C6 and A72CR3.
- j. Increase the voltage of the variable power supply by approximately one volt. Note the effect on the oscilloscope waveform as the voltage is increased (cathode of CR1).
  1. If the negative portion of the oscilloscope waveform gets narrower, continue with step l.
  2. If there is no change in the oscilloscope waveform, go to step k.
- k. Check for  $\approx 2V_{p-p}$  riding on 24Vdc at U2(6).
  1. If the signal is present, the Probable Defect is U1.
  2. If no square wave is present the Probable Defect is Q4,U3,4,15. check for a TTL low at U4(6) and a TTL high at U4(1).
- l. Turn off the variable power supply. Adjust the voltage control for zero volts.
- m. Connect the variable power supply's negative lead to TP1 and the positive lead to a 10k $\Omega$ , 1/4 Watt resistor (-hp- Part Number 0683-1035) to U2(3).
- n. Turn on the variable power supply. Slowly vary the voltage (do not exceed +5V) until the oscilloscope waveform goes to a positive level (dc level, no square wave), the yellow LED should now be on.
  1. If the LED lights and the square wave changes to dc, go to step o.
  2. If either condition does not occur, the Probable Defect is U2,3,4,CR6.
- o. Turn off the variable power supply and the 3585.
- p. Remove the A72 board from the PC extender. Discharge C1 by shorting across it.



*Failure to discharge the aforementioned capacitor will destroy the new part you are about to put in.*

- q. Install a new U5 switching hybrid if everything has checked good to this point. Replace the board in the card nest.

- r. Turn on the 3585 power. The five green LED's on the power supplies should now be lit.
- s. Reconnect A76J6 and replace the PC hold-down bar and plastic cover for the power supplies.



A72  
03585-66572

## SERVICE GROUP 11-I-2-3 +12V POWER SUPPLY

**Board No. A73a  
Part Number 03585-66573**

- a. Turn the 3585's power off.  
Place the A73a board on a PC extender.  
Disconnect A70J3.
- b. If you have not already checked the inputs to this board check them against the following list. An absence of any of these signals indicates problems on the A75 board (Service Group I-1).

XA73a Pin	Voltage
A1	+ 24V
A2	+ 5V
A3	20kHz TTL Clock
A10	+ 50V*
B1	- 24V*
B2	- 5V
B5	+ 18V ref

\*  $\approx$  64V when A70J3 is disconnected.

- c. Check the continuity of the fuse, F1.
- d. In order to check the operation of the switching supply the switching hybrid, U1 must be removed. This device is socketed and may be removed by unscrewing the two screws holding it down, then gently pulling on the device.
- e. Connect 1/4 Watt, 100 $\Omega$  resistor (-hp- Part Number 0683-1015) from the cathode of CR2 to the positive side of C1.
- f. Turn the 3585 power on.
- g. Using an ac coupled oscilloscope check for a 2.5Vp-p square wave at the cathode of CR2.
  1. If the 2.5Vp-p square wave is present, continue with step h.
  2. If the 2.5Vp-p signal is not present, the Probable Defect is U4, Q1, Q2 or CR2.\*\* Use the schematic to track the signal loss down.
- h. Connect variable supply to A73TP1.

\*\*If the stated devices check good, the problem is in the current limit circuitry. Continue with the troubleshooting procedure at step k to locate the problem.

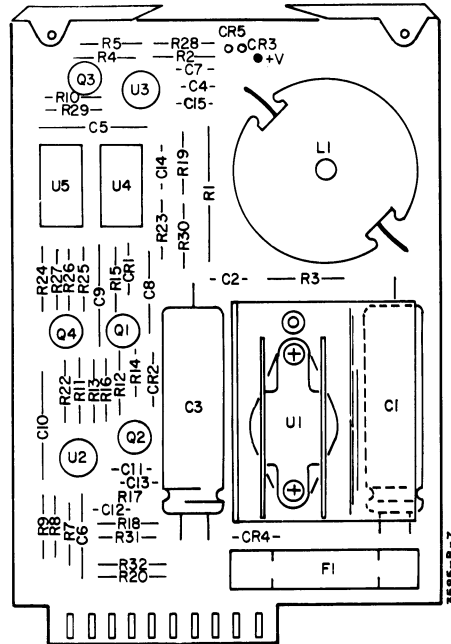
- i. Turn on the variable power supply and adjust it for 7.5V. The green LED should now be on.
  1. If the LED is on, continue at step j.
  2. If the LED is off or the power supply cannot be adjusted to 12V, the Probable Defect is the output capacitor C3, the reverse voltage protection diode CR4 or the overvoltage clamping diode A70CR3. Other possibilities are A73C2, A70C4, and A73CR3.
- j. Increase the voltage of the variable power supply by approximately one volt. Note the effect on the oscilloscope waveform as the voltage is increased (cathode of CR2).
  1. If the negative portion of the oscilloscope waveform gets narrower, continue with step l.
  2. If there is no change in the oscilloscope waveform, go to step k.
- k. Check for  $\approx 2V_{p-p}$  riding on 24Vdc at U2(6).
  1. If the signal is present, the Probable Defect is U2.
  2. If no square wave is present the Probable Defect is Q4,U3,4,5. check for a TTL low at U5(6) and a TTL high at U5(1).
- l. Turn off the variable power supply. Adjust the voltage control for zero volts.
- m. Connect the variable power supply's negative lead to TP1 and the positive lead to a 10k $\Omega$ , 1/4 Watt resistor (-hp- Part Number 0683-1035) to U3(3).
- n. Turn on the variable power supply. Slowly vary the voltage (do not exceed +5V) until the oscilloscope waveform goes to a positive level (dc level, no square wave), the yellow LED should now be on.
  1. If the LED lights and the square wave changes to dc, go to step o.
  2. If either condition does not occur, the Probable Defect is U3,4,5,CR5.
- o. Turn off the variable power supply and the 3585.
- p. Remove the A73a board from the PC extender. Discharge C1 by shorting across it.



*Failure to discharge the aforementioned capacitor will destroy the new part you are about to put in.*

- q. Install a new U1 switching hybrid if everything has checked good to this point. Replace the board in the card nest.

- r. Turn on the 3585 power. The five green LED's on the power supplies should now be lit.
- s. Reconnect A76J6 and replace the PC hold-down bar and plastic cover for the power supplies.



**A73**  
**03585-66573**

## SERVICE GROUP 11-I-2-4 +18V POWER SUPPLY

**Board No. A73b**  
**Part Number 03585-66573**

- a. Turn the 3585's power off.  
Place the A73 board on a PC extender.
- b. If you have not already checked the inputs to this board check them against the following list. An absence of any of these signals indicates problems on the A75 board (Service Group I-1).

XA73b Pin	Voltage
A1	+ 24V
A2	+ 5V
A3	20kHz TTL Clock
A10	+ 50V*
B1	- 24V
B2	- 5V
B5	+ 18V ref

\*  $\approx$  64V when A70J3 is disconnected.

- c. Check the continuity of the fuse, F1.
- d. In order to check the operation of the switching supply the switching hybrid, U1 must be removed. This device must be unsoldered and removed by unscrewing the two screws holding it down, then gently pulling on the device.
- e. Connect 1/4 Watt, 100 $\Omega$  resistor (-hp- Part Number 0683-1015) from the cathode of CR2 to the positive side of C1.
- f. Turn the 3585 power on.
- g. Using an ac coupled oscilloscope check for a 2.5Vp-p square wave at the cathode of CR2.
  1. If the 2.5Vp-p square wave is present, continue with step h.
  2. If the 2.5Vp-p signal is not present, the Probable Defect is U4, Q1, Q2 or CR2.\*\* Use the schematic to track the signal loss down.
- h. Connect variable supply to A73TP1.

\*\*If the stated devices check good, the problem is in the current limit circuitry. Continue with the troubleshooting procedure at step k to locate the problem.

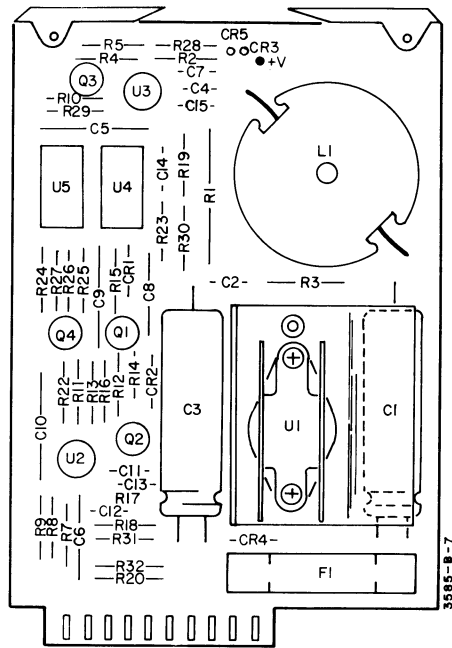
- i. Turn on the variable power supply and adjust it for +18.0V. The green LED should now be on.
  1. If the LED is on, continue at step j.
  2. If the LED is off or the power supply cannot be adjusted to +18V, the Probable Defect is the output capacitor C3, the reverse voltage protection diode CR4 or the overvoltage clamping diode A70CR2. Other possibilities are A73bC2, A70C3, and A73CR3.
- j. Increase the voltage of the variable power supply by approximately one volt. Note the effect on the oscilloscope waveform as the voltage is increased (cathode of CR2).
  1. If the negative portion of the oscilloscope waveform gets narrower, continue with step l.
  2. If there is no change in the oscilloscope waveform, go to step k.
- k. Check for  $\approx 2V_{p-p}$  riding on 24Vdc at U2(6).
  1. If the signal is present, the Probable Defect is U2.
  2. If no square wave is present the Probable Defect is Q4,U3,4,5. check for a TTL low at U5(6) and a TTL high at U5(1).
- l. Turn off the variable power supply. Adjust the voltage control for zero volts.
- m. Connect the variable power supply's negative lead to TP1 and the positive lead to a 10k $\Omega$ , 1/4 Watt resistor (-hp- Part Number 0683-1035) to U3(3).
- n. Turn on the variable power supply. Slowly vary the voltage (do not exceed +5V) until the oscilloscope waveform goes to a positive level (dc level, no square wave), the yellow LED should now be on.
  1. If the LED lights and the square wave changes to dc, go to step o.
  2. If either condition does not occur, the Probable Defect is U3,4,5,CR5.
- o. Turn off the variable power supply and the 3585.
- p. Remove the A73b board from the PC extender. Discharge C1 by shorting across it.



*Failure to discharge the aforementioned capacitor will destroy the new part you are about to put in.*

- q. Install a new U1 switching hybrid if everything has checked good to this point. Replace the board in the card nest.

- r. Turn on the 3585 power. The five green LED's on the power supplies should now be lit.
- s. Reconnect A76J6 and replace the PC hold-down bar and plastic cover for the power supplies.



**A73**  
**03585-66573**



## SERVICE GROUP 11-I-2-5 - 18V POWER SUPPLY

**Board No. A74**  
**Part Number 03585-66574**

- a. Turn the 3585's power off.  
Place the A74 board on a PC extender.
- b. If you have not already checked the inputs to this board check them against the following list. An absence of any of these signals indicates problems on the A75 board (Service Group I-1).

XA74 Pin	Voltage
A1	+ 24V
A2	+ 5V
A3	20kHz TTL Clock
A5	- 18V ref
A 9	- 50V*
B1	- 24V
B2	- 5V

\* ≈ - 64V when A70J3 is disconnected.

- c. Check the continuity of the fuse, F1.
- d. In order to check the operation of the switching supply the switching hybrid, U5 must be removed. This device must be unsoldered and removed by unscrewing the two screws holding it down, then gently pulling on the device.
- e. Connect 1/4 Watt, 100Ω resistor (-hp- Part Number 0683-1015) from the anode of CR3 to the negative side of C12.
- f. Turn the 3585 power on.
- g. Using an ac coupled oscilloscope check for a 2.5Vp-p square wave at the anode of CR3.
  - 1. If the 2.5Vp-p square wave is present, continue with step h.
  - 2. If the 2.5Vp-p signal is not present, the Probable Defect is U1, Q2, Q3 or CR3.\*\* Use the schematic to track the signal loss down.
- h. Connect variable supply to A74TP1.

\*\*If the stated devices check good, the problem is in the current limit circuitry. Continue with the troubleshooting procedure at step k to locate the problem.

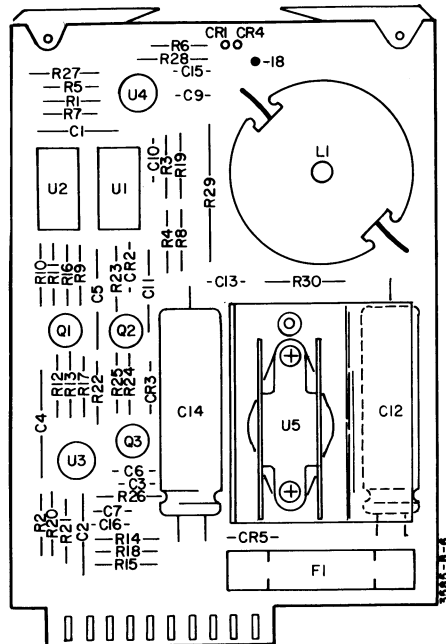
- i. Turn on the variable power supply and adjust it for  $-18.0V$ . The green LED should now be on.
  1. If the LED is on, continue at step j.
  2. If the LED is off or the power supply cannot be adjusted to  $+18V$ , the Probable Defect is the output capacitor C14, the reverse voltage protection diode CR5 or the overvoltage clamping diode A70CR1. Other possibilities are A74C13, A70C7, and A74CR4.
- j. Increase the voltage of the variable power supply by approximately one volt. Note the effect on the oscilloscope waveform as the voltage is increased (anode of CR3).
  1. If the negative portion of the oscilloscope waveform gets narrower, continue with step l.
  2. If there is no change in the oscilloscope waveform, go to step k.
- k. Check for  $\approx 2V_{p-p}$  riding on 24Vdc at U3(6).
  1. If the signal is present, the Probable Defect is U3.
  2. If no square wave is present the Probable Defect is Q1,U1,2,4. check for a TTL low at U2(6) and a TTL high at U2(1).
- l. Turn off the variable power supply. Adjust the voltage control for zero volts.
- m. Connect the variable power supply's positive lead to TP1 and the negative lead to a  $10k\Omega$ , 1/4 Watt resistor (-hp- Part Number 0683-1035) U4(2).
- n. Turn on the variable power supply. Slowly vary the voltage until the oscilloscope waveform goes to a positive level (dc level, no square wave), the yellow LED should now be on.
  1. If the LED lights and the square wave changes to dc, go to step o.
  2. If either condition does not occur, the Probable Defect is U1,2,4,CR1
- o. Turn off the variable power supply and the 3585.
- p. Remove the A74 board from the PC extender. Discharge C12 by shorting across it.



*Failure to discharge the aforementioned capacitor will destroy the new part you are about to put in.*

- q. Install a new U1 switching hybrid if everything has checked good to this point. Replace the board in the card nest.

- r. Turn on the 3585 power. The five green LED's on the power supplies should now be lit.
- s. Reconnect A76J6 and replace the PC hold-down bar and plastic cover for the power supplies.



A74  
03585-66574

## SERVICE GROUP J

### DISTORTION AND SPURS

The purpose of this section is to give you some guidelines to solve those problems which are related to either Distortion or Spurs. This section should not be used until after using the Preliminary Troubleshooting Procedure to check for other problems. Unless the instrument is operating correctly in all other respects, it is very difficult to isolate a problem related to Distortion or Spurs.

This section is broken up into two basic sections:

Section 1 — This section deals with the various types of distortion (i.e. Harmonic, IF and IM) and noise on both the High Impedance and Terminated channels.

Section 2 — This section primarily deals with Fractional N Spurs and their causes. Further guidelines are given on Conversion/Input and Reference Spurs.

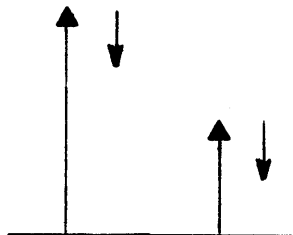
## SECTION I

### HARMONIC DISTORTION

Getting Started —

Distortion is almost invariably related to the Input/Conversion section; however, it is very important to determine that the distortion is being caused by the 3585 rather than the source connected to it. To confirm the source of the distortion, use the following procedure:

1. Input a signal to the 3585A whose amplitude is equal to the range (preferably 0dBm).
2. Adjust the source frequency until it is the same as the frequency where the distortion occurred.



3. Make a relative amplitude measurement between the fundamental and the second harmonic using the Offset Function.

4. "Zoom-in" on the second or third harmonic of the trace.
5. Deactivate the Ref Lvl Trk, Decrement the RANGE one step.
  - a. If the relative amplitude of the distortion product does not change significantly when the Range is incremented, the distortion is due to the source rather than the 3585A.
  - b. If the relative amplitude of the distortion product increases by  $\approx 5\text{dB}$  then the distortion is due to the 3585A.

#### NOTE

*A more detailed discussion of distortion measurement techniques is contained in Section III, Chapter 2 under "Improving The Noise-Free and Distortion-Free Dynamic Range".*

If the distortion is being caused by the 3585A and the distortion is  $< 80\text{dB}$  below signal then the following hints should help you locate the problem.

Always check:

- The base-to-emitter voltage on A1Q24,25. When these devices fail the output voltage only drops about 1V (to  $\pm 11\text{V}$ ), but cause a variety of problems.
- The levels of the Local Oscillator, 90MHz input and 10MHz input. If these levels are  $> 5\text{dB}$  lower than the stated value, Harmonic Distortion may be the result.
- The screws holding down the A1-5 boards are tight as well as those holding the shielding to the Input/Conversion casting.

### IM DISTORTION

Check:

- The base-to-emitter voltage on A1Q24,25. When these device fail the output voltage only drops about 1V (to  $\pm 11\text{V}$ ) which is enough to cause IM distortion.
- A1Q6 for  $1\text{M}\Omega$  IM Distortion problems. Also check that A1C52 is spaced approximately  $1/8''$  off of the PC board.

### NOISE

**1/F Noise, Low Frequency** — Remove the jumper connected to A1J4. Connect a  $50\Omega$  resistor between A2J3 and ground. Again check for 1/F noise, if it persists the probable defect is A2CR1. If the 1/F noise problem goes away then replace the jumper between A1 and A2. Ground the negative side of C93. If the 1/F noise returns, replace components within the A1 output amp, A1Q16,U6. Otherwise replace A1Q13,11.

**$1\text{M}\Omega$  Input Noise** — Probable due to the  $1\text{M}\Omega$  Input Buffer, particularly A1CR8,9,Q6.

**Noise vs. Bandwidth** — Using the Bandwidth and frequency at which the errors are occurring, follow the same elimination procedure outlined in the 1/F noise procedure.

<b>Frequency Range Of Fundamental When Distortion Occurs</b>	<b>Symptom</b>	<b>Probable Defect</b>
$\approx 2.6\text{kHz}$	bad third harmonic	A5 or A17. Check the output of A5 with a Spectrum Analyzer to determine where distortion is occurring. Probable defect on A5 is Q1, U1 or T4. Probable defect on A17 is Q1-3,7,8 or L6.
$\approx 70\text{kHz} - 2\text{MHz}$	bad second and third harmonic	A2L11 may need to be adjusted.
$\approx 70\text{kHz} - 2\text{MHz}$	good second, bad third harmonic	A4CR1. The distortion is caused within the mixer itself.
All frequencies	bad second harmonic	A1 or A2. Check the output of A1 using a Spectrum Analyzer to confirm the problem area. Probable defect on A1 is Q16,11. Probable defect on A2 is CR1 or U1.
	1M $\Omega$ input distortion	If the distortion is unique to the 1M $\Omega$ input the problem lies in the 1M $\Omega$ Buffer Amp (A1CR8,9,Q6).
	Underdriving by 5dB causes the distortion to go away	If the distortion changes by a factor considerable greater than the power law (5dB for 2nd harmonic, 10dB for third)the problem may be in the Autorange input amp, A1U7.

## SECTION II

### SPURIOUS RESPONSES

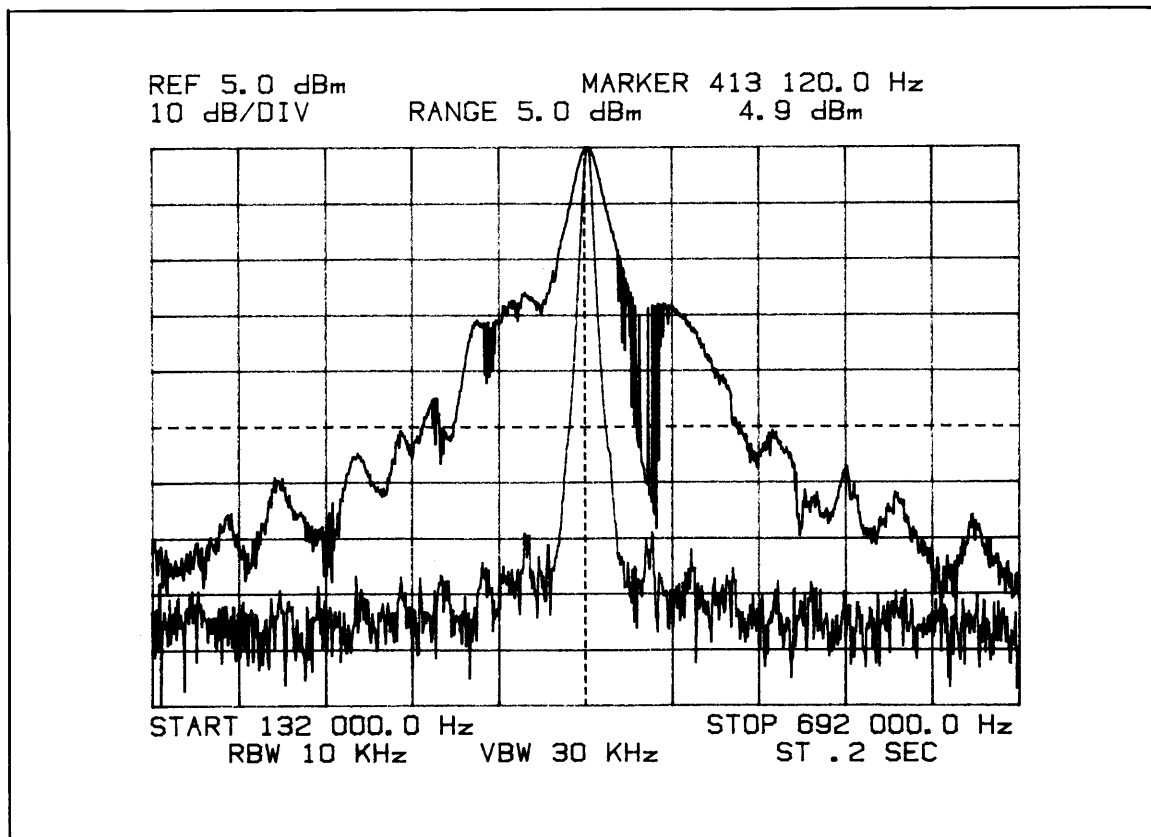
#### NOTE

*Covers on the A21-33 board must be screwed down tight to eliminate spurs in the 60-80db below signal region.*

#### Getting Started —

It is important to discover the cause of the spurious response. Two basic areas cause spurs: the Fractional N Synthesizer or the remainder of the Local Oscillator. Generally, spurs caused by the Fractional N Synthesizer will be within 200kHz of the input frequency and cause a response similar to Figure 11-J-1. This type of a response is usually very apparent in the 10kHz Res. BW; however, when the Res. BW is changed to 3kHz the spurious responses all but disappear. If this is your symptom then continue with the Fractional N Spur Troubleshooting procedure.

If the spurious response you are experiencing is a discrete response which is not similar to Figure 11-J-1, the problem is in the rest of the Local Oscillator. The most productive way to analyze this type of problem is to study the symptoms.

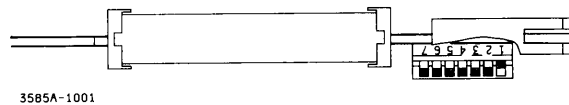


**Figure 11-J-1. Fractional N Spurs In 10kHz RBW**

- If the spurious response is always 2 to 3MHz above the input signal then begin to look for a problem in the Step Loop, particularly the A26 board.
- If the spurious response is always 700kHz below the input signal, the A5 board is probably causing the response. Usually this response is caused by a mistuned 9.65MHz notch filter.
- If the spurious response is always 20.7MHz below the input signal, the most likely cause is a mistuning of the 79.65MHz Image filter on the A3 board. If the problem cannot be solved by adjustment, troubleshoot the A4 board with a spectrum analyzer.
- If the spurious response is always 175kHz below the input signal, the most likely cause is the third mixer on the A5 board (A4U1).
- If the spurious response is at a constant frequency try to analyze the frequency in terms of the reference frequencies used in the instrument. The probable defect is an open capacitor on the A21 board.

**FRACTIONAL N SPUR TROUBLESHOOTING PROCEDURE**

- a. Set the 3585A to Test Mode D1 using the A45 test switches.



- b. Enter:

```
Instrument Preset
("Inst. Test Mode 01" should appear on the CRT)
Manual Entry.....450kHz
Res. BW.....10kHz
```

- c. Connect a 10:1 oscilloscope probe to A31TP2.  
Set the oscilloscope controls for:

```
Vertical.....0.01V/Div (ac coupled)
Horizontal.....50µsec/Div
```

- d. This is a cardinal frequency for the Fractional N. The API's are inactive at this time. Note the value of the oscilloscope waveform (normal operation gives a value <0.5Vp-p).

- e. Enter:

```
Manual Entry.....450.004kHz
```

- f. This is a non-cardinal frequency at which all the API's are operating. Note the value of the oscilloscope waveform.

1. If the values noted in steps d and f are approximately equal and <0.5Vp-p then the Fractional N is probably not producing the spurs.



- 2. If the non-cardinal frequency measurement (step f) is significantly worse than the cardinal frequency measurement (step d), then go to step g.
- 3. If both step d and f measure >0.5Vp-p and are approximately the same amplitude the probable defect is A32Q32,Q34,Q6,Q7,C9,C13,C14.
- g. Before checking the API's, it is important that we check for correct operation of the "pulse swallow" circuitry. Connect the oscilloscope to A33TP1.

h. Set the oscilloscope controls for:

Vertical.....0.2V/Div (dc coupled)  
 Horizontal..... 10µsec/Div

i. Enter:

Manual Entry.....449.999kHz

Approximately 4V peak pulses should now be occurring at a 100kHz rate. If the pulses are not occurring at a 100kHz rate, go to Service Group B-4 and troubleshoot the A33 board.

j. Enter:

Manual Entry.....450kHz

There should be no pulses occurring at A33TP1. Again, go the Service B-4 if pulses are occurring.

k. The problem is most likely occurring in the A32 board API's. To determine which API is causing the problem, monitor A31TP2 with the oscilloscope. Watch the oscilloscope while entering each of the frequencies listed below. These frequencies add each API in succession. The point at which the waveform at A31TP2 gets significantly worse indicates which API is faulty. Check step l for furth instructions.

Manual Frequency	Active API
450kHz	none
490kHz	API 1
454kHz	API 2
450.4kHz	API 3
450.04kHz	API 4
450.004kHz	API 5

l. Enter:

Manual Entry.....450.004kHz

Check for pulses of varying width (10 discrete steps) at A32U1(4,14,13,11,6). You need only check the line associated with the faulty API.

- m. Check for pulses of varying width at A32U1(5,15,12,10,7).
- n. Check the base-to-emitter voltage drops of Q8,9 and 11. If everything has checked good to this point, other possibilities are A32,U2,U3,Q7,Q32,Q34,C13,C14,C9, Q6.

## CATHODE-RAY TUBE FAILURE REPORT

(This form must accompany all warranty claims and MFR/HEART credit claims.)

Date \_\_\_\_\_

Submitted By (Name) \_\_\_\_\_

Name of Company \_\_\_\_\_

Address \_\_\_\_\_

1. Hewlett-Packard Instrument Model No. \_\_\_\_\_

2. Hewlett-Packard Instrument Serial No. \_\_\_\_\_

3. Defective CRT Serial No. \_\_\_\_\_ Part No. \_\_\_\_\_

4. Replacement (New) CRT Serial No. \_\_\_\_\_

5. Please describe the failure and, if possible, show the trouble on the appropriate CRT face below.

\_\_\_\_\_

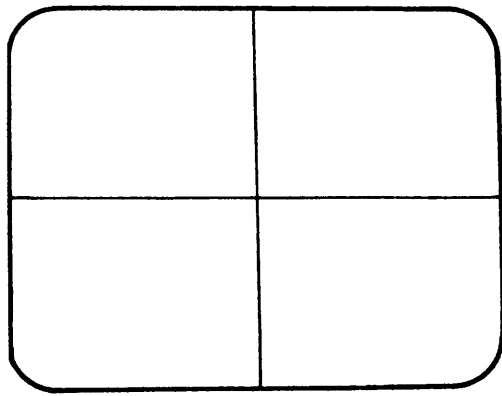
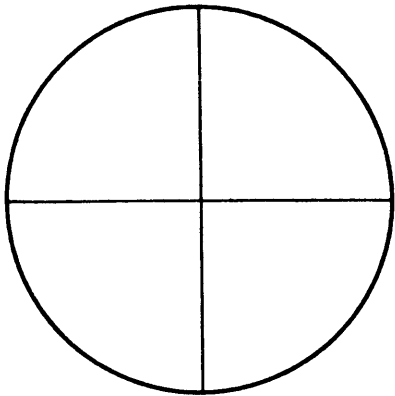
\_\_\_\_\_

\_\_\_\_\_

\_\_\_\_\_

\_\_\_\_\_

\_\_\_\_\_



6. Is a warranty claim being made? \_\_\_\_\_

7. Hewlett-Packard Sales/Service Office \_\_\_\_\_

8. MFR, HEART or Customer Service Order Number \_\_\_\_\_